



**MODEL REGULATION GUIDELINES -
SUPPORTING INFORMATION**

SEPTEMBER 2019

ENERGY-EFFICIENT AND CLIMATE-FRIENDLY AIR CONDITIONERS



Acknowledgements

The lead authors, Brian Holuj of UNEP's United for Efficiency Initiative, Won Young Park and Nihar Shah of Lawrence Berkeley National Laboratory, and Noah Horowitz and Alex Hillbrand of the Natural Resources Defense Council would like to thank the following for their valuable contributions as reviewers:

Rashid Ali Abdallah, African Energy Commission
Atef Marzouk, African Union Commission - Energy Division
Fatih Demiray, Arçelik A.Ş.
Li Pengcheng, China National Institute of Standardization
Marie Baton, CLASP
Naomi Wagura, CLASP
Hilde Dhont, Daikin Europe
Philipp Munzinger, GIZ
Miriam Frisch, GIZ
Michael Kiza, East African Centre of Excellence for Renewable Energy and Efficiency
Charles Diarra, ECOWAS Centre for Renewable Energy and Energy Efficiency
Viktor Sundberg, Electrolux
S.P. Garnaik, Energy Efficiency Services Limited
Han Wei, Energy Foundation China
Antoine Durand, Fraunhofer ISI
Nora Steurer, Global Alliance for Buildings and Construction
Miquel Pitarch, HEAT
Bassam Elassaad, Independent Consultant
Anett Matbadal, Independent Consultant
James Wolf, Independent Consultant
Frank Gao, International Copper Association
Kerry Song, International Copper Association
Hal Stillman, International Copper Association
Kevin Lane, International Energy Agency
John Dulac, International Energy Agency
Chiara Delmastro, International Energy Agency
Sommai Phon-Amnuaisuk, International Institute for Energy Conservation
Didier Coulomb, International Institute of Refrigeration
Norio Takahashi, Johnson Controls - Hitachi Air Conditioning
Gabrielle Dreyfus, Kigali Cooling Efficiency Program
Dae Hoon Kim, Korea Refrigeration & Air Conditioning Assessment Center
Hee Jeong Kang, Korea Refrigeration & Air Conditioning Assessment Center

Jinho Yoo, Korea Refrigeration & Air Conditioning Assessment Center
Jun Young Choi, Korea Testing Laboratory
Bum Young Kim, LG Electronics
Tony Hong, LG Electronics
Juan Rosales, Mabe
Takashi Okazaki, Mitsubishi Electric US
Fabio García, Organización Latinoamericana de Energía (OLADE)
Jaime Guillén, Organización Latinoamericana de Energía (OLADE)
Asad Mahmood, Pakistan National Energy Efficiency & Conservation Authority
Sara Ibrahim, Regional Center for Renewable Energy and Energy Efficiency
Maged Mahmoud, Regional Center for Renewable Energy and Energy Efficiency
Kudakwashe Ndhlukula, SADC Centre for Renewable Energy and Energy Efficiency
Hong Seok Jun, Samsung Electronics
Hyun Seok Jung, Samsung Electronics
Yongsik Cho, Samsung Electronics
Lin-Jie Huang, Sanhua Holding Group
Ousmane Sy, Senegalese Association of Engineers and Refrigeration Technicians
Stephen Cowperthwaite, UK Department for Environment, Food and Rural Affairs
Helena Rey De Assis, UNEP Sustainable Tourism
Madeleine Edl, UNEP U4E
Marco Duran, UNEP U4E
Patrick Blake, UNEP U4E
Paul Kellett, UNEP U4E
Souhir Hammami, UNEP U4E
Eric Antwi-Agyei, UNEP U4E ECOWAS Refrigerators and ACs Initiative
Morris Kayitare, UNEP U4E Rwanda Cooling Initiative
Paul Waide, Waide Strategic Efficiency
Marco Spuri, Whirlpool
Ashok Sarkar, World Bank Group
Omar Abdelaziz, Zewail City of Science and Technology

Foreword

This document provides context on the rationale underpinning the Model Regulation Guidelines for Energy-Efficient and Climate-Friendly Air Conditioners. It includes a brief explanation of the scope, product categories, and market and policy trends in energy efficiency and refrigerants. The Model Regulation Guidelines refer to commonly used international standards such as International Organization for Standardization (ISO) 16358 and ISO 5151 for testing and seasonal efficiency metrics. Countries need to be familiar with either these standards or other approaches that they intend to pursue for their regulatory framework.

Air conditioners expend a considerable amount of electricity during normal use, and there is a significant opportunity to cost-effectively improve energy efficiency and transition to lower global warming potential (GWP) refrigerants. United for Efficiency (U4E) has produced Country Savings Assessments (updated as of September 2019) for 150 developing and emerging economies, which project annual electricity savings, greenhouse gas (GHG) emissions reductions, and utility bill savings for consumers if the countries adopt the Model Regulation Guidelines.¹ The following table draws from the Assessments to provide examples of the estimated annual impacts in 2030 if all countries in the sample regions were to adopt the proposed minimum energy efficiency and refrigerant requirements. Various combinations of countries, beyond the simplified list below, can be considered by reviewing the full set of Country Savings Assessments.

Estimated Annual Savings starting in 2030 based on the Minimum Ambition (MEPS) Scenario				
Region	Electricity (Twh)	Power Plants (500MW each)	CO2 (Million tonnes)	Financial - Electricity Bill (Million USD)
Central America	4.4	2	3	518.5
Africa	30.3	14	20	2710.4
South East Asia	76.7	35	52.8	8301.7
West Asia	34.2	16	28.3	2466.2

While shading, natural ventilation, insulation, reflective coatings, and other design and operational approaches should be used to reduce indoor temperatures and improve comfort, air conditioners remain essential in many applications. On warm days in hot climates, air conditioning can account for over half of the load on the electrical grid. This spike, which is often met by running additional fossil-fuel power plants, drives up costs, jeopardizes grid stability, and exacerbates pollution. It is therefore recommended that in addition to reducing thermal loads, countries adopt mandatory MEPS and labels informed by the Model Regulation Guidelines.

¹ Country Savings Assessments are available at <https://united4efficiency.org/countries/country-assessments>

Disclaimer

The designations employed and the presentation of the material in this publication do not imply the expression of any opinion whatsoever on the part of the United Nations Environment Programme concerning the legal status of any country, territory, city or area or of its authorities, or concerning delimitation of its frontiers or boundaries. Moreover, the views expressed do not necessarily represent the decision or the stated policy of the United Nations Environment Programme, nor does citing of trade names or commercial processes constitute endorsement.

The information contained within this publication may be subject to change without notice. While the authors have attempted to ensure that the information has been obtained from reliable sources, the United Nations Environment Programme is not responsible for any errors or omissions, or for the results obtained from the use of this information. All information is provided on an “as-is” basis with no guarantee of completeness, accuracy, timeliness or of the results obtained from the use of this information, and without warranty of any kind, express or implied, including, but not limited to warranties of performance, merchantability and fitness for a particular purpose.

In no event will the United Nations Environment Programme, its related corporations, contributors, or the partners, agents or their respective employees have any liability to you or anyone else for any act and conduct in connection with or related to the information provided herein. This disclaimer applies to any damages or liability and in no event will the United Nations Environment Programme be liable to you for any indirect, consequential, exemplary, incidental or punitive damages, including lost profits, even if we have been advised of the possibility of such damages.

For more information, contact:

**United Nations Environment Programme –
United for Efficiency initiative**

Economy Division
Energy, Climate, and Technology Branch
1 Rue Miollis, Building VII
75015, Paris
FRANCE
Tel: +33 (0)1 44 37 14 50
Fax: +33 (0)1 44 37 14 74
E-mail: u4e@un.org
<http://united4efficiency.org/>

Table of Contents

Acknowledgements.....	i
Foreword.....	ii
Disclaimer.....	iii
1. Model Regulation Guideline Scope and Product Categories	1
2. Examples of Energy-Efficiency Performance Requirements.....	3
3. Benchmarking the Model Regulation Guidelines	6
4. Market Availability and Recognition of Energy-Efficient AC Systems.....	9
5. Developing Outdoor Temperature Bin Hours for AC Use.....	14
6. Rating Performance of ACs in Regional Metrics	16
7. Considerations of Product Availability and Cost.....	19
8. Charge Size Limitation for Flammable (A3) Refrigerants.....	21
References	23

List of Tables

Table 1: Product categories by CC (in kW) considered in the Model Regulation and regional standards ...	2
Table 2: China’s energy-efficiency label grade thresholds for fixed-speed ACs	3
Table 3: China’s energy-efficiency label grade thresholds for variable-speed ACs	3
Table 4: China’s new efficiency grade thresholds for ACs, effective late 2019 to 2022.....	4
Table 5: Model Regulation minimum requirements for cooling-only ACs	6
Table 6: Model Regulation minimum requirements for reversible heat pumps.....	6
Table 7: Highest-efficiency ACs in selected economies	12
Table 8: Summary of specifications of three AC models	18
Table 9: Refrigerant charge size limits for HCs safety standards, for ACs and heat pumps	21
Table 10: Examples of low-GWP alternatives for stationary ACs	22

List of Figures

Figure 1: Market share of ACs by technology and refrigerant in 2017.....	4
Figure 2: Improvement in China AC MEPS and labels.....	5
Figure 3: Comparison of AC MEPS in selected economies	9
Figure 4: Efficiency in ISO CSPF estimated for VSD ACs available in selected economies.....	10
Figure 5: Efficiency of most-efficient models relative to MEPS or least-efficient labels.....	12
Figure 6: Comparison of high and low efficiency grades of the Model Regulation Guidelines, regional standards, and BAT	14
Figure 7: Outdoor temperature distributions of extremely hot to warm climate regions (0A to 3C).....	15
Figure 8: Annual outdoor temperature bin hours (brown) and temperature bin hours assumed for AC use in 0A climate regions (blue)	16
Figure 9: Relationship between China APF (from GB 21455-2013) and ISO APF with 2A temperature bin hours	17
Figure 10: TEWI calculation results for three AC models	19
Figure 11: Price vs. efficiency of 1-RT and 2-RT ACs in China and India	20

Acronyms

AC	air conditioner	IPCC	Intergovernmental Panel on Climate Change
APF	annual performance factor	ISEER	India seasonal energy-efficiency ratio
ASHRAE	American Society of Heating, Refrigerating and Air-Conditioning Engineers	ISO	International Organization for Standardization
BAT	best available technology	LBNL	Lawrence Berkeley National Laboratory
CARICOM	Caribbean Community	MEPS	minimum efficiency performance standards
CC	cooling capacity	NOM	Official Mexican Standard
CO ₂ e	carbon dioxide equivalent	REEE	Relación de Eficiencia Energética Estacional (Mexico's SEER)
COP	coefficient of performance	RMB	renminbi
CSPF	cooling seasonal performance factor	RSEER	Rwanda SEER
EER	energy-efficiency ratio	RT	refrigeration ton
EN	European Standard	S&L	standards and labelling
EOL	end-of-life	SASO	Saudi Standards, Metrology and Quality Organization
EU	European Union	SEER	seasonal energy-efficiency ratio
FSD	fixed-speed drive	TEWI	total equivalent warming impact
GB	Guóbiāo (Chinese national standard)	U4E	United for Efficiency
GHG	greenhouse gas	U.S.	United States
GWP	global warming potential	USD	U.S. dollars
HC	hydrocarbons	VRF	variable refrigerant flow
HCFC	hydrochlorofluorocarbon	VSD	variable-speed drive
HFC	hydrofluorocarbon	WCOP	weighted coefficient of performance
HFO	hydrofluoroolefin		
IEC	International Electrotechnical Commission		

1. Model Regulation Guideline Scope and Product Categories

The majority of AC systems for residential or light commercial use have a cooling capacity (CC) of up to 10.5 kW, equivalent to three refrigeration tons (RT).² The scope of energy-efficiency standards for these AC systems varies by region, for example:

- Japan: up to 7.1 kW (2 RT)
- India: up to 11 kW (3 RT)
- European Union (EU): up to 12 kW (3.4 RT)
- China: up to 14 kW (4 RT)
- Mexico: up to 19 kW (5.4 RT)
- Saudi Arabia: up to 20.5 kW (5.8 RT)
- Republic of Korea³: up to 23 kW (6.6 RT)

This Model Regulation sets an upper limit of 4.5 RT (16 kW) to cover the majority of AC systems, including heat pumps, for residential and light commercial use. Given that China represents about 40 per cent of global room AC sales and 70 per cent of global room AC production (International Energy Agency 2019; ChinaIOL 2018; Japan Refrigeration and Air Conditioning Industry Association [JRAIA] 2018a), the Model Regulation Guidelines categorize AC systems by CC, similar to the China standards and labelling (S&L) program. The aim is to minimise confusion by setting nominal kW and RT values, e.g., 3.5 kW/1 RT, 7.0 kW/2 RT, and 10.5 kW/3 RT, to be included within each category, not as thresholds (Table 1).

² RTs indicate the nominal CC of the equipment where 1 RT = 12,000 Btu/h = 3.52 kW.

³ Also known as South Korea.

Table 1: Product categories by CC (in kW) considered in the Model Regulation and regional standards

Model Regulation	Small CC ≤ 4.5	Medium 4.5 < CC ≤ 9.5	Large 9.5 < CC ≤ 16.0
Nominal size by CC (RT)	2.6 kW (0.75 RT) 3.5 kW (1 RT)	5.3 kW (1.5 RT) 7.0 kW (2 RT)	10.5 kW (3 RT) 14.0 kW (4 RT)

The chart displays the cooling capacity ranges for different regions and the Model Regulation. The x-axis represents Cooling Capacity in kW, ranging from 0 to 25. The y-axis lists the regions: Republic of Korea, Japan, Mexico, EU, China, and Model Regulation. The Model Regulation bar is divided into three segments: Small (CC ≤ 4.5), Medium (4.5 < CC ≤ 9.5), and Large (9.5 < CC ≤ 16.0). The Republic of Korea has the highest cooling capacity range, extending to approximately 23 kW. Japan, Mexico, EU, and China have ranges ending at approximately 7, 19, 12, and 14 kW, respectively.

Note: The select economies set different S&L requirements by CC.

AC products for residential and light commercial use are typically categorized by type (e.g., split/self-contained, cooling-only/reversible, and fixed-speed/variable-speed) and size by CC. Some countries—such as Brazil, India, Indonesia, and the United States (U.S.)—do not differentiate the S&L requirements by CC; that is, S&L requirements do not decrease as CC increases. However, others—such as China, the EU, Japan, Mexico, and the Republic of Korea—set different S&L requirements by CC, because the energy efficiency of AC compressors (e.g., rotary compressors) tends to decrease as the size (CC) increases.

Major AC manufacturers typically optimize compressor efficiency by taking advantage of the fact that variable-speed compressors⁴ can operate at a wide range of frequencies (Park, Shah, and Gerke 2017). The highest-efficiency ACs are typically available in small sizes, particularly with 0.75-RT (2.5–2.6 kW CC) products, except in India, where the most efficient model is a 1-RT model, and in the Republic of Korea, where the most efficient model is a 2-RT model (Park, Shah, and Gerke 2017).

⁴ Variable-speed compressors are also known as inverter-driven compressors.

2. Examples of Energy-Efficiency Performance Requirements

Current minimum energy performance standards (MEPS) in many emerging and developing economies—such as Brazil, India, Indonesia, Mexico, and South Africa—are in a range equivalent to an energy-efficiency ratio (EER) of 3.00–3.20 W/W, similar to China’s MEPS for fixed-speed units that has been effective since 2010. China categorizes split room ACs into fixed-speed and variable-speed types, with different MEPS and mandatory energy-efficiency labelling thresholds set for each product category under different standards. China also evaluates the energy efficiency of fixed-speed ACs using EER. The Chinese efficiency metrics for variable-speed ACs are a seasonal energy-efficiency ratio (SEER) for cooling-only products and an annual performance factor (APF) for reversible heat pumps. Table 2 presents China’s energy-efficiency grades for fixed-speed ACs in EER. Table 3 presents the grades for variable-speed ACs in SEER and APF.

Table 2: China’s energy-efficiency label grade thresholds for fixed-speed ACs

Type	CC	Grade 1	Grade 2	Grade 3
Split (EER)	CC ≤ 4.5 kW	3.60	3.40	3.20
	4.5 kW < CC ≤ 7.1 kW	3.50	3.30	3.10
	7.1 kW < CC ≤ 14.0 kW	3.40	3.20	3.00

Source: Park, Shah, and Gerke (2017)

Table 3: China’s energy-efficiency label grade thresholds for variable-speed ACs

Type	CC	Grade 1	Grade 2	Grade 3
Split, Cooling Only (SEER)	CC ≤ 4.5 kW	5.40	5.00	4.30
	4.5 kW < CC ≤ 7.1 kW	5.10	4.40	3.90
	7.1 kW < CC ≤ 14.0 kW	4.70	4.00	3.50
Split, Reversible (APF)	CC ≤ 4.5 kW	4.50	4.00	3.50
	4.5 kW < CC ≤ 7.1 kW	4.00	3.50	3.30
	7.1 kW < CC ≤ 14.0 kW	3.70	3.30	3.10

Source: Park, Shah, and Gerke (2017)

The share of variable-speed ACs sold in China increased from 10–18 per cent in 2010 to 58–65 per cent in 2018 (ChinaIOL 2018; JRAIA 2018b). Reversible heat pumps are dominant among variable-speed units sold in the market. China’s move toward variable-speed units is part of a global trend driven by advances in information technology and semiconductor manufacturing, which have reduced costs, and the adoption of seasonal efficiency metrics. In 2017, nearly 100 per cent of ACs sold in almost all AC categories in North America, Europe, and Japan had variable-speed compressors that use hydrofluorocarbon (HFC) refrigerants.

Penetration of variable-speed products in developing and emerging economies is generally still low. Most products in developing economies are fixed-speed units that use hydrochlorofluorocarbon (HCFC) refrigerants and have low upfront costs but are relatively inefficient (JRAIA 2018b); see Figure 1. However, in Brazil, India, and South Africa, the share of

variable-speed units in new sales has grown to 30–60 per cent of the markets as of 2018 (Technical Committee Meeting 2019; United Nations Development Programme 2019; Kigali Cooling Efficiency Program 2019).

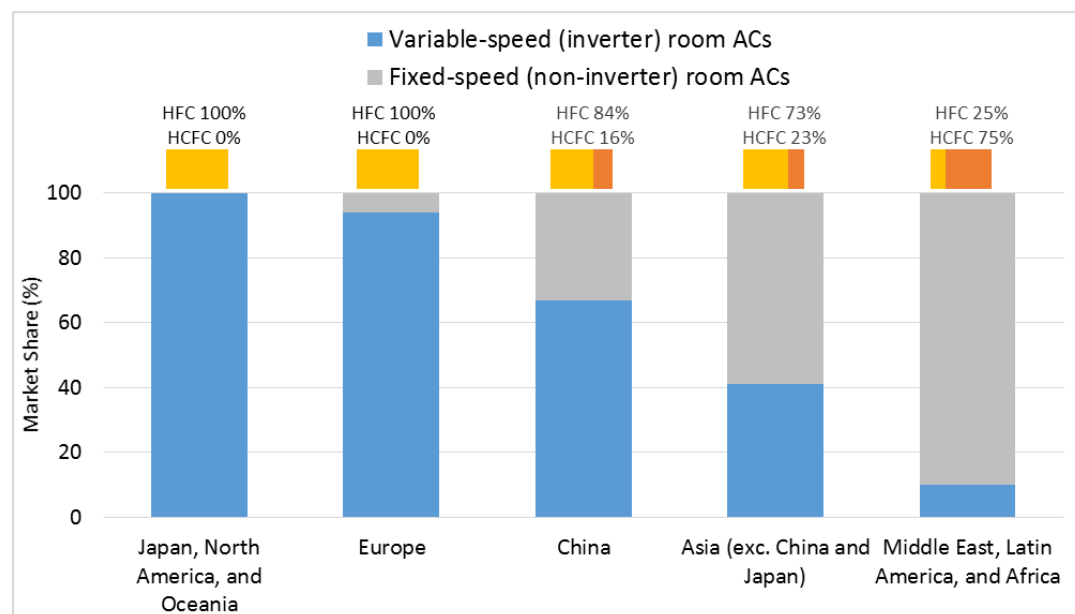

Figure 1: Market share of ACs by technology and refrigerant in 2017

Source: Park (2019)

HCFC = hydrochlorofluorocarbon, HFC = hydrofluorocarbon

Note: The energy efficiency of room AC technologies continues to improve through advances in research and development and manufacturing processes.

China is in the process of revising its MEPS and labels at the time of this drafting. Phase I of the proposed standard includes five grades covering both fixed- and variable-speed ACs, with Grade 5 being the threshold for fixed-speed units and Grade 3 being the threshold for variable-speed units (Table 4). Phase I is expected to be effective between late 2019 and 2021. It is then expected to be revised with Phase II in 2022, with Grade 3 being the threshold for both types (China National Institute of Standardization 2019). The proposed 2022 MEPS are estimated to be 32–54 per cent more stringent than the 2010 MEPS for fixed-speed units in China SEER (Figure 2).

Table 4: China’s new efficiency grade thresholds for ACs, effective late 2019 to 2022

Type	CC	Grade 1	Grade 2	Grade 3	Grade 4	Grade 5
Split, Cooling Only (SEER)	CC ≤ 4.5 kW	5.80	5.40	5.00	3.90	3.70
	4.5 kW < CC ≤ 7.1 kW	5.50	5.10	4.40	3.80	3.60
	7.1 kW < CC ≤ 14.0 kW	5.20	4.70	4.00	3.70	3.50
Split, Reversible (APF)	CC ≤ 4.5 kW	5.00	4.50	4.00	3.50	3.30
	4.5 kW < CC ≤ 7.1 kW	4.50	4.00	3.50	3.30	3.20
	7.1 kW < CC ≤ 14.0 kW	4.20	3.70	3.30	3.20	3.10

Source: China National Institute of Standardization (2019)

Note: Grade 5 and Grade 3 become the minimum requirement thresholds for fixed-speed and variable-speed units in Phase I (late 2019–2021). Grade 3 becomes the minimum requirement threshold for both types in 2022.

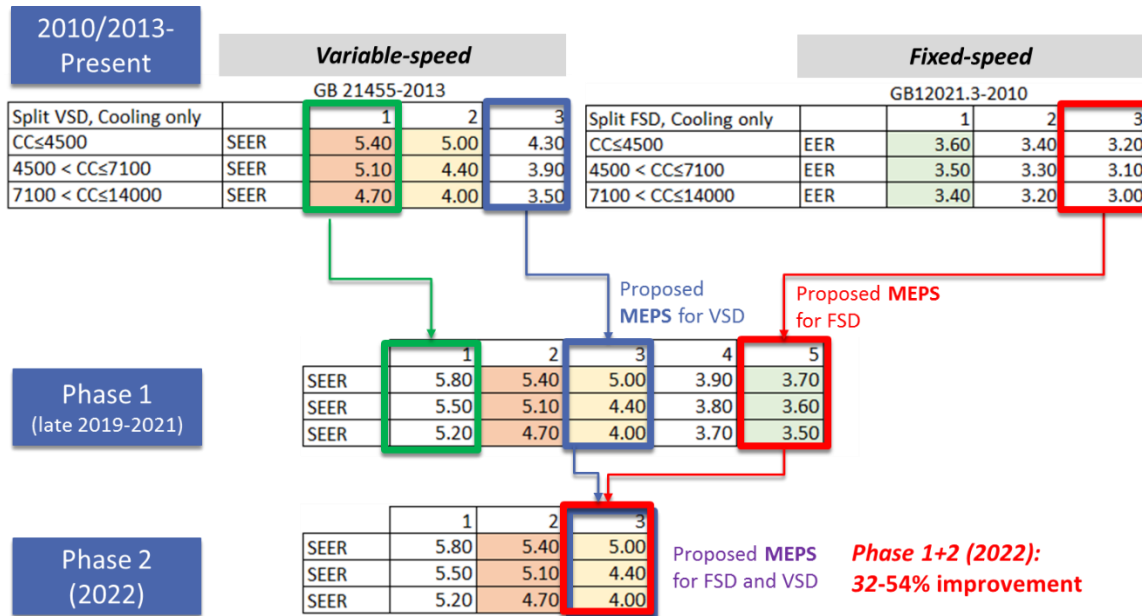

(a) Cooling-only ACs

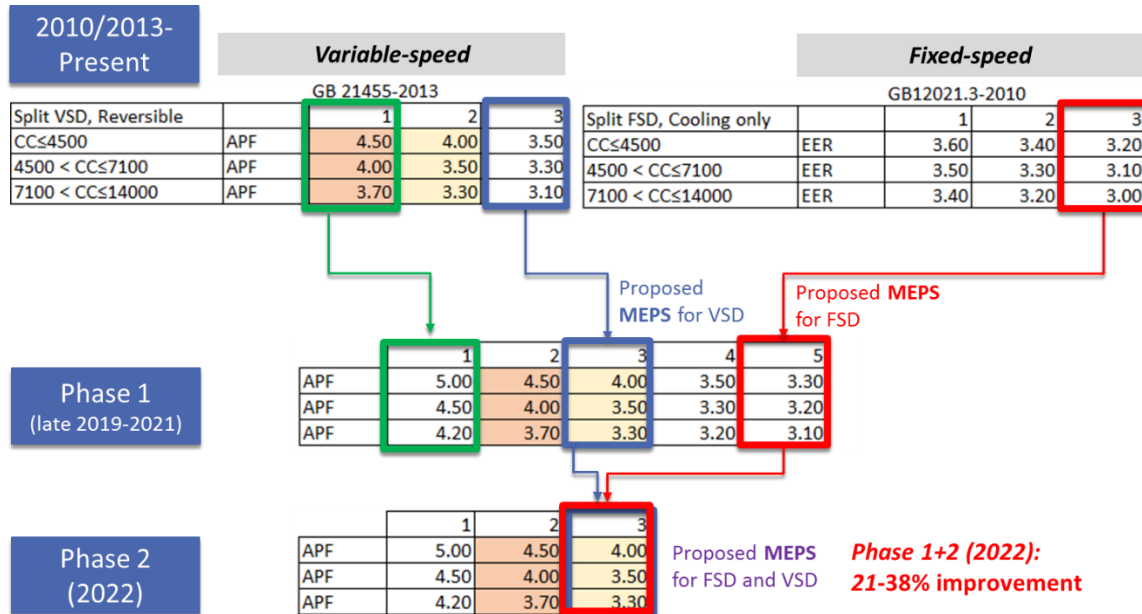

(b) Reversible heat pumps

Figure 2: Improvement in China AC MEPS and labels

Source: Lawrence Berkeley National Laboratory [LBNL] analysis

CC in watts

FSD = fixed-speed drive, VSD = variable-speed drive

Note: The revised MEPS and labelling requirements in Phase 1 and 2 apply to split and window types.

3. Benchmarking the Model Regulation Guidelines

The Model Regulation Guidelines suggest requirements to be consistent with the market transition expected from technology and policy improvements in China and other major emerging economies. Table 5 and Table 6 show the Model Regulation Guidelines minimum requirements (low efficiency grade) in ISO cooling seasonal performance factor (CSPF) and annual performance factor (APF) with comparable China 2022 MEPS for ACs and heat pumps. Figure 3 shows a comparison of the Model Regulation Guidelines minimum requirements (low efficiency grade) for ACs with select economies.

Table 5: Model Regulation minimum requirements for cooling-only ACs

	China SEER	Group 1	Group 2	Group 3
		ISO CSPF ^a (0A/1A/2A/3A/2B/3B/3C climates)	ISO CSPF ^b (0B/1B climates)	ISO CSPF ^c (4A/5A/6A/4B/5B/6B/7/8 climates)
CC ≤ 4.5 kW	5.00	6.10 (4.90–6.00)	5.00 (4.60–4.70)	5.30 (4.70–6.70)
4.5 kW < CC ≤ 9.5 kW	4.40	5.10 (4.30–5.10)	4.30 (4.00–4.10)	4.60 (4.20–5.10)
9.5 kW < CC ≤ 16.0 kW	4.00	4.50 (4.00–4.50)	3.80 (3.70)	4.10 (3.90–4.50)

CSPF = cooling seasonal performance factor

^a Group 1's ISO CSPF is based on ISO 16358-1:2013 and the reference temperature bin hours.

^b Group 2's ISO CSPF is based on ISO 16358-1:2013/Amd 1:2019 and the reference temperature bin hours.

^c Group 3's ISO CSPF is based on ISO 16358-1:2013 and Group 3's temperature bin hours in the U4E Model Regulation Guidelines.

Table 6: Model Regulation minimum requirements for reversible heat pumps

	China APF	Group 1	Group 2	Group 3
		ISO APF ^a (1A/2A/3A/2B/3B/3C climates)	ISO APF ^b (0B/1B climates)	ISO APF ^c (4A/5A/6A/4B/5B/6B/7/8 climates)
CC ≤ 4.5 kW	4.00	5.00 (4.40–5.20)	4.00 (3.90–4.00)	3.10 (3.10–3.60)
4.5 kW < CC ≤ 9.5 kW	3.50	4.00 (3.70–4.10)	3.60 (3.50–3.60)	2.50 (2.50–3.00)
9.5 kW < CC ≤ 16.0 kW	3.30	3.60 (3.40–3.60)	3.40 (3.30–3.40)	2.30 (2.30–2.80)

^a Group 1's ISO APF is based on ISO 16358-1:2013, 16358-2:2013, and the reference temperature bin hours (cooling and heating).

^b Group 2's ISO APF is based on ISO 16358-1:2013/Amd 1:2019, 16358-2:2013, and the reference temperature bin hours (cooling and heating).

^c Group 3's ISO APF is based on ISO 16358-1:2013, 16358-2:2013 and Group 3's temperature bin hours in the U4E Model Regulation Guidelines.

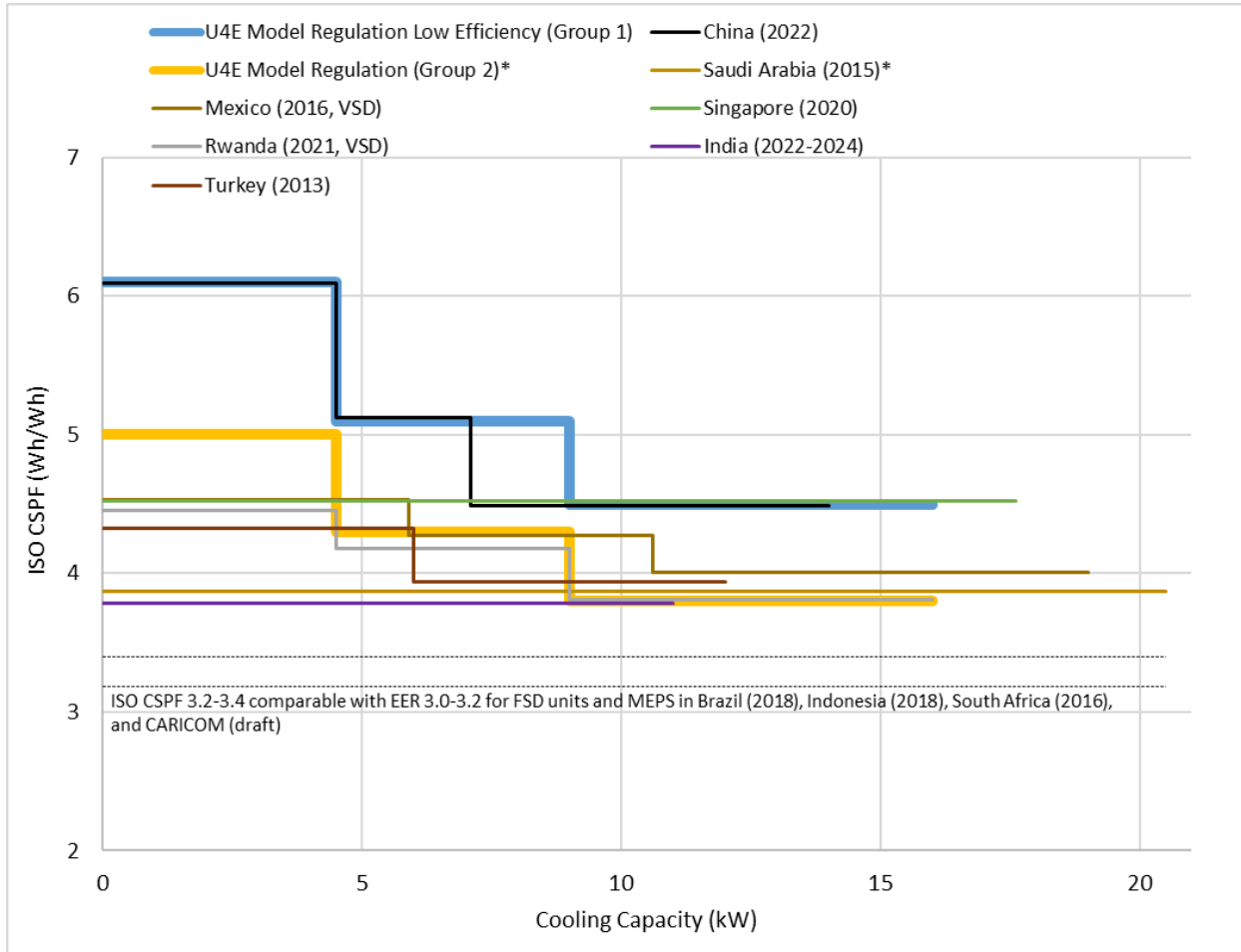

(a) All capacity

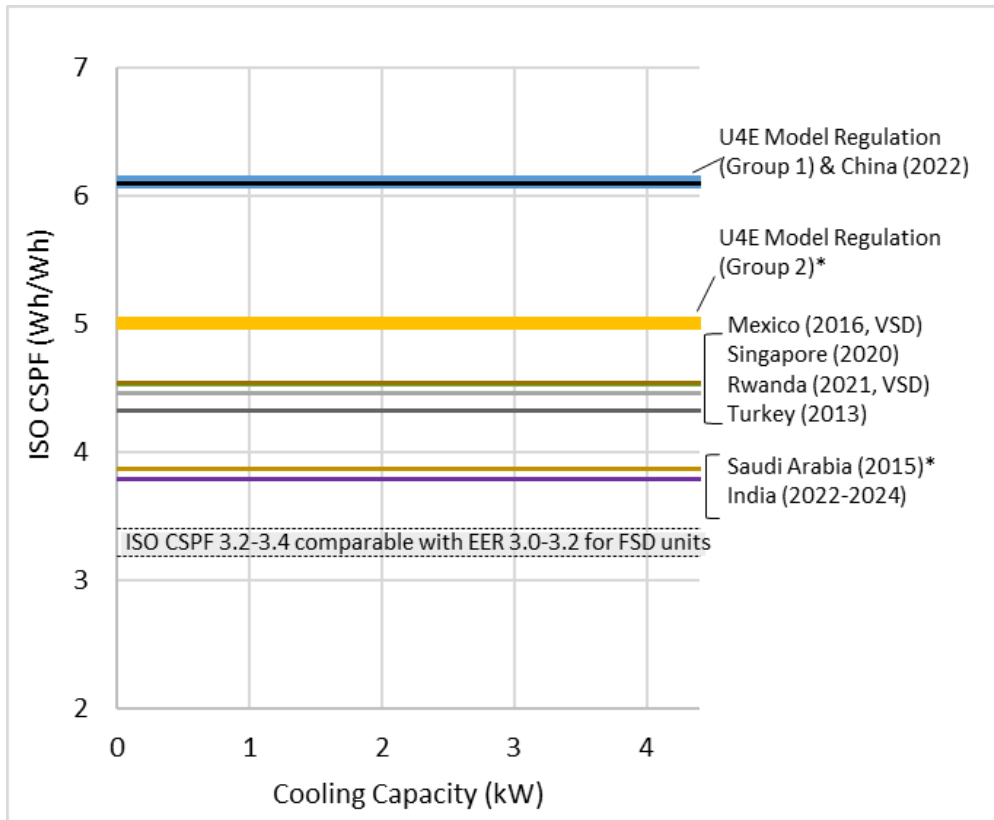

(b) Small capacity

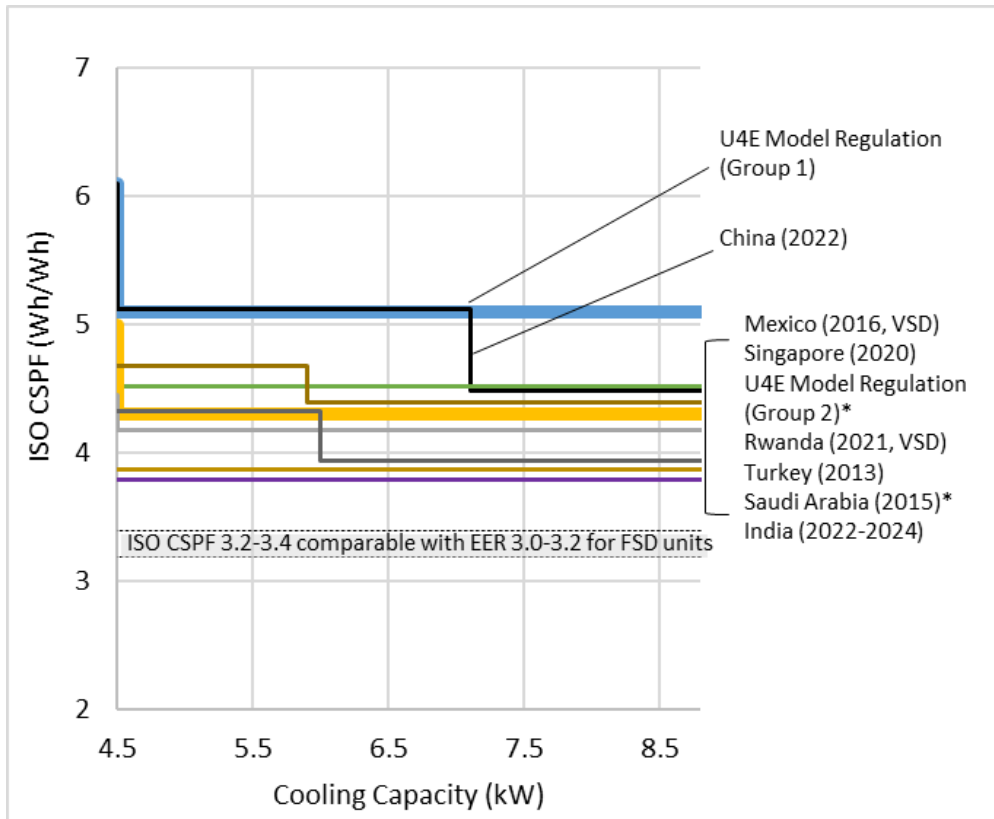

(c) Medium capacity

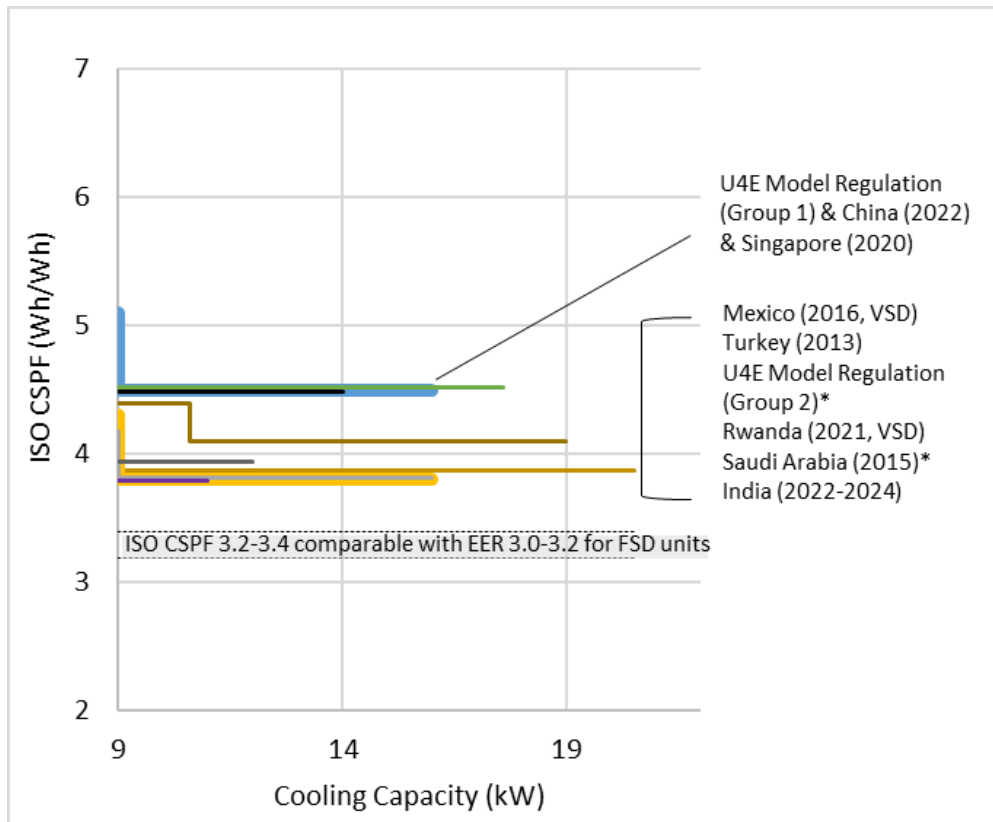

(d) Large capacity

Figure 3: Comparison of AC MEPS in selected economies

Source: LBNL analysis

CARICOM = Caribbean Community; ISEER = India SEER; REEE = Relación de Eficiencia Energética Estacional, Mexican SEER; WCOP = weighted coefficient of performance

Notes: The asterisks denote ISO CSPF in accordance with ISO 16358-1:2013/Amd 1:2019 based on the T3 standard CC rating conditions for hot climates at outdoor dry bulb temperature of 46°C (114.8°F), and the T1 standard CC rating conditions for moderate climates at outdoor dry bulb temperature of 35°C (95°F).

Saudi Arabia – ISO CSPF (T3) estimated from EER 3.37 (T1) and EER 2.43 (T3) for split type in the national standard (SASO 2663/2014).

Mexico – ISO CSPF estimated from REEE 4.68/4.39/4.10 by CC for VSD split type in the national standard (NOM-026-ENER-2015).

Singapore – ISO CSPF estimated from WCOP 3.8 for split type.

Rwanda – ISO CSPF estimated from Rwanda SEER (RSEER) 3.80/3.50/3.20 by CC for VSD split type in the national cooling strategy.

India – ISO CSPF estimated from ISEER 3.5 for split type suggested at the 11th Technical Committee meeting for room ACs (Technical Committee Meeting 2019).

Turkey – ISO CSPF estimated from EU SEER 4.6 (up to 6 kW CC) and 4.3 (6-12 kW CC).

ISO CSPF 3.2–3.4 (comparable with EER 3.0–3.2 for FSD units) is the level equivalent or similar to the current MEPS effective in many developing economies, e.g., Brazil (2018), Mexico for FSD units (2018), South Africa (2016), and CARICOM (draft).

4. Market Availability and Recognition of Energy-Efficient AC Systems

Although the majority of FSD AC models are unlikely to meet the China 2022 MEPS and the Model Regulation Guidelines efficiency requirements, 12–26 per cent of VSD AC models currently

available in major emerging economies are estimated to meet the levels proposed for 2022 (China) or 2023 (Model Regulation Guidelines); see Figure 4.

The expected market and technology transition via S&L in major emerging economies provides an important policy signal to manufacturers that also sell to markets that are the target of the Model Regulation Guidelines: those with outdated, unenforced, or no MEPS and labels. A common set of requirements will help manufacturers prepare to offer products that can be sold in a larger set of markets, with an aim to unlock greater economies of scale so that energy-efficient solutions are widely accessible. Combining the transition toward higher efficiency with the transition toward low-GWP refrigerants would allow the industry to exploit synergies in redesigning equipment and retooling manufacturing lines to achieve both goals simultaneously.

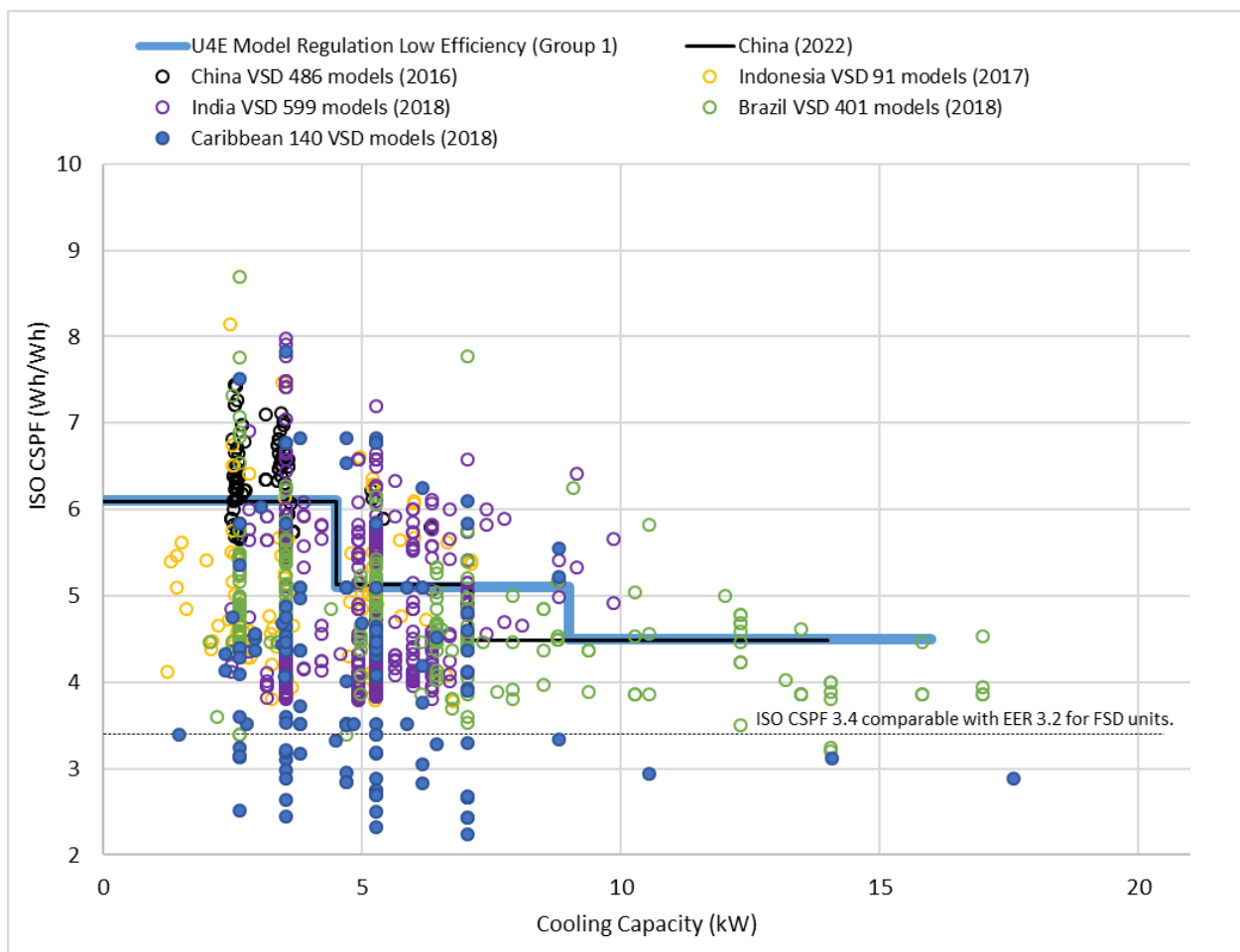

Figure 4: Efficiency in ISO CSPF estimated for VSD ACs available in selected economies

Source: LBNL analysis

Note: 24–26 per cent of VSD AC models available in China (as of 2016), Indonesia (as of 2017), and India (as of 2018) are estimated to meet the levels proposed for 2022 (China) or 2023 (Model Regulation). 12 per cent of VSD AC models available in Brazil (as of 2018) are also estimated to meet the level proposed for 2022 (China) or 2023 (Model Regulation).

Market availability, cost, and benefits of equipment are key considerations, among other factors, that must be assessed in the policy-development process. The following context on some key developments may be informative as countries consider where global markets may be headed, but it is not meant to replace the need for a robust assessment of local conditions and the aims of stakeholders in the market.

High-efficiency ACs are already commercially available from a number of major manufacturers, including those using conventional (R-410A) or lower-GWP refrigerants (e.g., R-32, R-290). ACs that surpass the highest efficiency levels recognized by existing labelling programs are available in most regions (Park, Shah, and Gerke 2017); see Figure 5 and Table 7. The average efficiency of ACs in new sales in China is still as much as 60 per cent less than the efficiency of the best available products (International Energy Agency 2019).

By the end of 2018, Indian manufacturers had already sold more than 600,000 R-290 units. At that time, eight Chinese manufacturers committed to selling 220,000 R-290 units in the domestic market in 2019, and 18 AC production lines in China with annual production capacity of 4.5 million units had been converted to R-290 (Hydrocarbons21 2018). Dealers in Ghana and Grenada are also selling R-290 ACs (GIZ 2019). Approximately 68 million R-32 ACs have been sold as of December 2018 (Daikin 2019). It is expected that, by the time the Model Regulation Guidelines would go into effect in markets that choose to adapt them for use (around 2023, if deemed appropriate by the interested country), market adoption of such products will be much higher if current trends are indicative of future growth.

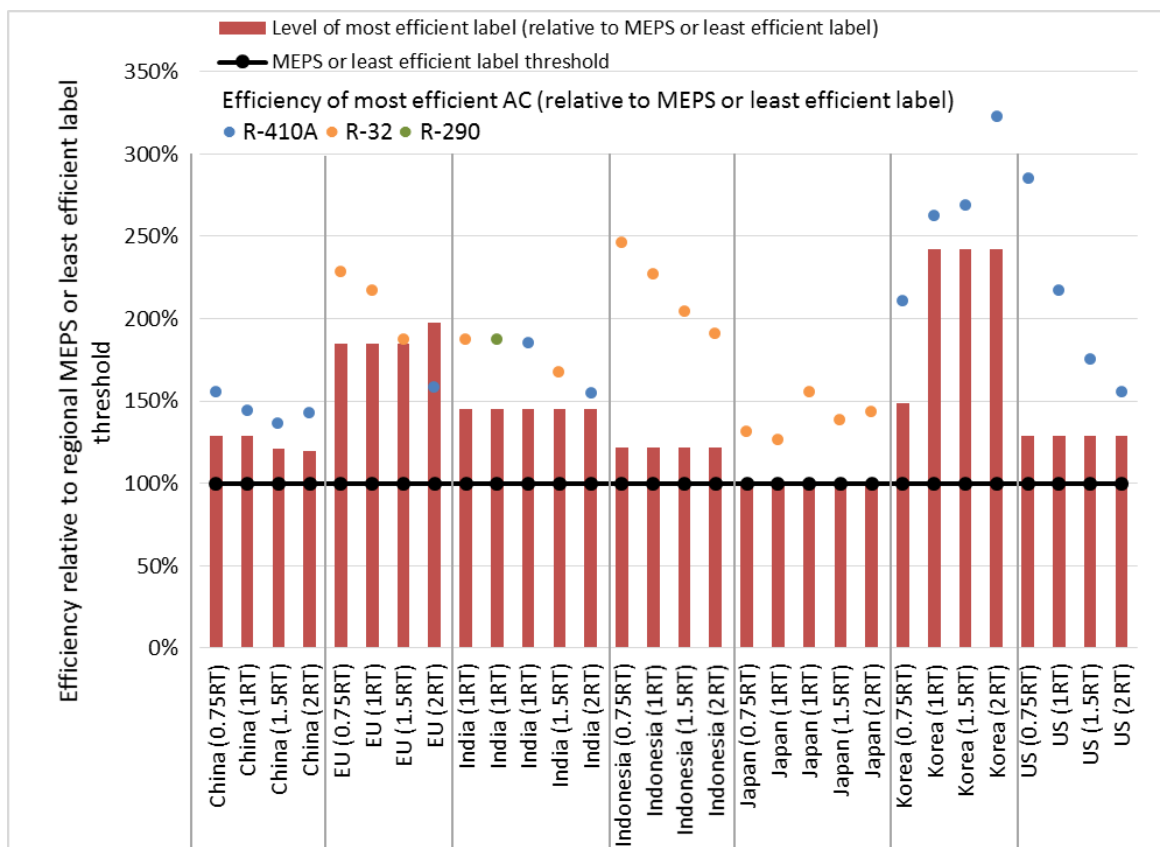

Figure 5: Efficiency of most-efficient models relative to MEPS or least-efficient labels

Source: updated from Park, Shah, and Gerke (2017); see Table 7 for details.

Table 7: Highest-efficiency ACs in selected economies

Region	CC	Metric	MEPS or Least Stringent Label	Most Efficient Label	Efficiency of Best Available Product
	RT (nominal)		Wh/Wh		
China	0.75	China APF	3.50	4.50	5.45
	1.0		3.50	4.50	5.05
	1.5		3.30	4.00	4.50
	2.0		3.10	3.70	4.40
EU	0.75	EU SEER	4.60	8.50	10.5
	1.0		4.60	8.50	10.0
	1.5		4.60	8.50	8.60
	2.0		4.30	8.50	6.80
India	1.0	ISEER	3.10	4.50	6.15
	1.0		3.10	4.50	5.80
	1.5		3.10	4.50	5.60

	2.0		3.10	4.50	5.40
Indonesia	0.75	Indonesia EER	2.64	3.05	6.16
	1.0		2.64	3.05	5.68
	1.5		2.64	3.05	4.95
	2.0		2.64	3.05	4.32
Japan	0.75	Japan APF	6.60	6.60	7.60
	1.0		6.00	6.00	7.60
	1.5		4.90	4.90	6.80
	2.0		4.40	4.40	6.30
Republic of Korea	0.75	Korea CSPF	3.5	6.36	7.10
	1.0		3.5	6.36	7.80
	1.5		3.15	8.20	8.00
	2.0		3.15	8.20	9.60
U.S.	0.75	US SEER	4.10	5.27	12.30
	1.0		4.10	5.27	8.90
	1.5		4.10	5.27	7.20
	2.0		4.10	5.27	6.40

Source: updated from Park, Shah, and Gerke (2017)

Note: 1 RT = 3.5 kW.

As shown in Figure 6, the high efficiency levels in the Model Regulation Guidelines are approximately 30–60 per cent more efficient than the low efficiency levels, and they are comparable with high efficiency levels in regional standards or the efficiency levels of best available technologies (BAT).

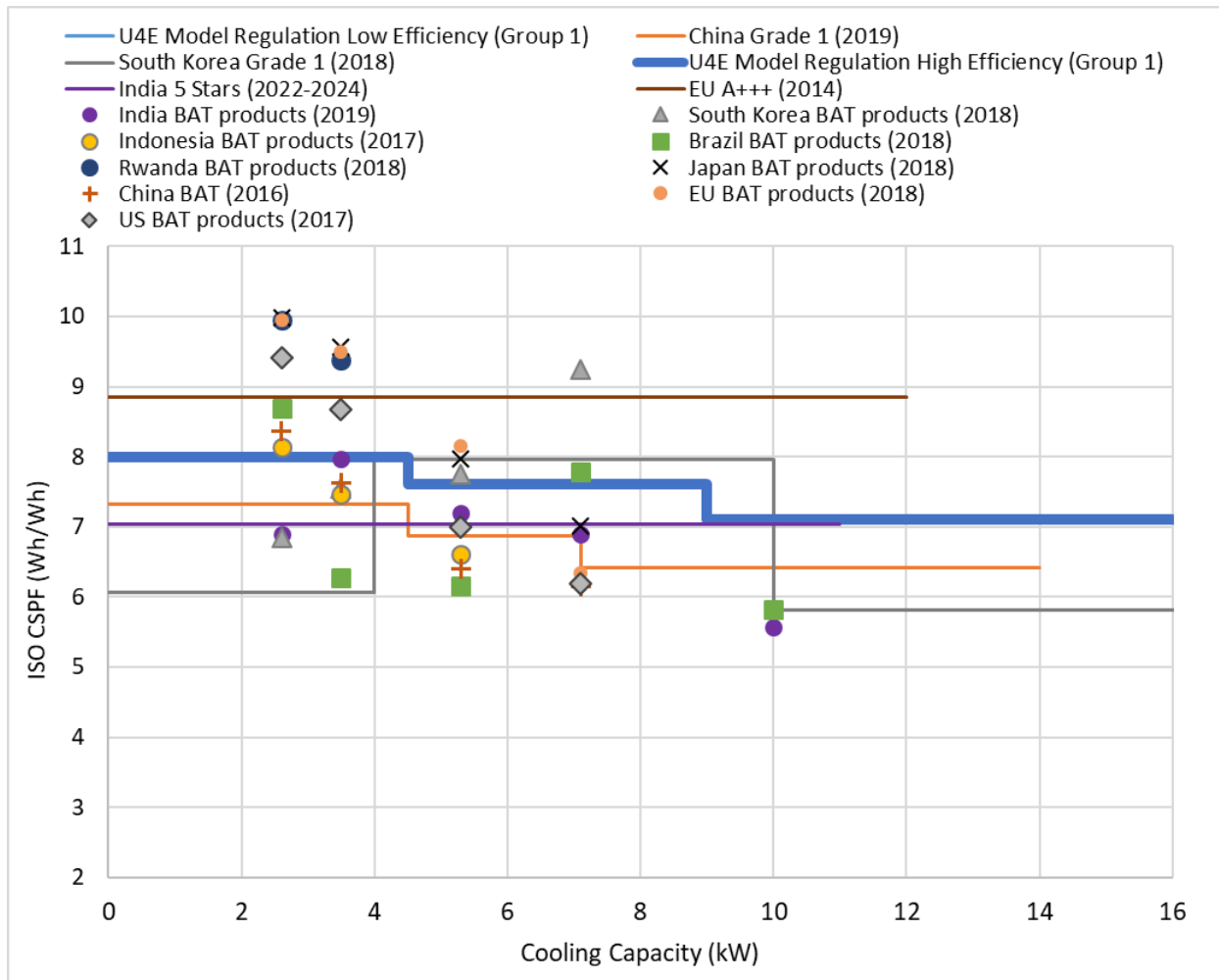

Figure 6: Comparison of high and low efficiency grades of the Model Regulation Guidelines, regional standards, and BAT

Source: LBNL analysis

5. Developing Outdoor Temperature Bin Hours for AC Use

To adopt a seasonal AC energy-efficiency metric as a national standard, a country can use the ISO CSPF metric in accordance with ISO 16358-1:2013, based on the ISO 16358 reference temperature bin hours or country/region climate-specific temperature bin hours such as those in the Model Regulation. For example, Brazil has a hot and humid climate that varies by region from extremely hot-humid (0A) to warm-humid (3A) in terms of American Society of Heating, Refrigerating and Air-Conditioning Engineers (ASHRAE) climate zone definitions, which are based on a cooling degree-day base 10°C (CDD10), heating degree-day base 18°C (HDD18), annual precipitation, annual mean temperature, and so forth.

Figure 7 shows the average annual temperature bin distributions of hot/warm climate regions according to the ASHRAE climate zone definitions. Based on the climate data, hours at 21°C or greater account for 85 per cent of the annual outdoor temperature distributions in select 0A and

1A climate regions, while hours over 35°C account for less than 2 per cent. Figure 8 shows outdoor temperature bin hours assumed for AC use in 0A climate regions. More details on developing outdoor temperature bins for AC use are available in Park et al. (2019a) and Park and Shah (2019).

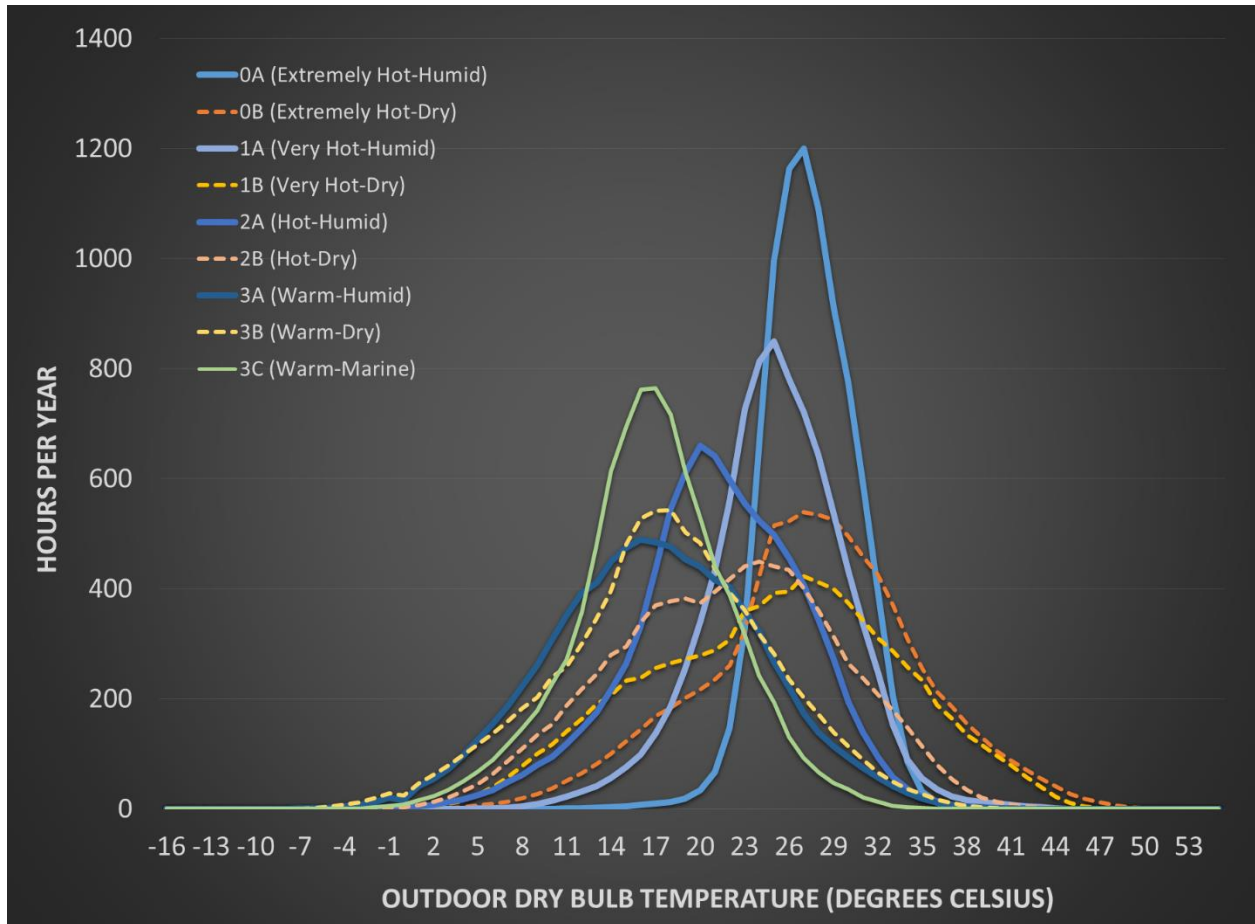

Figure 7: Outdoor temperature distributions of extremely hot to warm climate regions (0A to 3C)

Source: Park and Shah (2019) based on data from 142 weather stations available from ASHRAE weather data viewer 6.0. For illustrative purposes, the original bar charts have been converted into curves.

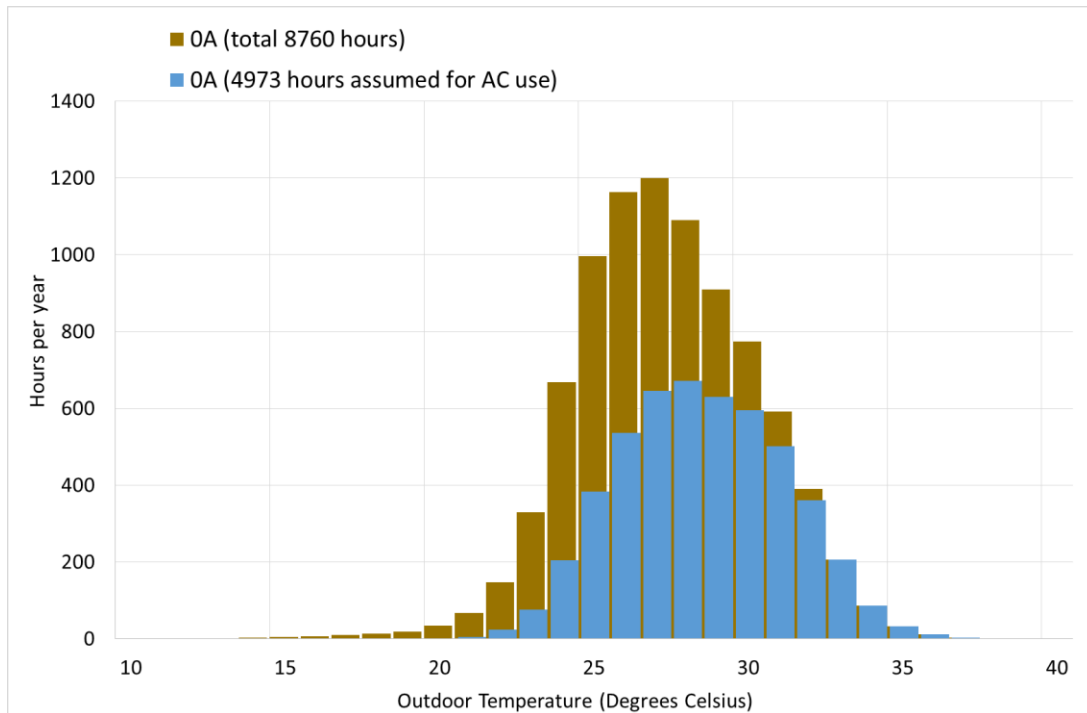

Figure 8: Annual outdoor temperature bin hours (brown) and temperature bin hours assumed for AC use in OA climate regions (blue)

Source: Park and Shah (2019)

6. Rating Performance of ACs in Regional Metrics

Energy-efficiency market-transformation programs for room ACs were initially implemented in the 1990s and early 2000s in many countries. At that time, most countries adopted the EER metric for rating AC performance based on ISO 5151, easily enabling comparison of performance across different markets and globally. However, with the increasing emphasis on rating part-load and seasonal performance in many markets amidst the proliferation of VSD ACs, variations in regional climate make global comparisons of AC efficiencies difficult.

Since the mid-2000s, along with the increasing penetration of VSD ACs, region-specific seasonal energy-efficiency metrics have been designed or adopted to estimate AC performance under regional climatic conditions that affect the amount of time an AC operates at part or full load. These are increasingly used as an alternative to EER or the coefficient of performance (COP) to set S&L requirements for ACs and heat pumps. The regional difference in seasonal efficiency metrics is primarily due to the outside temperature profiles that are used to aggregate steady-state and cyclic ratings into a seasonal efficiency value, as well as the ways of evaluating performance at part-load operation in the metric. Because the seasonal energy efficiency of a commercially available AC is reported in region- and climate-specific metrics, it must be appropriately translated to other regions based on different energy performance due to differences across regions in efficiency metrics, climate, and operating conditions.

With the selected AC models, the ISO CSPF calculation conducted for the Model Regulation Guidelines development refers to ISO 16358-1:2013 Clause 6.4 for fixed-speed units and Clause 6.7 for variable-speed units. The CSPF calculation for variable-speed units is based on two sets of test data—measurement of performance (capacity and power input) at full- and half-capacity operation at an outdoor dry bulb temperature of 35°C—and then performance at 29°C is calculated by ISO 16358-determined equations.

The CSPF calculation for fixed-speed units is based on one set of test data—measurement of performance (capacity and power input) at full-capacity operation at an outdoor dry bulb temperature of 35°C—and then performance at 29°C is calculated by the predetermined equations. The analysis also calculates China standard (GB 21455-2013) defined metrics (SEER for cooling-only products and APF for heat pumps) with the temperature bin hours in the standard. In addition, the analysis establishes regression relationships between the seasonal efficiency metrics (e.g., China SEER vs. ISO CSPF). Figure 9 shows the relationships between China APF and ISO APF based on the climate region 2A temperature bin hours. More details on developing the outdoor temperature bins for AC use are available in Park and Shah (2019) and Park et al. (2019b).

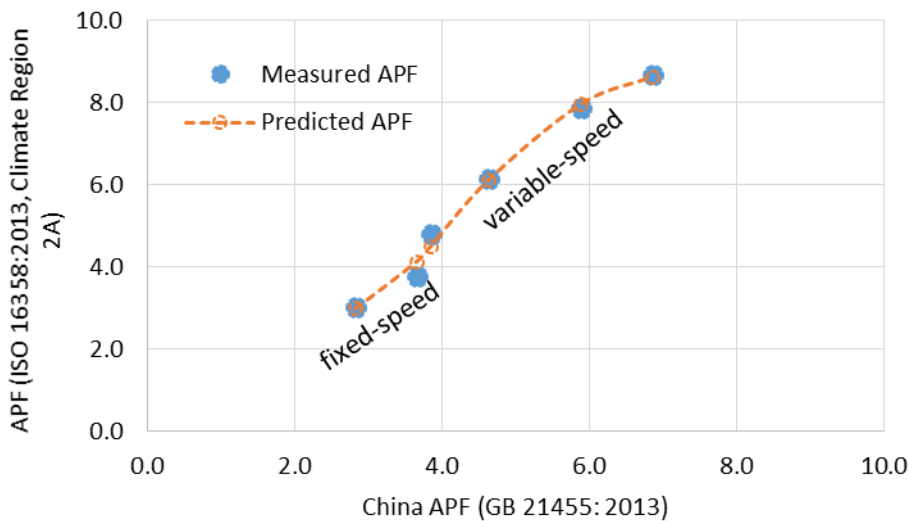

Figure 9: Relationship between China APF (from GB 21455-2013) and ISO APF with 2A temperature bin hours

Source: Park and Shah (2019)

Table 8 summarizes basic specifications of the three AC models analysed. Sample 1 represents current MEPS in many developing economies. Sample 2 meets the Model Regulation Guidelines low-efficiency requirement but not the refrigerant GWP requirement. Sample 3 meets both the Model Regulation Guidelines high-efficiency and refrigerant requirements.

For fixed-speed units, there is no significant difference between the EER and CSPF values. Given that predetermined equations are used to estimate the performance at 29°C, the CSPF for fixed-speed units results in a linear relationship with the EER, i.e., $CSPF = \alpha \times EER$ (e.g., $\alpha = 1.062$ with

the ISO reference temperature bin hours). Considering the annual energy consumption of the three AC models according to the ISO 16358 methods, the high-efficiency product (Sample 3) is estimated to consume 60 per cent less than the baseline fixed-speed unit (Sample 1).

Table 8: Summary of specifications of three AC models

Sample	1	2	3
Compressor type	Fixed speed	Variable speed	
Nominal CC (kW)	3.5–3.6		
EER (W/W)	3.20	3.94	5.02
ISO CSPF (Wh/Wh)	3.40	6.73	9.02
Model Regulation minimum efficiency requirement (Group 1)	6.10		
Model Regulation high efficiency requirement (Group 1)	8.00		
Annual energy consumption based on the ISO 16358 reference temperature bin (kWh)	777	374	307

The total equivalent warming impact (TEWI) is a measure of the global warming impact of equipment based on the total emissions of GHGs during the operation of the equipment and the disposal of the operating fluids at the end-of-life (EOL), taking into account both direct emissions and indirect emissions produced through the energy consumed in operating the equipment (Australian Institute of Refrigeration, Air Conditioning and Heating [AIRAH] 2012).⁵ Figure 10 shows the TEWI calculation results of the three AC samples with the ISO 16358 reference use (1,817 hours). The calculation shows significant GHG emissions savings potential, such as a 58 per cent reduction between Sample 3 (R-32 variable-speed unit) and Sample 1 (R-410A fixed-speed unit). Indirect emissions account for 58–74 per cent of total emissions from these examples, varying by assumptions.

⁵ The methodology for calculating TEWI is as follows:

$$\text{TEWI} = \text{GWP (direct; refrigerant leaks including EOL)} + \text{GWP (indirect; operation)} = (\text{GWP} \times m \times L_{\text{annual}} \times n) + \text{GWP} \times m \times (1 - \alpha_{\text{recovery}}) + (\text{E}_{\text{annual}} \times \beta \times n)$$

Where: GWP = GWP of refrigerant, relative to CO₂ (GWP CO₂ = 1); L_{annual} = leakage rate per year (unit: %); n = system operating life (unit: years); m = refrigerant charge (unit: kg); α_{recovery} = recovery over recycling factor from 0 to 1; E_{annual} = energy consumption per year (unit: kWh per year); β = indirect emission factor (unit: kg CO₂ per kWh).

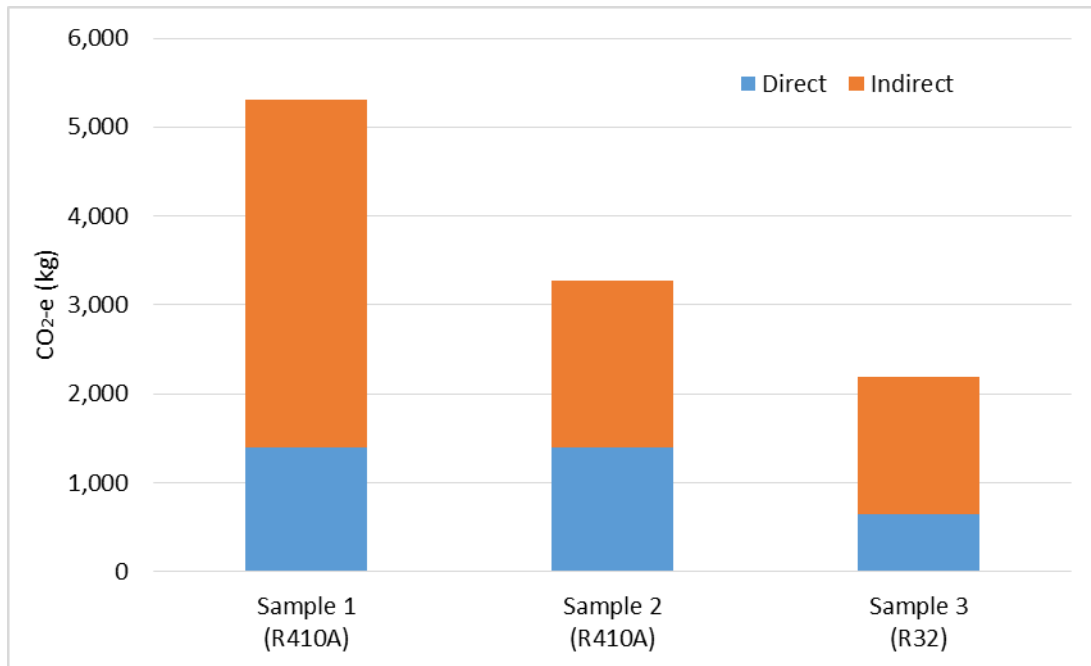

Figure 10: TEWI calculation results for three AC models

CO₂-e = CO₂ equivalent

Assumptions: $L_{\text{annual}} = 4.0$ per cent; $n = 10$ years; $m = 0.95$ kg (Samples 1–2), 1.35 kg (Sample 3); $\alpha_{\text{recovery}} = 0.7$; $\beta = 0.505$ kg CO₂ per kWh, based on AIRAH (2012) and International Energy Agency (2008).

7. Considerations of Product Availability and Cost

One policy concern about higher-efficiency products relates to higher prices. However, several studies have shown that prices in real terms have continued to decline despite major efficiency improvements. This is possible because clear mandates and supporting policies that incentivize efficiency unleash economies of scale that reduce costs (Phadke et al. 2017). Higher energy efficiency is typically a feature of more expensive products. However, highly efficient, cost-competitive ACs are also available. Developing and emerging countries can tap into these economies of scale by pursuing similar policies to those that are helping to drive this global transition.

Figure 11 shows efficiency and price trends for 425 AC models in China and three models in India by product type, refrigerant, and CC. Higher-efficiency products tend to have a wider price range compared with lower-efficiency products, partly because high-efficiency models are often sold as premium products bundled with other features. As efficient AC prices continue to fall and consumer awareness of the implications (e.g., on their utility bills) of efficiency grows, consumers can make more informed decisions while having a wider array of options among products that have a lower cost of ownership (if hours of use remain consistent with hours they would have used with an inefficient AC).

Park et al. (2019c) find that the barriers to improving energy efficiency while transitioning to lower-GWP refrigerants for most ACs are primarily non-technical and could be mitigated by appropriately holistic market-transformation programs that complement S&L with procurement programs, market-based financial mechanisms, and incentives.

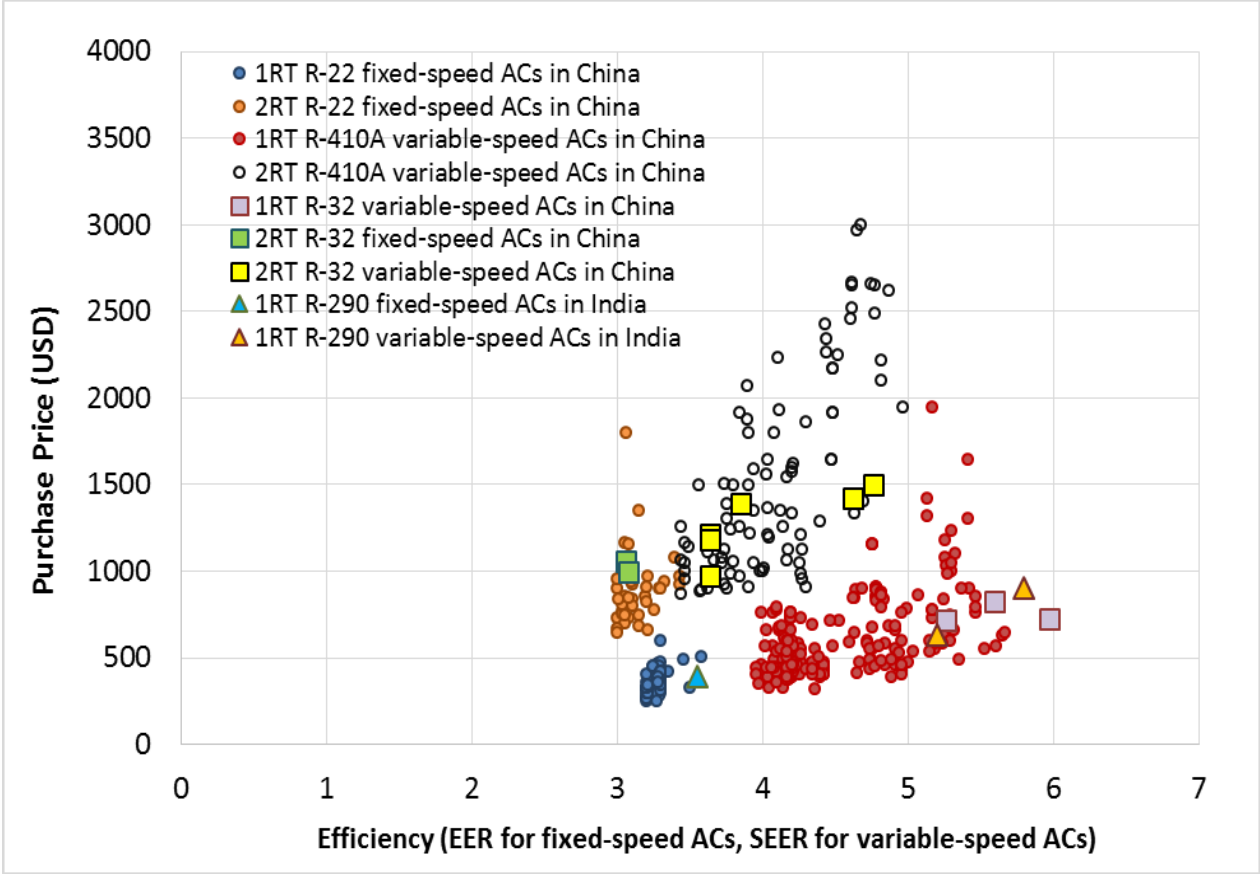

Figure 11: Price vs. efficiency of 1-RT and 2-RT ACs in China and India

Source: Park, Shah, and Gerke (2017)

China is the world’s largest producer and consumer of ACs and contributes about a quarter of global CO₂ emissions due to space cooling. The new China MEPS that will be effective in 2022 are expected to help shift the global market toward energy-efficient technologies. A study finds that the newly proposed MEPS in China would contribute to reducing CO₂ emissions by about 13 per cent between 2019 and 2050 while providing bill savings of 2,620 billion renminbi (RMB)—about 380 billion U.S. dollars (USD)—to China’s consumers (Karali et al. 2019). The study also finds that the highest-efficiency scenario, reaching MEPS APF 5.4 in 2025, provides the largest long-term national benefits.

Phadke et al. (2019) project lifetime AC electricity consumption between 2019 and 2050, emissions savings, and consumer bill savings in China and other developing economies under the high-efficiency scenario (MEPS APF 5.4 in 2025). By setting such a long-term target, China can

help set the global standard for green cooling with a GHG emissions reduction of more than 40 billion tons of CO₂e. Consumers in China and worldwide would save more than 5 trillion USD, leading to better economic performance and higher consumer welfare. Several studies show economic impacts of efficiency improvements in country- or region-specific settings (Letschert et al. 2019; Shah et al. 2016; ECODESIGN Preparatory Study 2009).

8. Charge Size Limitation for Flammable (A3) Refrigerants

Countries (and sometimes regions within countries) have their own processes and timelines for developing refrigerant standards. The International Electrotechnical Commission (IEC) standards for mildly flammable (A2L) and flammable (A3) refrigerants⁶ are currently under revision, and new standards are expected to be available in the next few years. Interested countries can refer to the latest international or regional standards on refrigerant charge limits at the time of policy design or revision. At present, several standards covering use of flammable refrigerants, charge limitation, and related equipment are available in IEC 60335-2-40, ISO 5149, EN 378-1, and so forth (Park et al. 2019c).

For systems installed without restrictions on room size, there is a maximum charge size limit of 150 g for flammable refrigerants (A3) (Park et al. 2019c; LIFE FRONT 2018). If the allowable charge limit for safe use increases to 1 kg, the maximum capacity of mini-split units could reach 7 kW, which would enable room ACs using R-290 to target 80 per cent of the global market (Zeiger, Gschrey, and Schwarz 2014). For small self-contained and split systems, ISO 5149 and IEC 60335-2-40 specify the maximum charge size limit of hydrocarbons (HCs) to be 0.3 kg and 1.0/1.5 kg, respectively, and the allowable charge size to be 0.01 x room volume (m³) and 0.04 x height (m) x room area (m²)^{0.5}, respectively (Table 9). Table 10 shows examples of low-GWP refrigerant alternatives for stationary ACs.

Table 9: Refrigerant charge size limits for HCs safety standards, for ACs and heat pumps

	IEC 60335-2-40		ISO 5149-1	
	Maximum charge	Allowable charge	Maximum charge	Allowable charge
Small self-contained	0.3 kg	$0.01 \times V_{rm}$	0.3 kg	$0.01 \times V_{rm}$
Ductless split	1 kg	$0.04 \times h \times A_{rm}^{0.5}$	1.5 kg	$0.04 \times h \times A_{rm}^{0.5}$

Source: LIFE FRONT (2018)

V_{rm} = room volume (in m³), A_{rm} = room area (in m²), and h = unit installation height (in m)

⁶ Categories are based on ASHRAE 34 safety classification, where A1 is lower toxicity/no flame propagation, A2/A2L is lower toxicity/low flammability, and A3 is lower toxicity/higher flammability.

Table 10: Examples of low-GWP alternatives for stationary ACs

Type	Chemical	Safety Class ^a	GWP ^b	Flammability ^c	Comments
HCFCs	HCFC-22	A1	1,760	1	
HFCs	HFC-410A	A1	1,900	1	
	HFC-134a	A1	1,300	1	
Low-GWP Alternatives					
HFCs	HFC-32	A2L	677	2L	Small self-contained AC systems available. Small split AC systems also available in parts of Asia, India, and Europe.
HFOs	HFO-1234yf	A2L	< 1	2L	Considered for ducted and rooftop units, subject to safety standards and codes.
	HFO-1234ze	A2L	< 1	2L	
HFO/HFC Blends	HFO-1336mzz(Z)	A1	2	1	U.S. EPA Significant New Alternative Policy (SNAP) approved in 2016 for use in industrial process AC (new equipment).
	R-446A	A2L	460	2L	Newly developed blends being developed for small split ACs. Also for multi-splits, VRF systems, and ducted systems subject to safety standards and codes.
	R-447A	A2L	570	2L	
	R-452B	A2L	680	2L	
R-454B	A2L	470	2L		
HFO/HFC Blends	R-450A	A1	550	1	Possible alternatives for ducted and packaged rooftop units.
	R-513A	A1	570	1	
	R-513B	A1	540	1	
HCs	HC-290	A3	3	3	Limited availability for small split ACs in Europe and parts of Asia owing to flammability concerns.
	HC-1270	A3	2	3	
Ammonia	R-717	B2L	0	1	Used only for chillers with small capacities owing to costs.
Water (H ₂ O)	R-718	A1	N/A	1	Limited to special applications for chillers.
CO ₂	R-744	A1	1	1	Limited applicability for stationary AC systems and chillers based on reduced efficiency in high ambient temperatures. Market may not support development cost of components.

HFO = hydrofluoroolefin

^a ASHRAE 34 safety classification where A1 is lower toxicity/no flame propagation, A2/A2L is lower toxicity/low flammability, A3 is lower toxicity/higher flammability, B1 is higher toxicity/no flame propagation, B2/B2L is higher toxicity/low flammability, and B3 is higher toxicity/higher flammability.

^b 100-year time horizon GWP relative to CO₂ in accordance with the Fifth Assessment Report (AR5) of the Intergovernmental Panel on Climate Change (IPCC).

^c Refrigerant flammability classified based on ASHRAE 34 where 1 is no flame propagation, 2L is lower flammability, 2 is flammable, and 3 is higher flammability.

Source: Park, Shah, and Gerke (2017)

References

- Australian Institute of Refrigeration, Air Conditioning and Heating (2012). *Methods of Calculating Total Equivalent Warming Impact (TEWI) 2012*.
https://www.airah.org.au/Content_Files/BestPracticeGuides/Best_Practice_Tewi_June2012.pdf.
- ChinaIOL (2018). *Progress Report on 2018 China Room AC Energy Efficiency Survey by ChinaIOL*.
- China National Institute of Standardization (2019). *Letter of Solicitation of Comments on the National Standards for Energy Efficiency Limits and Energy Efficiency Ratings for Room Air Conditioner*.
- Daikin (2019). R-32: The Most Balanced Refrigerant for Stationary Air Conditioners and Heat Pumps. <https://www.daikin.com/csr/information/influence/hfc32.html>. Accessed 9 August 2019.
- ECODESIGN Preparatory Study (2009). *Preparatory Study on the Environmental Performance of Residential Room Conditioning Appliances (Airco and Ventilation): Improvement Potential*.
https://www.eup-network.de/fileadmin/user_upload/Produktgruppen/Aircon_Final_report_of_Task_7.pdf.
- GIZ (2018). *International Safety Standards in Air Conditioning, Refrigeration & Heat Pump*. Eschborn. https://www.international-climate-initiative.com/fileadmin/Dokumente/2018/180712_Safety_Standards.pdf.
- Hydrocarbons21 (2018). 8 Major Chinese RAC Makers Commit to Selling 220k R290 Units in 2019. 4 December.
http://hydrocarbons21.com/articles/8713/8_major_chinese_rac_makers_commit_to_sell_220k_r290_units_in_2019. Accessed 9 August 2019.
- International Energy Agency (2019). *The Future of Cooling in China – Delivering on Action Plans for Sustainable Air Conditioning*.
<https://www.iea.org/publications/reports/TheFutureofCoolinginChina/>.
- International Energy Agency (2008). *CO₂ Emissions from Fuel Combustion*. https://www.oecd-ilibrary.org/energy/co2-emissions-from-fuel-combustion-2008_co2_fuel-2008-en-fr.
- Japan Refrigeration and Air Conditioning Industry Association (2018a). *World Air Conditioner Demand by Region*. https://www.jraia.or.jp/english/World_AC_Demand.pdf.
- Japan Refrigeration and Air Conditioning Industry Association (2018b). *World Air Conditioner Demand by Region and Technology*.
https://www.jraia.or.jp/english/World_AC_Demand_inverter.pdf.
- Karali, N., Shah, N., Park, W., Khanna, N., Ding, C., Lin, J., and Zhou, N. (2019). *Improving the Energy Efficiency of Room Air Conditioners in China: Costs and Benefits*. Draft analysis. Lawrence Berkeley National Laboratory.
- Kigali Cooling Efficiency Program (2019). Comment from an Industrial Participant at the International Conference – Perspectives for Energy Efficiency Improvement in the Brazilian Air Conditioners' Market.

- Letschert, V., Karali, N., Park, W., Shah, N., Jannuzzi, G., Costa, F., Lamberts, R., and Borges, K. (2019). *The Manufacturer Economics and National Benefits of Cooling Efficiency for Air Conditioners in Brazil*. ECEEE 2019 Summer Study. Belambra Presqu'île de Giens, France, 3–8 June 2019. European Council for an Energy Efficient Economy. <https://ies.lbl.gov/publications/manufacturer-economics-and-national>.
- LIFE FRONT (2018). *Impact of Standards on Hydrocarbon Refrigerants in Europe: LIFE FRONT (Flammable Refrigerants Options for Natural Technologies)*. <http://lifefront.eu/wp-content/uploads/2018/10/impact-of-standards-om-hydrocarbon-refrigerants-in-europe-life-front-report.pdf>.
- Park, W., Shah, N., and Gerke, B. (2017). *Assessment of Commercially Available Energy-Efficient Room Air Conditioners Including Models with Low Global Warming Potential (GWP) Refrigerants*. https://eta.lbl.gov/sites/default/files/publications/assessment_of_racs_lbnl_2001047.pdf.
- Park, W. (2019). *Regional Policy Alignment: Model Energy & Refrigerant Regulations for Air Conditioners*. Presented at the International Conference – Perspectives for Energy Efficiency Improvement in the Brazilian Air Conditioners' Market. Auditório Eletrobrás, Rua Conselheiro Saraiva, n.41, Centro, Rio de Janeiro. March 25, 2019.
- Park, W., and Shah, N. (2019). *Adopting a Seasonal Efficiency Metric for Room Air Conditioners - Part 1: Cooling Efficiency*. Draft analysis. Lawrence Berkeley National Laboratory.
- Park, W., Shah, N., Letschert, V., and Lamberts, R. (2019a). *Adopting a Seasonal Efficiency Metric for Room Air Conditioners: A Case Study in Brazil*. Lawrence Berkeley National Laboratory.
- Park, W., Phadke, A., Shah, N., Choi, J., Kang, H., and Kim, D. (2019b). *Lost in Translation: Overcoming Divergent Seasonal Performance Metrics to Strengthen Policy for Air Conditioner Energy Efficiency*. Draft analysis. Lawrence Berkeley National Laboratory.
- Park, W., Shah, N., Ding, B.C., and Qu, Y. (2019c). *Challenges and Recommended Policies for Simultaneous Global Implementation of Low-GWP Refrigerants and High Efficiency in Room Air Conditioners*. <https://escholarship.org/uc/item/07j5f74s>.
- Phadke, A., Shah, N., Lin, J., Park, W., Zhange, Y., Zaelke, D., Ding, C., and Karali, N. (2019). *Chinese Policy Leadership Would Cool Global Air Conditioning Impacts*. Berkeley, CA: Lawrence Berkeley National Laboratory.
- Phadke, A., Park, W., Abhyankar, N., and Shah N. (2017). *Relationship between Appliance Prices and Energy-Efficiency Standards and Labeling Policies: Empirical Evidence from Residential Air Conditioners*. *9th International Conference on Energy Efficiency in Domestic Appliances and Lighting (EEDAL)*. Irvine, USA, 13-15 September 2017. California Plug Load Research Center. <http://eedal2017.uci.edu/wp-content/uploads/Thursday-14-Abhyankar-1.pdf>.
- Shah, N., Abhyankar, N., Park, W., Phadke, A., Diddi, S., Ahuja, D., Mukherjee, P.K., and Walia, A. (2016). *Cost-Benefit of Improving the Efficiency of Room Air Conditioners (Inverter and Fixed Speed) in India*. <https://ies.lbl.gov/publications/cost-benefit-improving-efficiency>.

Technical Committee Meeting (2019). *Minutes of Meeting. 11th Technical Committee Meeting for Room Air Conditioners.*

<http://www.beestarlabel.com/Home/ViewMinutesMeeting?EqpID=1>.

United Nations Development Programme (2019). *Market Assessment of Residential and Small Commercial Air Conditioners in South Africa.* Final draft.

Zeiger, B., Gschrey, B., and Schwarz, W. (2014). *Alternatives to HCFCs/HFCs in Unitary Air Conditioning Equipment at High Ambient Temperatures.* Frankfurt.

https://ec.europa.eu/clima/sites/clima/files/f-gas/legislation/docs/alternatives_high_gwp_annex_en.pdf.

