



ERNEST ORLANDO LAWRENCE BERKELEY NATIONAL LABORATORY

Methods for Detailed Energy Data Collection of Miscellaneous and Electronic Loads in a Commercial Office Building

Steven Lanzisera^a,
Stephen Dawson-Haggerty^b, H.Y. Iris Cheung^a,
Jay Taneja^b, David Culler^b, Richard Brown^a

^a Lawrence Berkeley National Laboratory
1 Cyclotron Rd, Berkeley, CA 94720 USA

^b University of California, Berkeley
Berkeley, CA 94720 USA

Environmental Energy Technologies Division

April 2013

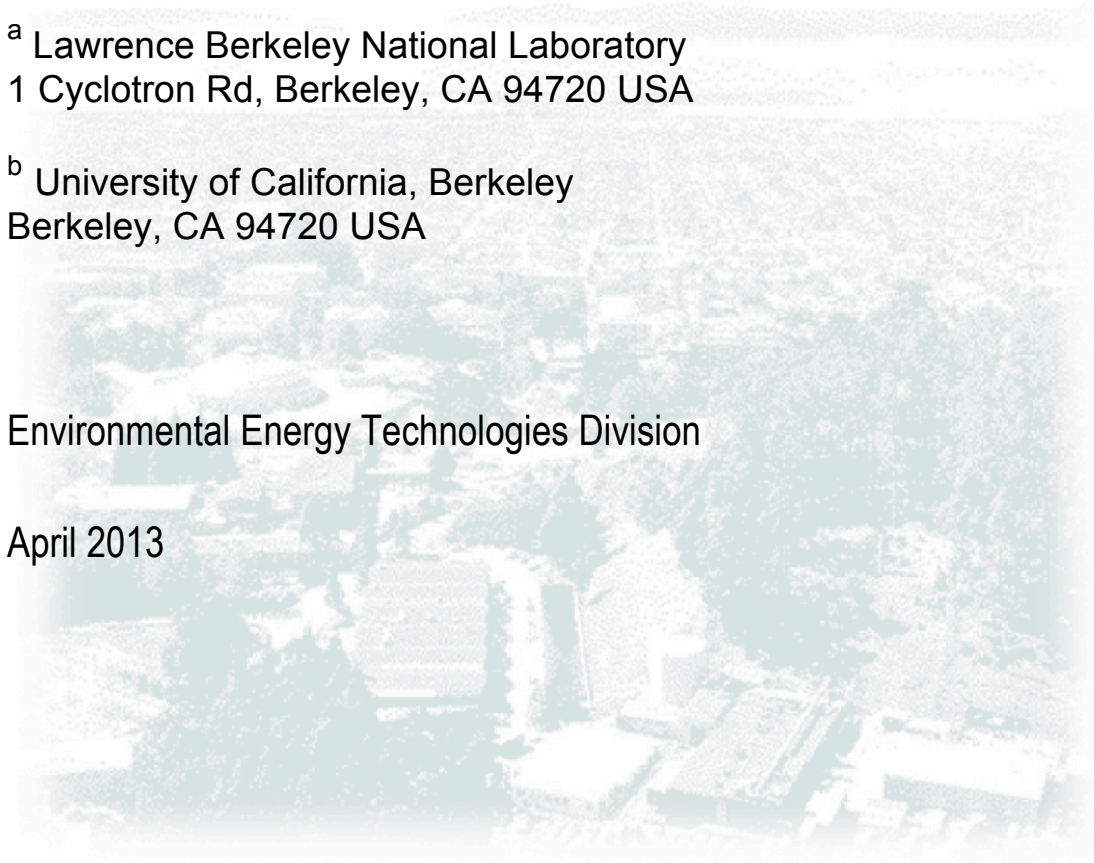

DISCLAIMER

This document was prepared as an account of work sponsored by the United States Government. While this document is believed to contain correct information, neither the United States Government nor any agency thereof, nor The Regents of the University of California, nor any of their employees, makes any warranty, express or implied, or assumes any legal responsibility for the accuracy, completeness, or usefulness of any information, apparatus, product, or process disclosed, or represents that its use would not infringe privately owned rights. Reference herein to any specific commercial product, process, or service by its trade name, trademark, manufacturer, or otherwise, does not necessarily constitute or imply its endorsement, recommendation, or favoring by the United States Government or any agency thereof, or The Regents of the University of California. The views and opinions of authors expressed herein do not necessarily state or reflect those of the United States Government or any agency thereof or The Regents of the University of California.

Acknowledgment

This work was supported by the Assistant Secretary for Energy Efficiency and Renewable Energy, Building Technologies Program, of the U.S. Department of Energy under Contract No. DE-AC02-05CH11231.

Methods for Detailed Energy Data Collection of Miscellaneous and Electronic Loads in a Commercial Office Building

ABSTRACT

Miscellaneous and electronic loads (MELs) consume about 20% of the primary energy used in U.S. buildings, and this share is projected to increase for the foreseeable future. Our understanding, however, of which devices are most responsible for this energy use is still rudimentary due to the difficulty and expense of performing detailed studies on MELs and their energy use. In order to better understand the energy use of MELs and the design of MELs field metering studies, we conducted a year-long study of MELs in an 89,500 sq. ft. (8310 m²) office building.

We present insights obtained from this study using 455 wireless plug-load power meters including the study design process, the tools needed for success, and key other methodology issues. Our study allowed us to quantify, for the study buildings, how many devices we needed to inventory and meter as well as for how long we needed to collect meter data. We find that the study design of earlier work would not have yielded accurate results in our study building. This paper presents these findings along with a brief summary of the energy related results, and it highlights areas where common study design decisions would not have yielded satisfactory results.

1. Introduction

Buildings account for 40% of the total primary energy consumption in the U.S., with 22% consumed by the residential sector and 18% by the commercial sector. Figure 1 shows how the

primary energy use is broken down by end-use in the U.S [1]¹. About 20% of the primary energy is consumed by a category we labeled miscellaneous and electronic loads (MELs), and the energy use of these devices is projected to grow to one-third of the primary energy used in U.S. buildings in the next 20 years [2]. MELs energy use is spread among many devices and product categories but primarily comes from plug-loads in many buildings. However, MELs often include elevators and medical, cooking, and refrigeration equipment [3]. As a result, the devices that dominant MELs energy use changes depending on the function of the building. Plug-loads are particularly challenging to address because of their large number, diversity, and transient nature, and we estimate this category is responsible for 15% of U.S. building primary energy use. Developing and evaluating efficiency strategies for these products depends on understanding their prevalence, varied usage patterns, and energy use information. Few studies have collected field data on the long-term energy use of individual plug-load devices due to the difficulty and expense of such a study.

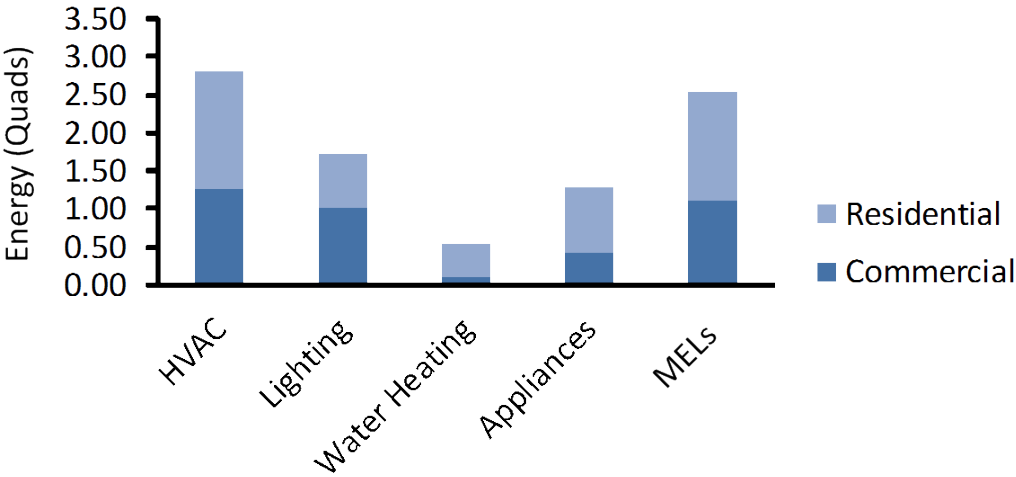

Figure 1. Breakdown by End-use of U.S. Annual Energy Use

¹ Figures taken from AEO with the “other” category reduced to remove local generation. MELs include process loads like appliances and cooking equipment.

In this paper we present results and insights from a study of the plug-loads and their energy use in an 89,500 square-foot (8310 m²) office building. We tested techniques for inventorying plug-loads in buildings and performed a full inventory of the plug-loads in the building. We then deployed custom wireless power meters on a random sample of 455 plug-loads for 6 to 16 months. We based our study and sampling weights on past experience or other studies where possible, but it was clear that there is no good basis for determining sample weights, sample size and many other questions related to study design.

This study was designed to look at the methodology for collecting accurate energy information on annual energy use, usage patterns, and energy savings opportunities of representative plug-loads in a typical office building. Specifically, we addressed the following important methodological questions: 1) What tools are required to effectively evaluate plug-loads energy use, 2) How much of the building floor area should be inventoried, 3) What fraction of the inventoried devices should be metered, 4) How long should these devices be metered, and 5) At what sampling intervals should power data be collected?

Addressing these methodological questions will help inform future plug-loads energy measurement studies by providing some basis for setting study parameters, but it is important to keep in mind that this single building may not be representative of all of the diversity present in office buildings. This paper provides a summary of related work, the tools developed to enable this study, a brief overview of inventory and energy results, and our attempts to answer to the methodological questions discussed in this introduction.

2. Related Research on MELs Energy Use

There have been several studies on MELs energy use in recent years, and these studies have increased our level of knowledge. This section provides an overview of basic study methods and the limitations of these methods.

Building energy surveys provide a comprehensive, top-down study of building energy use and can include a breakdown of some MELs energy use. For example the Commercial Energy Consumption Survey (CBECS) characterizes U.S. commercial building energy use [4], and it uses a survey of building owners to collect building details on size, function, schedule, and a few other categories. This information is combined with weather data and annual energy use by fuel type in a statistical regression model to estimate end-use breakdowns of energy use. The method is not based on actual inventory of devices or metering in the buildings and is therefore subject to errors due to data accuracy or model specification in both the traditional end-uses and in the MELs case. The traditional end-uses of heating, cooling, lighting, and water heating, however, tend to be modeled better because the regression model outputs can be compared to extensive field study results and physics-based simulation of building energy use. This leaves MELs as more or less residuals with large estimation errors. Building energy surveys tend to provide the broadest picture of building energy use, however.

Another study approach that provides a deeper look at MELs energy use is to combine power-consumption data with activity patterns and stock data to produce bottom-up estimates of MELs energy use by device type. Power data and activity patterns can be taken from controlled, laboratory studies with assumed activity profiles or from existing field study data if it is available. Such a study for the commercial sector in the U.S was presented in [3]. While the engineering approach provides a detailed energy estimate for each product category, data for shipment, stock,

device power consumption, and usage patterns are subject to different, and often large, levels of uncertainty. This study type provides more detail in the area of study than standard building surveys, and it is a critical component of understanding the energy use of MELs.

Branch-circuit metering in individual buildings can be used to identify large individual loads (e.g. furnaces) or aggregates for a large number of smaller loads. Circuit level metering is expensive to install, and this limits studies to a relatively small number of circuits. Most circuits containing MELs contain not only a large number of individual devices but also a significant diversity in device type. While these studies are an important basis for our knowledge of energy use in buildings, they are best at identifying the consumption of large devices such as furnaces, water heaters, and refrigerators, and in determining the energy shares of major end uses. The study in [13] used this method to evaluate the fraction of building energy use that is plug loads and the savings available through smart plug strips.

Non-Intrusive Load Monitoring (NILM) collects data at the circuit breaker or whole building level and uses algorithms to disaggregate loads by recognizing energy use signatures of specific devices and reporting their power draw and operation time. NILM has been studied since the 1980s but MELs studies have not relied upon this technology due to its inability to measure more than a few large appliances. The challenges of using NILM on MELs lie in that the relatively small power draw of MELs tend to be obscured with fluctuations aggregated power profile. There are a significant number of companies currently developing and deploying NILM technologies, and it is possible NILM will be useful for MELs studies in the near future.

Device level metering is considered the best method of collecting MELs energy data today. In the US, MELs metering has been conducted in both residential [5] and commercial [6] buildings in California, and also for residential buildings in Minnesota [7]. The commercial building study

in [6] evaluated devices in 25 small office buildings and collected two weeks of 1-minute power data on 430 total devices, and it was the first study to measure plug-loads in an office environment. Devices were not randomly selected limiting the ability to make comparisons across similar devices. The data collected through these studies significantly improved the state of knowledge of MELs energy use in U.S. buildings. The main limitations are that the expense of the metering equipment limits the number of devices per building that can be metered and the limited on-board data storage limits the number of data points that can be collected. The storage limit results in the product of the samples taken per hour and the metering period in hours being a fixed value for a particular meter, and sample rate and metering period can be traded off depending on study needs. These studies have not shown, however, how long devices should be metered to accurately estimate annual energy use or how often the power should be recorded. Studies have also not reported on how many devices should be metered to accurately estimate device energy use and variability in energy use or how to reduce labor associated with device inventory data collection.

3. Design of a Device-Level, Plug-Load Metering Study

Metering individual devices provides high quality data on the energy use of those devices, but it is challenging to design a study that answers the energy questions of interest. Key questions this type of study should answer include:

- What types and quantities of devices are present?
- How much time and at what power level do devices spend in particular power modes?
- How much energy do the devices use annually?
- What load shapes occur?

- How much variability exists in power levels, usage patterns, and energy use between devices?

This list is not exhaustive, but it shows that questions commonly involve both non-energy and energy data, and the energy data should include time-series power measurements. This section describes the high-level design of the study discussed in this paper including some basic tradeoffs in these decisions.

We selected a commercial office building for this study that was conveniently located, moderate in size, to which we could acquire broad access permissions, and which appeared to be typical based on our experience in office buildings. The commercial study building is a 1960s era facility largely used as a traditional office space. It has a total floor area of 89,500 square feet. Approximately 450 occupants in six working groups are located on four floors and a basement.

In order to identify the types and number of devices in the building, we needed to carry out either a complete or partial inventory of devices at the site. A partial inventory, one that only covers a subset of the building's floor area, can be projected to the entire building by taking average device densities found in the inventory and multiplying by the number of rooms or amount of space in the full building. In a partial inventory, researchers must determine how much floor area and what types of spaces to inventory to reasonably estimate the devices present in the building.

We carried out a complete inventory of the plug-loads in the building in order to have ground truth to estimate how much of the building needed to be inventoried for a reasonable whole building estimate.

With the large number of MELs found in our study building, metering all of the devices would be time- and cost-prohibitive. With constraint of resources for about 450 metered devices,

we developed a multi-stage, stratified random sampling approach to select devices for metering. Devices were divided into stages by physical location or organization owning the devices in order to ease coordination with workgroups. For each stage, devices were selected for metering using a stratified sample by device. A stratified sample is critical because a simple random sample would result in metering a large number of devices with low energy use or low energy use variability (e.g. computer speakers, external disk drives) while also not metering as many devices with more energy use and variability such as computers or LCD displays. We set our sample weights based on the number of meters we had available and the proportion of devices for each device category we thought we would need to minimize the total annual energy estimation confidence interval for the population of plug loads in the building. It was not possible to analytically evaluate this second goal before deployment because there were no data available on the variability in energy use between devices of the same category. Instead considered the unit energy consumptions (UECs, the average annual energy use for single unit of a particular device type) taken from earlier data collections and variability estimates based on our experience for different device categories and developed sampling weights. Devices expected to use more energy on an individual basis had higher sample weights, and devices with greater inter-device variability also had greater sample weights. For example, task lights are not expected to use much energy on average (because many are never turned on at all), but their variability in usage is high. As a result, they were sampled with a moderate sample weight (5%). We expected to see high energy use and variability in computers, computer displays, and small imaging equipment, so they were assigned high sample weights (15%). Computer speakers and electric staplers were assigned low sample weights (2.5%). Some devices, like appliances, water coolers and large imaging equipment (e.g., multifunction printer copy machines), are few in

number but can contribute significantly to energy use, and we sampled these devices at the highest sample rate (40%).

In order to collect data for a long period of time at a relatively high sample rate, we decided data should be collected over a network to break away from constraints of internal storage and reduce the labor needed to download meter data on a regular basis. After reviewing network enabled plug-load meters, we selected a wireless metering system under development by the University of California, Berkeley. After updating and modifying the metering system for this study, we deployed our meters for 6 to 16 months and collected an average power measurement every 10s.

4. Inventory and Energy Results

We completed a full device inventory and metered a random sample of devices for a longer time period than in related studies. A total of 80 hours (160 person hours) were spent performing the inventory showing that a full inventory is a significant cost for studying plug load devices. We deployed a total of 455 meters on selected devices. The deployment took approximately 120 person-hours which involved about an equal amount of time obtaining written consent from individual occupants and physically installing the meters. Time-series energy data were collected in the commercial building from 6 to 16 months, as we deployed the meters in a few stages but uninstalled them all at once.

We were able to project from our sample of metered devices to the building population energy use as well as compare power, activity and energy information between similar devices. Figure 2 presents the whole building inventory count as well as annual energy consumption of devices in the top seven energy-consuming categories and all other metered devices for the study building, and Table 1 presents these values numerically. The energy estimates for the entire

population are projected from the metered sample of devices using the sample weights, and energy is projected from the metering period to the entire year. Computers use the most energy overall (about half of the plug-load energy) and significantly more energy per unit than most other categories, whereas the “Other” category of devices shows the opposite behavior. Because the building is primarily office space, displays, imaging and network equipment (e.g., network switches and routers), and miscellaneous (i.e. task) lighting are the next largest MEL energy users. Space heaters and fans make up most of miscellaneous HVAC, and the appliances are primarily refrigerators found in break rooms and a few offices. The energy breakdown shows that information technology equipment consumes over 75% of the annual MELs energy but is less than half of the total devices. This suggests that targeted plug load efficiency strategies that reduce IT energy will have the largest opportunity for impact in an office building, and this conclusion agrees with other sources [1,3].

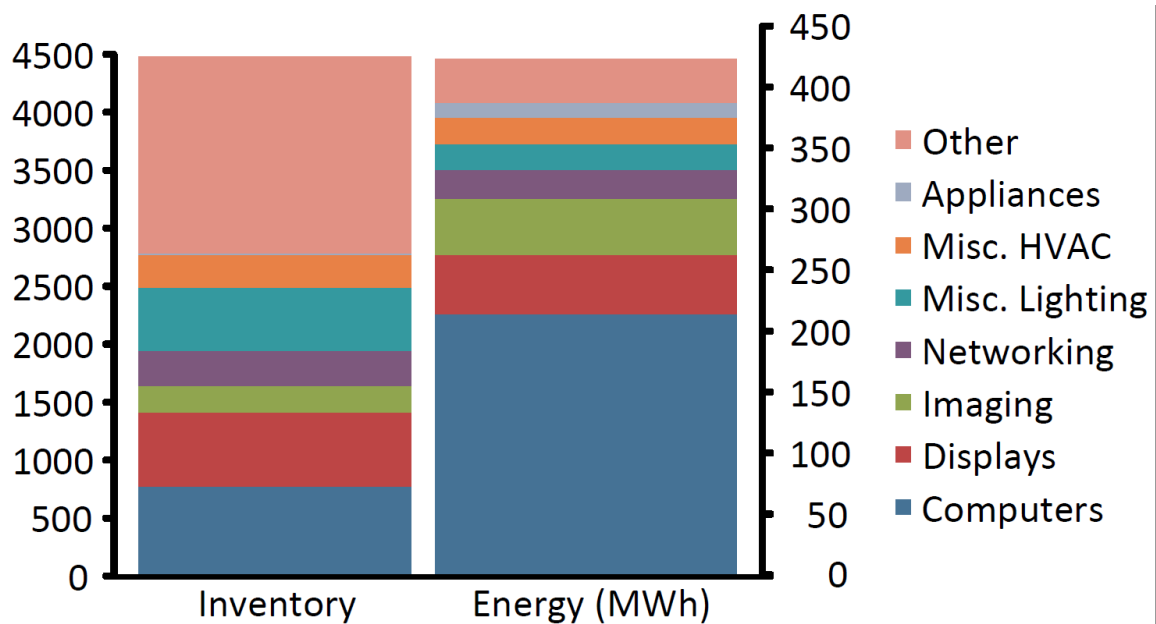

Figure 2. Inventory and Estimated Annual Energy Consumption, for the Top 7 Energy-Consuming Device Categories

In addition to these aggregate energy results, it was possible to look at aggregate power for the sample or estimated for the population for any period of time or on an average basis. In building simulation, two values for plug-loads are commonly used: the average occupied plug load power per unit area, and the unoccupied plug load power per unit area. Our study building yielded 1.1 W/ft² (12 W/m²) during the day and 0.47W/ft² (5.1 W/m²) at night, and these values are similar to those commonly used for typical buildings in the US office building stock.

Table 1 – Summary of Building Inventory and Plug Load Annual Energy Use

Device Category	Devices in Inventory	Annual Energy Use (MWh)
Other	1697	37
Appliances	21	12
M HVAC	269	22
M Lighting	544	22
Networking	300	23
Imaging	234	46
Displays	645	47
Computers	744	214

5. Methodological Results

This study was designed to look at the energy use of plug-in devices while also enabling a study of the methodology for collecting accurate energy information on annual energy use, usage patterns, and energy savings opportunities of representative plug-loads in a typical office building. At the time of our study, there were no example studies that provided empirical guidance on the selection of key study parameters. This section uses the data collected in this study to help determine, in this study building, how to optimally set study parameters. It is important to note that the conclusions drawn here are for the study building, and any other building will be different. However, we believe that these results provide a better starting point

for making study design decisions than have been available before. This section follows the methodological questions presented in the introduction.

5.1 What tools are required to effectively evaluate plug-loads energy use?

A good set of tools improves the study while reducing costs, and we looked at how earlier studies collected and managed data [5,6,7]. We adopted or improved techniques presented in these studies as possible. Researchers need a taxonomy or a standardized way to categorize devices, an inventory data collection system, an energy data collection system, and data analysis tools. Each of these will be described in this section.

5.1.1 Taxonomy

Because different names can be used to refer to the same device, we developed a taxonomy of device types, and this standardized system of identifying the device type is essential for inventory and energy data analysis. A taxonomy of MELs was developed for a California Energy Commission study [8], and we augmented this taxonomy by referencing other existing taxonomies (Energy Star product categories and California Energy Commission appliances list). We expanded the taxonomy to include newer plug-load devices as well as devices from traditional end-uses, and we included all MELs plus any plug-loads that may fall outside the MELs category. The taxonomy consists of three levels - End Use, Category, and Product Type. MELs are divided into three major end uses – Electronics, Miscellaneous, and Traditional. Electronics are devices whose primary function is obtaining, storing, managing or displaying information. Miscellaneous devices are those that use energy but are not part of a traditional end-use and are not electronics, but the end-use includes portable heating and cooling (e.g., space heaters and fans) as well as task lighting. The traditional end use includes primary HVAC, primary lighting, major appliances, and water heating. Appliances can be considered MELs in an

office building because they do not perform a business function, but we included them in the traditional category because they are broken out for analysis in CBECS. Each end use is composed of different device categories, and each category contains many product types. For example, a “LCD computer display” is a product type in the “Display” category, which is part of the end use “Electronics”. During the study, we expanded and fine-tuned the taxonomy, as we encountered new device types during the inventory or to describe certain devices in a more consistent way.

5.1.2 Inventory Data Collection System

In buildings over a few thousand square feet, understanding the type and number of devices in a building can be a daunting task. Due to the large number of devices in the building we experimented with a variety of inventory data collection mechanisms to find one that was both time efficient and reliable. Previous studies collected data either on paper with later transcription or directly into a computerized system. A comparison of these methods was not presented in earlier work.

Before conducting the extensive plug-load inventory as part of our field work, we explored different inventory methods, seeking compromise between time and effort, quality and quantity of information gathered, and minimizing disturbance to building occupants. We tested the following inventory methods:

- Voice recognition, with instant transcription;
- Paper, with electronic transcription after inventory;
- Videotaping, with electronic transcription after inventory;
- Direct electronic entry (typing) in spreadsheet.

We found that unless people had a clear set of prompts to help them remember exactly which pieces of information to collect, information was often left out. In addition, if the taxonomy was not easily available to the inventory agent, significant deviations from the taxonomy were common. As a result the first three methods resulted in lower quality data that required significant follow-up efforts to reach the desired data quality.

The direct electronic entry method was time efficient and reliable. We developed a spreadsheet based tool that contained placeholders for all of the data fields of interest. The device taxonomy was included in the spreadsheet with autocompletion in the appropriate fields, and this made it easier for people to use the taxonomy. The inventory was best done with a two-person team, with one person searching for MELs in the inventory space and reading out relevant data while the other person input data directly into a spreadsheet using a notebook computer. Over a dozen different people were involved in the inventory process with only a few minutes of introduction to the spreadsheet and the process.

5.1.3 Energy Data Collection System

In order to meter hundreds of devices for six months or more and collect data at relatively fine time steps, we found we needed a custom meter because existing, commercial meters did not meet our specifications. Previous studies used the most commonly used meters, and they log data on internal storage limited to 50,000 data points or less [9]. At a one minute sample rate, this is about one month of data. Meters with wired data collection over an Ethernet network or other physical layer were also available, but the wired data connections were not practical for our study in a standard work environment because of the large number of wires that would be required and the high-cost of the meters. At the time this study was launched, wireless plug-load meters were just entering the market, and these devices did not meet our study needs in terms of

reliability, configurability, or accuracy. In order to deploy a large number of wireless nodes in a building, it is important to limit the infrastructure required to support the network while also providing a reliable, high-speed data store. Devices available at the time could only support a handful of wireless nodes with a single manager (typically between 5 and 20) and used a simple star network topology. Our testing found that this network topology resulted in a large number of lost connections and manual reconfigurations increasing study costs. As a result we partnered with other researchers to develop a wireless metering system based on the demonstration system described in [10].

The wireless power meters used here are a research platform called ACme (“AC meter”) developed by the University of California, Berkeley and refined for use in this study. The final version used in this study consumed 0.4W per meter, had a significantly smaller form factor, and was capable of handling 15A currents for extended periods of time. Figure 3 shows the typical configuration when the ACme is connected to devices for metering, respectively.



Figure 3 ACme devices metering loads

Figure 4 shows a schematic of the overall ACme metering system design, with particular emphasis on the networking. Overall, the system can be decomposed into three tiers: the metering tier, backhaul tier, and datacenter tier. The metering tier is made up of a large number of ACmes, each containing a microcontroller, radio, and energy metering chip. ACme meters provide data readings as frequently as every second; a sampling interval of 10 seconds was selected for this study to balance network traffic and high sampling rate. Due to the small size and use of commodity parts, the purchase cost of the ACme system is approximately \$75 per node, and this four to five times less than meters used in previous studies. Each device runs the TinyOS operating system and uses the open-standard 6LoWPAN network protocol to provide IPv6 (a dynamic, scalable routing protocol) network connectivity [11]. To provide scalability to hundreds of ACmes, the Ethernet networking consists of a number of load-balancing routers

(LBRs) that provide connectivity to and from the ACmes. Each LBR advertises a minimum-cost path to neighboring meters; each meter then chooses the LBR with the lowest cost path as its default router, and sends all traffic to the selected LBR. This allowed us to increase both network and backhaul capacity by deploying new meters and routers at will. Data generated by the meters are sent in User Datagram Protocol (UDP) packets, through the LBRs, to a server in our datacenter. The LBRs reside on a single virtual subnet enabling them to coordinate routing decisions over a local broadcast domain. This is critical because it means that meters do not need to know in advance which LBR to communicate through. Instead the network configures automatically and adapts to changes and interruptions. Removing a meter or LBR from the network may result in a brief data disruption, but the network finds new paths for the data quickly minimizing data loss. The datacenter tier makes up the final part of the system, which runs a MySQL database and a hosted web application for visualization. Data packets can travel through the Internet, allowing us to share this backend infrastructure between this and meter deployments in other physical locations. A detailed discussion of the wireless network system used in this study can be found in [12].

Because of variations in the manufacturing process, all meters were tested, calibrated, and programmed before deployment to ensure accurate and consistent measurements in the field. The calibration procedure utilized 21 calibration points between 0 and 300W. The calibration revealed results revealed that reasonable accuracy can be achieved with these low cost meters. At low loads, the absolute errors is less than 1W for 97% of the meters calibrated. Additionally, more than 75% of meters are within 2% of the measured load at 50W with improved relative accuracy as the load increases.

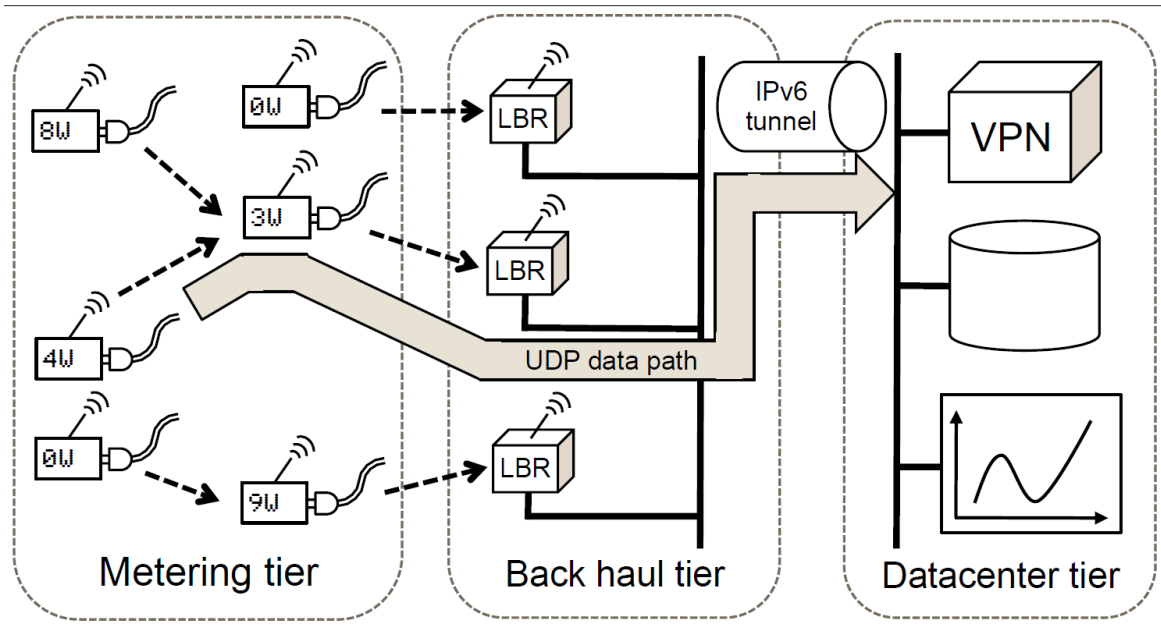

Figure 4. ACme system network design

The ACme system provided a number of advantages over the meters used in earlier studies. First the lower physical cost of the meters along with automated data collection over a network enabled the use of a much larger number of meters than in earlier studies. Automated data collection had a second benefit: the ability to detect and correct meter faults during the data collection period rather than after data collection completed. Finally, the ACmes are smaller than traditional meters making them less obtrusive to the occupants.

5.1.4 Data Analysis Tools

Collecting power measurements from a large number of meters over several months generates a large quantity of data. Storing data in text files and analyzing it using spreadsheets limits the information that can be extracted and increases the time it takes to get results, but this is the method used in [6]. The study in [7] used automated statistical analysis software. We found that dealing with hundreds of millions of data records required automated analysis tools that could access data directly from a high-speed database. By using open-source tools like Python and

MySQL, we were able to leverage the significant body of knowledge in the open source community to reduce development time.

Our analysis tools were not as important in ensuring success as the tools we used to check the status of our data collection system. In our study devices reported data in real-time to the database, and this enabled tools to automatically check which, if any, nodes had failed to report data recently. In [6], researchers found that over 10% of their meters failed in the field, but there did not learn of this until they tried to download the data from the meter. In our study the research team received a daily email report on the health of the data collection system.

Additional tools enabled researchers to identify which specific meters required attention, and someone could then check in on the meter and see if it needed to be reset. In previous studies, researchers discovered a meter had failed or had its data corrupted only at the end of the study with no opportunity to identify failures without visiting every meter. The ability to receive a daily report on the number of meters reporting data and the quantity of data reported allowed us to quickly respond to individual meter issues as well as the occasional network outage.

5.2 How much of the building area should be inventoried?

Collecting a complete inventory in a building is too time consuming to be warranted in most cases, and we thought it may be possible to inventory only a subset of the building and project this sample to the entire building with reasonable accuracy. Reducing the time spent on inventory while still capturing a realistic view of building contents enables studies in a large number of buildings. Several factors must be considered before selecting a sampling method for inventory. It is critical to review sources of variability in the inventory between different rooms so that the audit is as representative as possible. For example, if you only sample offices, you will not capture appliances located in break rooms, network equipment, and servers located in

closets, etc. It is therefore important to stratify your sample based on factors that are likely to influence room inventory. In our case study office building, there are several such room types worth separating, and we used the following space type categories.

- Offices and cubicles
- Server closets
- Network closets
- Conference rooms
- Facilities spaces
- Kitchens and break rooms.
- Rooms used for an IT function (e.g. offices of department IT workers).
- Rooms with large imaging equipment

In order to evaluate if this projection could have been done accurately in our test building, we used our complete inventory data and created random samples from that inventory of varying size. For simplicity we only considered office and cubicle spaces, but a similar technique could be used for other space types. We selected a random number of rooms and projected the inventory to the building. We repeated this random sampling a large number of times for that sample size of rooms, and we looked at the distribution of the error between the projection and the true inventory. Figure 5 shows the 90th percentile error between our projected inventory normalized by the true inventory for the buildings offices and cubicles versus the fraction of offices and cubicles inventoried. A normalized error of 0.1 means our projection was 10% from the true inventory (either higher or lower). On the plot a value of 0.1 means that 90% of the trials had an error of less than or equal to 10% from the true inventory. Device types with less variability office to office can be accurately inventoried with a smaller sample size while devices

with greater variability need a larger sample. This is apparent in that the error is lowest for computers and monitors but much higher for imaging equipment. Most offices do not have a printer, and a large sample is required to accurately characterize the number of devices in the building. The plots do not converge to zero because the maximum number of rooms in our trials was less than the total number in the building. It appears that inventorying 40% of the building makes errors less than 10% likely on computers and displays (60% of the total MELs energy use in the building). Supplementing this inventory with a complete inventory of large imaging equipment (e.g. copiers), server or network closets, and break rooms would have provided an accurate inventory in roughly half the time it took to inventory the entire building. In the study building, occupants each determine their own office equipment setup without direction from a centralized IT department. As a result, there is larger variation office to office than we have observed in other office buildings, and it seems possible that inventorying half or less of a building will enable lower cost studies with reasonable accuracy. In order to improve accuracy, offices containing a large number of computers (e.g., a group IT support person's office or make-shift server closet) should be identified before sampling and inventoried separately from the sample used for projection to the building.

5.3 What fraction of the inventoried devices should be metered?

In all but small buildings, it is impractical to meter every device of interest, and the previous commercial study [6] metered less than 7% (on average) of the plug-loads in the study buildings. The devices metered in [6] were selected first based on expected energy use but second based on convenience or accessibility rather than randomly. We selected a random sample of devices to meter, but we did not have a concrete basis upon which to select the number of devices to meter. Similar to [6] we divided up our available meters roughly according to how much energy we

thought devices consumed (i.e. we metered a greater fraction of devices that consumed more energy than those that consumed less) and according to how much variability in usage we expected to find between devices (i.e. devices with greater usage pattern variability device to device were metered with higher probability).

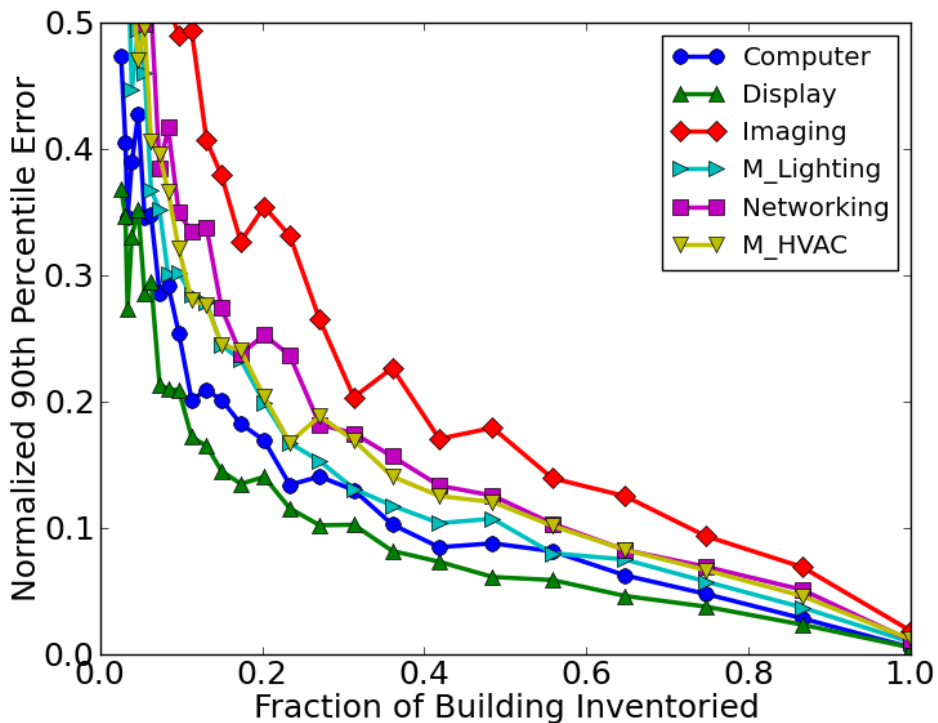

Figure 5 Normalized 90th Percentile Error vs. Fraction of Building Inventoried

If we measured enough devices in our sample, we can determine how many devices of different types we should have metered to get a specific “tightness” in our confidence intervals on energy use. Confidence intervals on annual energy use for these devices have not been calculated in previous studies. To do this for a category of devices (e.g. computers), we calculate the 90% confidence interval for the mean unit energy consumption (UEC, the annual energy use of a single device or unit) of that device category. The mean UEC for several device categories is shown in column D of Table 2. We then estimated the sample size required to provide a

confidence interval that is 25%, 20%, 15% or 10% of the mean UEC (Column E of Table 2). If a confidence interval of 20% of the mean annual unit energy consumption is taken as acceptable, computers required a sample size of 11% (i.e. 101 of 921) while imaging equipment required a sample size of about 18% (i.e. 48 of 262). As shown in Table 2, without knowing these results in advance, we over-sampled displays and under-sampled imaging equipment, miscellaneous lighting, and small network equipment. The estimates for the number of devices to sample for miscellaneous lighting and small network equipment in particular are probably not very accurate because our sample size was much smaller than needed.

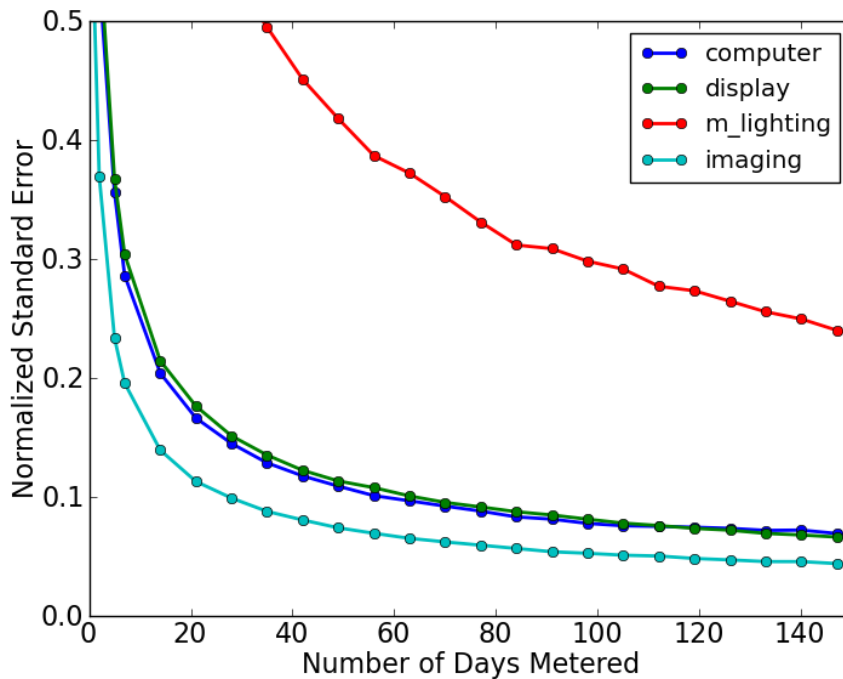

Figure 6. Normalized standard error for different metering periods, shown for computers, displays, plugged lighting, and imaging equipment

Table 2 – Sample Size versus Confidence Interval for Various Device Categories

A	B	C	D	E			
Category	population total	n sampled	Mean UEC	Normalized Confidence Interval, n required			
				0.25	0.2	0.15	0.1
Computers	744	104	287 ± 56 kWh	65	101	179	401
Displays	645	95	47 ± 4 kWh	10	16	28	63
Imaging Equipment	234	31	36 ± 9 kWh	31	48	86	192
Misc. Lighting	544	29	32 ± 10 kWh	48	75	133	299
Small Network Equipment	300	14	32 ± 14 kWh	40	62	110	247

5.4 How long should devices be metered?

Previous device-level, plug-load metering studies were limited in duration because of hardware limitations, thus the duration of many studies are determined by guessing how long of a period is long enough to accurately predict annual energy use patterns given a hardware constraint. In this study all devices were metered for over 6 months and many devices were metered for a year or more. As a result this study has the longest data set on device energy use of existing studies. Using this longer metering period, it is possible to consider various simulated metering periods for the same devices and compare annual energy estimates across different metering periods. Figure 6 shows how our estimate of total energy use by category improved with longer metering periods as compared to our best estimates of those categories energy use (best estimates were made using all metered data available for the entire metering period). To generate this plot, we tested many trials of each shorter metering period and calculated the standard error between these trials, and the standard error was normalized by our best estimate of the category annual energy use. The shorter metering periods are a random portion of the full metering period that is the number of days shown in the independent axis. This plot ends at 150

days (about 5 months) because the plot loses meaning as the number of days in the trial approaches the total number of days in the metering period, and some devices were only metered for six months.

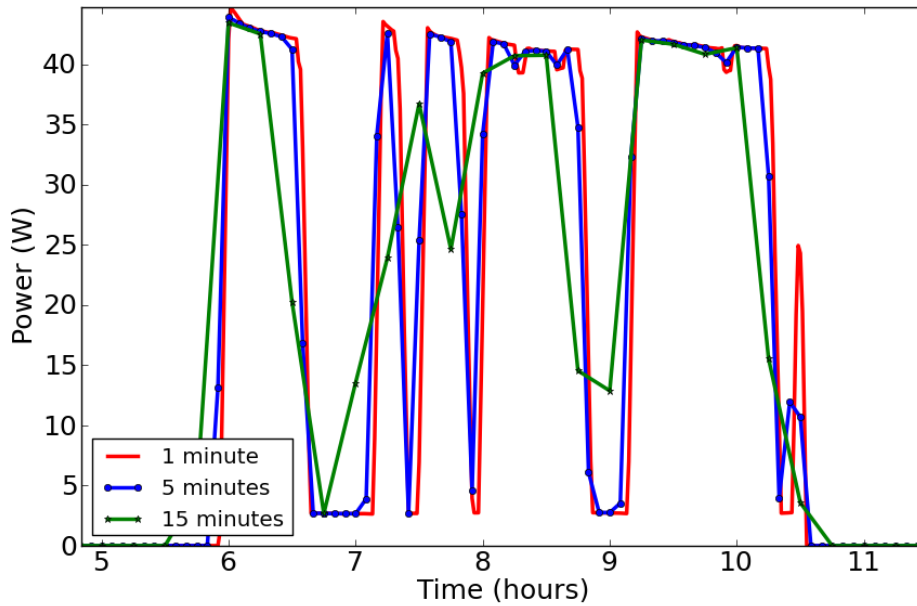

Figure 7. Time series data of a LCD computer display shown for three different data sampling rates.

The high level conclusion from Figure 6 is that for many common device categories in the study building, metering over periods longer than a few months provides little improvement in estimating annual energy use. Some categories have a high degree of variability (e.g. miscellaneous lighting which is potentially linked with seasons), and longer metering periods are needed. We estimate that metering for two months would have provided about the best tradeoff between accuracy and limiting the duration of metering in our study. This is in contrast to the only other end-use metering study of office buildings [6] where devices were metered for only two weeks. The annual energy use prediction errors that are conclusions of [6] are likely to have significant deviations from the actual annual energy use.

5.5 At what sampling intervals should power data be collected?

Previous studies used a 1 minute data collection rate from their meters. In order to verify that 1 minute data are sufficiently fast, we compared a time-in-power-mode analysis performed on 10s and 1min data and found virtually no difference in the on time for displays. Depending on the purpose of the study, the optimal sample rate will change, and hardware constraints with data logging meters will further limit choices. In our study, sampling faster than 1 minute did not provide a significant benefit, and sampling at 10 minutes resulted in a reduced ability to accurately determine the power mode levels and the time spent in each mode (an over 5% difference in on-state time for displays). If only energy information is desired, time-series power data are not required, and a single running tally of energy used is sufficient. However, understanding how much time devices spend in a given power mode is useful for improving device test procedures for efficiency labeling, to inform energy saving technology innovation, and for countless other efficiency related interests. Power meters do not report the instantaneous power at the time of sampling but rather report the average power over the last sample interval. Therefore longer sampling intervals result in a power waveform that typically looks smoother with gradual changes in power level even though the actual power used by the device may change very quickly. Figure 7 shows the time-series power data collected for a LCD computer display, as an example, to show the impact of meter sampling period on the ability to differentiate power modes in time. For this device, 1-minute data capture the dynamics appropriately, because most activity occurs on time scales greater than 1-min. The 5-min data starts to lose some resolution on the faster dynamics between hours 7 and 8, but it provides a very good estimate of the curve. The 15-min data are simply not fast enough to resolve the power trace correctly, and automated analysis of the 15-min data would likely result in some confusion

as to how long devices spent in a given power mode. The very short power spike between 10 and 11 hours is not correctly captured by 1-min data, so some events require even faster sampling. Fine enough time resolution is important for understanding the time devices spend in various power modes. For devices with few power modes and more constant power draw, such as network equipment, high resolution is not necessary to capture the device's power dynamics, whereas for devices with rapid changes in power states, more frequent samples are required to understand power draw behaviors. Although 1-min is an appropriate resolution for a majority of plug-loads, we collected power data at 10-second intervals to ensure we sampled fast enough to capture any spikes in power that may occur at frequencies less than 1 minute (e.g. the power spikes that occur when an imaging device is being powered up). In order to verify that 1 minute data are sufficiently fast, we compared a time-in-power-mode analysis performed on 10s and 1min data and found less than 1% difference in the on time. Depending on the purpose of the study, the optimal sample rate will change, and hardware constraints with data logging meters will further limit choices. In our study, sampling faster than 1 minute did not provide a significant benefit, and sampling slower than 5 minutes resulted in a reduced ability to accurately determine the power mode levels and the time spent in each mode. Our study suggests that previous study meter sampling rates have been sufficient to accurately characterize plug-loads.

6. Conclusions

Over the past decade, substantial efficiency improvements have been realized in most major end uses, making the “Other” end use a bigger share of total electricity consumption. At the same time, the increased market penetration of electronic products combined with the pace of technology change and their shorter lifecycle create challenges in understanding and reducing MELs energy consumption. Improved and focused data collection on MELs energy use is

critical in identifying mitigation strategies, but this has been difficult to implement due to the limitations of traditional power meters, the high density of MELs in commercial and residential spaces, and a lack of information on how to design effective energy studies. In this study, we deployed 455 wireless power meters in an office building with power data collected at 10-second intervals for 6 to 16 months.

This large data set allowed us to answer some important methodological questions and determine if repeating the design of earlier studies would have yielded accurate results. From our data analysis for the commercial office building, we concluded that performing a device inventory for half of the floor area and metering 10% to 20% from the key device categories for a period of 2 months, would have generated representative data for our test building. Earlier work metered fewer devices for much shorter periods of time suggesting significant errors may exist in the conclusions of these studies. These findings, although probably not representative of office buildings in general, provide the first quantitative basis published upon which to guide future plug-load metering studies.

References

- [1] US DOE. *2013 Annual Energy Outlook*. <http://www.eia.gov/forecasts/aeo/er/index.cfm>, accessed 1/22/2013.
- [2] US DOE. *2009 Buildings Energy Databook*. U.S. Department of Energy, Office of Energy Efficiency and Renewable Energy, 2011. <http://buildingsdatabook.eere.energy.gov/>. Accessed 1/22/2013.
- [3] McKenney K., Guernsey M., Ponom R. and Rosenfeld J. *Commercial Miscellaneous Electric Loads: Energy Consumption Characterization and Savings Potential in 2008 by Building Type*. TIAX LLC, 2010. <http://zeroenergycbc.org/pdf/2010-05-26%20TIAX%20CMELs%20Final%20Report.pdf>.
- [4] US DOE. 2003. *Commercial Building Energy Consumption Survey*. <http://www.eia.gov/consumption/commercial/>. Accessed January 22,2013.
- [5] S. Porter, L. Moorefield and P. May-Ostendorp. *Final Field Research Report: California Plug-Load Metering Study*. Ecos Consulting, 2006. http://www.efficientproducts.org/documents/Plug_Loads_CA_Field_Research_Report_Ecos_2006.pdf.
- [6] L. Moorefield, B. Frazer and P. Bendt. *Office Plug Load Field Monitoring Report*. Ecos Consulting, 2008, Rev. 2011.

- http://www.efficientproducts.org/reports/plugload/Revised_Office%20Plug%20Load%20Report_PIER_500-06-007_RevApril2011.pdf
- [7] I. Bensch, S. Pigg, K. Koski, and R. Belshe, 2010. *Electricity Savings Opportunities for Home Electronics and Other Plug-In Devices in Minnesota Homes: A technical and behavioral field assessment*. Madison, WI: Energy Center of Wisconsin. ECW Report Number 257-1. May. <http://www.ecw.org/ecwresults/257-1.pdf>.
 - [8] B. Nordman and M. Sanchez. *Electronics Come of Age: A Taxonomy for Miscellaneous and Low Power Products*. Proc. of the 2006 ACEEE Summer Study on Energy Efficiency in Buildings. Ed.: American Council for an Energy Efficient Economy, Washington, DC: 2006.
 - [9] WattsUp?. 2013. “Watts up? PRO ES Specificatins.” <http://www.wattsupmeters.com>. (accessed January 22, 2013).
 - [10] X. Jiang, S. Dawson-Haggerty, P. Dutta and D. Culler. *Design and Implementation of a High-Fidelity AC Metering Network*. Proc. of the The 8th ACM/IEEE International Conference on Information Processing in Sensor Networks (IPSN’09) Track on Sensor Platforms, Tools, and Design Methods (SPOTS ‘09). Ed.: Association of Computing Machinery, 2009.
 - [11] S. Dawson-Haggerty. *Design, Implementation, and Evaluation of an Embedded IPv6 Stack*, Masters thesis, Computer Science – Electrical Engineering and Computer Sciences, University of California, Berkeley, 2010.
 - [12] S. Dawson-Haggerty, S. Lanzisera, J. Taneja, R. Brown, and D. Culler. “@scale: Insights from a Large, Long-Lived Appliance Energy WSN”. *in* Proceedings of the 11th ACM/IEEE Conference on Information Processing in Sensor Networks, SPOTS Track (IPSN/SPOTS '12), April 2012.
 - [13] B. Acker, C. Duarte, K. Van Den Wymelenberg, “Office Space Plug Load Profiles and Energy Saving Interventions,” Proc. of the 2012 ACEEE Summer Study on Energy Efficiency in Buildings, Pacific Grove, CA, 2012.