



Lawrence Berkeley Laboratory

UNIVERSITY OF CALIFORNIA

ENERGY & ENVIRONMENT DIVISION

Presented at the Heat and Mass Transfer in Building Materials and Structures Conference, Dubrovnik, Yugoslavia, September 1989 and published as a chapter in *Heat and Mass Transfer in Building Materials and Structures*, J.B. Chaddock and B. Todorovic, Eds., Hemisphere Publishing Corporation, Washington, D.C., 1990

Description of a System for Measuring Interzonal Air Flows Using Multiple Tracer Gasses

M. Sherman, H. Feustel, and D. Dickerhoff

April 1989

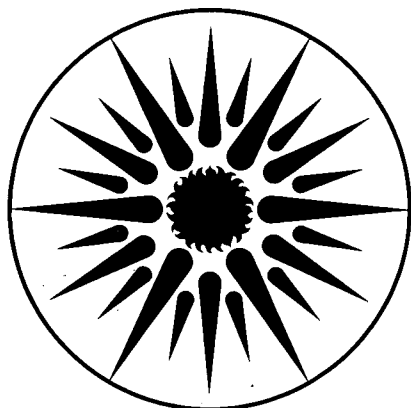

ENERGY & ENVIRONMENT
DIVISION

LOAN COPY
Circulates
for 4 weeks
Bldg. 50 Library.

LBL-26538

Copy 2

DISCLAIMER

This document was prepared as an account of work sponsored by the United States Government. While this document is believed to contain correct information, neither the United States Government nor any agency thereof, nor the Regents of the University of California, nor any of their employees, makes any warranty, express or implied, or assumes any legal responsibility for the accuracy, completeness, or usefulness of any information, apparatus, product, or process disclosed, or represents that its use would not infringe privately owned rights. Reference herein to any specific commercial product, process, or service by its trade name, trademark, manufacturer, or otherwise, does not necessarily constitute or imply its endorsement, recommendation, or favoring by the United States Government or any agency thereof, or the Regents of the University of California. The views and opinions of authors expressed herein do not necessarily state or reflect those of the United States Government or any agency thereof or the Regents of the University of California.

*Published in Proceedings of the
ICHMT, Heat and Mass Transfer
in Building Materials and Structures,
September 1989, Dubrovnik, Yugoslavia*

LBL-26538

**Description of a System for Measuring Interzonal
Air Flows Using Multiple Tracer Gases**

Max Sherman, Helmut Feustel
and Darryl Dickerhoff

Energy and Environment Division
Lawrence Berkeley Laboratory
University of California
Berkeley, CA 94720

April 1989

This work was supported by the Assistant Secretary for Conservation and Renewable Energy, Office of Buildings and Community Systems, Building Systems Division of the U.S. Department of Energy under Contract No. DE-AC03-76SF00098.

DESCRIPTION OF A SYSTEM FOR MEASURING INTERZONAL AIR FLOWS USING MULTIPLE TRACER GASSES

Max Sherman
Helmut Feustel
Darryl Dickerhoff

April 1989

Energy Performance of Buildings Group
Indoor Environment program
Applied Science Division
Lawrence Berkeley Laboratory
University of California
Berkeley, CA 94720

Mass transfer due to pressure-driven air flow is one of the most important processes for determining both environmental quality and energy requirements in buildings. Heat, moisture, and contaminants are all transported by air movement between indoors and outdoors as well as between different zones within a building. Measurement of these air flows are critical to understanding the performance of buildings.

Virtually all measurements of ventilation are made using the dilution of a tracer gas. The vast majority of such measurements have been made in a single zone, using a single tracer gas. In recent years, the need to determine ventilation rates/air flows in multizone buildings has become more acute, and many researchers have been devoting effort to the problem. In some cases clever control schemes have been utilized to allow some inferences to be drawn from a single tracer gas but a full determination of the air flows requires multiple tracer gasses. Those multiple tracer systems that have been developed tend to suffer limitations due either to response time, number of zones, or bias.

For the past several years LBL has been developing the MultiTracer Measurement System (*MTMS*) to provide full multizone air flow information in an accurate, real-time manner. *MTMS* is based on a quadrupole mass spectrometer to provide high-speed concentration analysis of multiple tracer gasses in the (low) ppm level which are injected into multiple zones using mass flow controllers. The measurement and injection system is controlled by a PC and can measure all concentrations in all zones (and adjust the injected tracer flows) within two minutes and can operate unattended for weeks. (See diagram on reverse side.) It also can measure related quantities such as weather and zonal temperature to assist in the data interpretation. *MTMS* uses a real-time algorithm to estimate the air flows both to improve the control and to provide real-time information to the user. A more detailed off-line analysis methodology is utilized to provide more accurate estimates of the air flows.

This report will describe the system and the data it has produced. *MTMS* has been in field operation since January of 1988 and has been used in two to five zone dwellings. Experimental conditions have ranged from steady driving forces to rapid changes, from poorly mixed zones to forced air heating systems, and from poorly coupled apartments to tightly coupled single-family houses. Since the response time of the analysis is well under an hour, occupant effects such as door openings between zones can easily be seen; since the post-processing response-time can be made quite short, even forced-air-fan cycling can be observed. In all cases the system has proven able to maintain control and provide data from which air flows can be calculated.

INTRODUCTION

The MultiTracer Measurement System (MTMS) has been designed to make real-time, multizone air flow in buildings. MTMS injects a controlled amount of various tracer gasses into the test space(s) and by monitoring the resultant concentration, can estimate the relevant air flows. The system fills the twin needs for the determination of pollutant and energy transport.

This report describes MTMS including its hardware, principle of operation, and analysis techniques. Finally, we present results selected from its first year of operation as an example of its capabilities.

Background

Tracer gasses are used for a wide range of diagnostic techniques including leak detection^{1,2} and atmospheric tracing.³ One application which has had a resurgence in the last decade is the use of tracer gasses to measure ventilation (i.e., air flow) in buildings.⁴ Ventilation is an important process in buildings because of its impact on both energy requirements and indoor air quality—which are both topics of concern to society. Measurement of the tracer gas concentration and source emission combined with conservation laws allows a quantitative determination of the tracer transport mechanism (i.e., a *measurement* of the air flow).

The vast majority of the ventilation measurements made to date have involved a single-tracer gas deployed in a single zone. This technique has proven very useful for buildings which may be treated as a single zone (e.g., houses) and for more complex buildings in which there are isolatable sub-sections. However, as the need to understand more complex buildings has grown, tracer gas techniques that are able to treat multiple zones have been developed.⁵ Multizone techniques recognize that not only does air flow between the outside and the test space, but that there are air flows between different parts (i.e., zones) of the test space and, in the complete case, they are able to measure these flows. Accordingly, the complexity of multizone measurement techniques grows at least as fast as the square of the number of zones.

Multizone Continuity Equation

The continuity equation expresses the conservation of tracer gas. In a general multizone environment, a *matrix* form of the continuity equation must be used:

$$\mathbf{V} \cdot \dot{\mathbf{C}}(t) + \mathbf{Q}(t) \cdot \mathbf{C}(t) = \mathbf{S}(t) \quad (1.1)$$

For every zone of the system there will be a row in both the concentration and source-strength matrices. For every unique tracer gas there will be a column in those matrices. If there are N zones, the volume and air flow matrices will be square matrices of order N

and the continuity equation can be rewritten with explicit indices:

$$\sum_{j=1}^N \left[V_{ij} \dot{C}_{jk}(t) + Q_{ij}(t) C_{jk}(t) \right] = S_{ik}(t) \quad (1.2)$$

In MTMS there are as many tracer species as there are zones. (Such a problem is called *complete* and yields a unique answer.)

Eq. 1 contains measured data and derived quantities. The measured data are the flows and concentrations of each tracer gas in each zone. Specifically, \dot{C}_{ij} , C_{ij} , and S_{ij} all represent the respective value of the j th tracer gas in the i th zone. In MTMS the volume matrix is diagonal and contains the zone volumes. The flows to and from outside are implicit in the matrix and can be found by summing a row or column appropriately; often the matrix is expanded to include this value as a zeroth row and column. If, however, there is *short circuiting* of the tracer source from one zone to another, it can manifest itself as an off-diagonal volume element, but the sum of each column must be equal to the (effective) physical volume of the zone—such behavior is not treated in MTMS.

The interpretation of the air flow matrix requires a bit more explanation. The diagonal elements, Q_{ii} , represent the total flow out of that zone to all other zones and should have positive sign. The off-diagonal elements represent the flows between zones; specifically, $-Q_{ij}$ is flow from the j th zone to the i th zone. Since the flow from the j th zone to the i th zone can be different from the flow from the i th zone to the j th zone, this matrix will in general not be symmetric.

The flow matrix explicitly contains information about flows between measured zones and the total flow. If there are flows to zones other than those being measured (e.g., outside), the sum of some rows and columns of the flow matrix will be positive; and system is said to be *open*. If all zones of the building are monitored these flows to “elsewhere” are attributed to air exchange with the outside.

MTMS PRINCIPLES OF OPERATION

MTMS, like all tracer-gas ventilation-measuring systems, uses the dilution (or non-conservation) of a tracer gas to infer air flows. In order to do this the system must be able to perform certain functions: injecting controlled amounts of tracer gasses into specified zones, measuring the concentration of the tracer gasses in all the zones, and storing the resultant information for later use. MTMS is able to do these functions using a PC controlled data logging and control system.

Control Strategy

Under perfect conditions almost any method of injecting the tracer gasses into the zones would lead to a good estimate of the air flows; but, as discussed in later sections, the accuracy and precision of the air flow calculation depends on many factors: instrument capabilities, relative size of air flows, mixing, the conditioning of the concentration matrix, etc. The purpose of the control algorithms in MTMS is to minimize the uncertainty in the data analysis by suitable control of the injected flow. The subject of optimal control is, of course, an entire discipline (See, for example, Bryson.)⁶ and will not be described herein. The control strategy used in MTMS is an attempt to minimize errors due to several different sources as follows:

Instrumentation Accuracy: The precision of the injection and concentration determination is usually an absolute value expressed as a percentage of full scale. To minimize the impact this uncertainty has in the calculation it is desirable to maximize the signal.

Mixing: When tracer is injected into a perfect zone, it is completely and instantly mixed. In a real zone it takes some time for the measured concentration to reflect the zone average concentration. This kind of mixing effect can be reduced by keeping a steady injection and concentration within the zone rather than allowing the zone to fluctuate. (Other types of mixing effects such as stratification, dead zones, short-circuiting, etc. require careful sampling design and cannot be dealt with in by the control strategy.)

Matrix Conditioning: The analysis method includes the inversion of the concentration matrix. Uncertainties in the measured quantities and numerical errors will be amplified if the concentration matrix is ill-conditioned. (The best conditioned matrix would be diagonal; the worst would have a zero determinant.) Although the conditioning of the concentration matrix will be to some extent limited by the conditioning of the problem (i.e. the air flow matrix), the control strategy should seek to keep the concentration matrix well-conditioned.

The MTMS control strategy is a compromise between these objectives. A single, unique tracer gas is injected into each zone. Thus, the concentration of that gas in that zone will be largest; if there were no air flow between the zones this would lead to a perfectly conditioned concentration matrix. Given that it is not possible to inject a negative amount of tracer gas, this strategy leads to a maximally well conditioned concentration matrix. For the single tracer to be injected into each zone a target concentration, C_i is chosen so as to maximize the dynamic range of the instrumentation and thus minimize the instrumentation-induced errors.

The control algorithm used in MTMS is type of proportional-integral control scheme that separately controls the injection of each tracer gas based on the concentration of that tracer in the zone in which it is injected. In operation the change in the injection of each tracer gas is calculated from the distance away the estimated concentration is from the

target and on how much the estimated concentration has changed since the last cycle:

$$\Delta S = \frac{V}{\tau_i} \Delta C_t - \frac{V}{\tau_p} \Delta C_e \quad (2)$$

The values of the two time constants in this equation determine the characteristics of the control. C_e represents an estimate of what the concentration will be at the end of the next cycle—should no change to the injected flow be made. ΔC_t is the difference between the target concentration and the estimated concentration.

The integral time constant, τ_i , is the characteristic time for the system to reach its target concentration (e.g. from zero). The shorter this time constant is, the quicker the system will reach target and the effect of instrument error will be minimized. However, if τ_i is too short the system will be unstable. Instability will set in if the time constant is too short compared to 1) the sampling rate, 2) the mixing time, 3) τ_p , and 4) any imaginary eigenvalues in the air flow matrix. Since instrument error is not a major problem for MTMS, we have selected a relatively long integral time constant to insure stability.

For MTMS the default value is $\tau_i = 1 \text{ hour}$.

The proportional time constant, τ_p , regulates how fast the concentration is allowed to change. The shorter this time constant is, the smoother the concentration time series will be. Since changes in concentration can cause errors when they happen faster than the mixing time, the optimal value for this time constant is the mixing time. In order to promote stability, the proportional time constant should lie between the sampling time and the integral time constant.

For MTMS the default value is $\tau_p = 15 \text{ minutes}$.

On-Line Analysis for Estimating Concentration

The control algorithm requires an estimated concentration to be calculated. This concentration, C_e , is that concentration that would occur if there were no changes made to the amount of tracer injected. Since in normal operation the concentration is slowly varying, the most obvious candidate for the estimated concentration is the current measured concentration. One reason for not using the measured value is that it is least representative when the system is farthest from steady-state and thus may contribute to instability. Furthermore, if the air flows are high enough using the measured value ignores the interactions between zones. A more important reason is that the measurement of concentration is subject to random noise caused by a variety of factors one of which is poor mixing. Such noise will cause the control algorithm to needlessly alter the injection and magnify the concentration fluctuations.

One way to avoid these problems to extrapolate the current estimated concentration from the previous estimated concentration and the system properties (i.e. injection rate, concentrations, and air flows) using the continuity equation. Since we, of course, do not *a priori* know the air flows, they must be calculated in real time from the data already taken. The disadvantage of such a procedure is that we may not be able to determine the air flow well enough to get a meaningful extrapolation.

Both these approaches have advantages and disadvantages; the optimal solution is to combine them together as follows:

$$C_e = C_m + \kappa \left[C_{ext} - C_m \right] \quad (3)$$

Such an approach is called *Kalman filtering*. In MTMS the Kalman gain, κ , is initially set to unity: as the on-line analysis is better able to estimate the air flows, κ is steadily decreased to a minimum of 0.4. Should the analysis have difficulty determining the air flows, the Kalman gain is increased back to unity. This adaptive form of Kalman filtering helps keep the concentrations stable even when the air flows are changing.

The control algorithm of the previous section shows no indication that the system being controlled is coupled (i.e. multizone). Each injected tracer is controlled by its estimated concentration in a single zone. However, the coupled character appears in the calculation of the extrapolated concentration. Using equation 1 we can find the extrapolated concentration from the current flows and previously calculated estimated concentration:

$$C_{ext} = C_e + \delta t V^{-1} \cdot \left[S - Q_e \cdot C_e \right] \quad (4)$$

The required concentrations are the diagonal terms of left hand side.

In order to use this expression it is necessary to have an estimate of the current air flows. We make this estimate in real time using an averaged value of the concentrations and injections to get an estimate of the current air flows:

$$Q_e \equiv \left[\overline{S - V \cdot \dot{C}} \right] \cdot \overline{C}^{-1} \quad (5)$$

where the overbars indicated a digitally filtered value (with a one hour time constant) of the measured quantities.

MTMS uses this on-line calculation in the control algorithm and to give immediate feedback to the user in the field. The algorithm is not sufficiently accurate for a complete data analysis necessitating an off-line analysis technique, which is described in a later section.

MTMS HARDWARE DESCRIPTION

The MTMS hardware is responsible for measuring the concentrations of all gasses in all zones and for injecting tracer gasses into those zones in order to effect the control strategy. The core of the system is the measurement of concentration and it is supported by plumbing and control technology. Total cost for the hardware (not including fabrication labor) described below was about \$33,000. Figure 1 shows a diagram of the MTMS hardware.

Analysis of Concentrations

Accurate and timely measurement of the tracer gas concentrations is the constraint which is most demanding of the instrumentation and has required new methods. Mass spectrometers have long been used as a detector for chromatography, but until recently they have been too large and too costly for typical tracer gas analysis. Currently Residual Gas Analyzers (RGAs), quadrupole mass spectrometers, are small, reliable, and available at prices comparable to gas chromatographs. Their principal use is in process gasses in vacuum, where both desired components are monitored as well as contaminants. Typical contaminants are air leaks, background oil or water, undesired chemical reactions, even some metals which might be present in the materials used for construction of the vacuum chamber.

Air coming into an RGA is ionized and the resulting positive ions are separated by their charge-to-mass ratios and directed at an electron multiplier for detection. Separation is achieved by directing the ions axially between four rods and varying an electric field on the rods at radio frequencies. A stable path is setup for one charge-to-mass ratio at one frequency and only it will emerge at the end of the rods. Tracer gas concentration is then proportional to the output current of the electron multiplier. This process must take place at low pressures, less than 10^{-5} torr, so that the ions within the quadrupole mass filter do not collide with other species (neutral or ionic).

When a new air stream is selected it must flush out the ionization area before its concentration can be measured. In MTMS the ion source, a hot wire, is open to all of the vacuum chamber. The chamber, with a volume of about one liter, is pumped with a 50 liter/sec turbomolecular pump. This provides several air changes/second and insures fast response. Changing measurements from one gas (ion) to another within the same sample is simply a matter of changing the radio frequency.

The sample air pressure must be reduced to that required by the RGA. A multistage reduction in pressure is necessary to meet the pressure requirements. The first reduction is achieved by flow resistance within a small capillary tube. This reduction is limited to the pressure at which molecular flow is induced. The pressure is now reduced by expansion into a small chamber from which a small portion is allowed to expand into the RGA via an orifice, the bulk of the gas is pumped away with the vacuum fore pump. This

process limits the response time by the travel time in the capillary and the flushing of the expansion chamber with the fore pump. Including the valve manifold, the overall response time of the MTMS hardware is about one second.

The oils used in the vacuum pumps are large hydrocarbons and even small amounts of their vapors that backflow and any oil that creeps along the chamber walls can give rise to ions at almost every mass of interest. This *background* can be reduced by one or two orders of magnitude with the use of a catalytic oil trap. An oil trap will also help to keep the electron multiplier clean.

The RGA itself has an absolute accuracy of about ½% of reading; however, at the pressures we are working there is electronic noise of about 20 ppb. Most tracer gasses can be calibrated to ±1% down to 2 ppm where the noise dominates the uncertainty. Gasses with large backgrounds may have to be used at higher concentrations to maintain the same uncertainty, (e.g. helium at 5.25 ppm background will have a minimum uncertainty of 53 ppb). The electron multiplier is less sensitive to heavy ions and so it is necessary to use slightly higher concentrations for gasses such as sulfurhexafluoride. For MTMS gasses the typical target concentration (i.e. the concentration in the zone in which they are injected) are from 20 to 50 ppm to allow the non-target concentrations to be measured with some accuracy.

Injection of Tracer Gas

The tracer gas injection is controlled by a separate Mass Flow Controller (MFC) for each gas. These devices measure the mass flow with a precision hot wire anemometer (or hot films) and control a needle valve to regulate the mass flow to within 1% accuracy (full scale) in a 50:1 operating range. These specifications are often exceeded in practice where one can sometimes get a 70:1 range and better low end accuracy. Response time is typically under 10 seconds, occasionally some adjustments are necessary to the controls when changing gas type or flow range. Typically the MFCs require a driving pressure of at least 5 psi, and give optimal performance at about 20 psi. This limits the selection of tracer gasses to those which have sufficient vapor pressure at operating temperatures. Tanks of at least 98% purity are used with 99.9 % or better preferred. Diluted gas can also be used and is suggested for safety reasons if flammable gasses are to be employed. The simple hydrocarbons typically have lower combustible limits at about 2% thus requiring about 50 times more diluted tank gas than pure gasses. This usually requires several tanks for an experiment and is inconvenient.

Tracer gas is transported to the zones via tubing from the rack of MTMS equipment. The tracer gas is often injected at multiple locations and small fans are used to make sure that mixing occurs. Poor mixing is usually the biggest source of error in the measurements. Preferably the tanks of tracer gas are stored outside where a small leak will not interfere with the measurements and a large leak (damaged tubing) will not cause the gas

concentrations to rise above safety limits. Some tubing types are incompatible with some tracer gasses, specifically Teflon tubing and sulfur hexafluoride are a poor combination. MTMS uses quarter inch polyethylene tubing which has worked well with all the tracer gasses used. Smaller tubing could decrease response time but the added resistance would limit the selection of tracer gasses to those with sufficient pressure to insure adequate flow.

The desired flow rate is requested by a 0 to 5 volt signal from the controlling computer. This can be manually overridden when desired. The actual flow is measured via a separate 0 to 5 volt signal.

Tracer Gas Selection

There are several factors governing the selection of tracer gasses. The ideal gas is non-toxic, non-flammable, inexpensive, readily available, and easy to detect. An RGA is able to detect almost any gas, giving great flexibility but also difficulties from interfering gasses. The gasses selected must produce a characteristic ion. Normal air is a mixture of many compounds and the ions produced from its components may obscure desirable tracer gas ions. Several tracer gasses have been identified for use, mainly from the Freon family. Unfortunately Freons do not yield a positive ion by losing one electron from the parent molecule. Their detection is accomplished via fragments such as (for Freon 12): $CF_2Cl_2 + e^- \rightarrow CF_2Cl^+ + Cl^- + e^-$. Many Freons can produce similar fragments, such as (for Freon 114): $C_2F_6Cl_4 + e^- \rightarrow 2CF_2Cl^+ + 3e^-$. Many such fragments are possible for each gas. Some interferences can be accounted for and these gasses can still be used. For example it is desirable to use Freon 22 and sulfur hexafluoride as tracer gasses, but sulfur hexafluoride produces ions at mass 127 and 51 and the only usable mass for Freon 22 is also mass 51. The contribution of sulfur hexafluoride at mass 51 is 7.6% of its value at mass 127. When this value is subtracted from the value at mass 51 the result comes only from Freon 22. Table 1 shows the gasses (and their fragments) which have been selected for possible use in MTMS.

TABLE 1: MTMS TRACER GAS PROPERTIES			
GAS	ION	MASS	COMMENTS
He	He^+	4	background of 5.24 ppm
SF ₆	SF_5^+	127	interferes with Freon 22 present at 7.6% of peak at mass 127
	SF^+	51	
Freon 22	CHF_2^+	51	interferes with Freon 13B1 or Freon 14 present at 2.1% of peak at mass 51 interferes with Freon 12 present at 1.5% of peak at mass 51
	$CHClF^+$	69	
	$CHCl_2^+$	85	
Freon 12	$CClF_2^+$	85	
Freon 13B1	CF_3^+	69	
Freon 12B2	CF_2Br^+	120	not commonly available
n-Butane	$C_4H_{10}^+$	58	flammable above 2%
	$C_3H_7^+$	43	
Ne	Ne^+	20	background of 18.18 ppm, expensive
Ar	Ar^+	40	background of 1%, used as internal reference
<i>Note: Only the masses for the most abundant isotopes are listed.</i>			

Helium has a relatively large background but because it is inert and is available at low cost it can be used at relatively high concentrations (lower limit at about 100 ppb). Helium, because it is incombustible, can also be used to measure flow through combustion devices. Freon 22 is generally used after exhausting other choices because of the interferences. Most of the Freons are available at only 98% purity and may have significant amounts of other Freons mixed in. For this reason each tank must be measured to determine the contamination, and small interference corrections are usually needed for all the Freons. Other gasses of interest, such as CO_2 and H_2O , can also be monitored.

Sampling System

Air is pumped from each zone, and outside, continuously using a *free piston* pump to a valve manifold where one air stream is selected for measurement. The tubing and pump size were matched so that it takes at most 10 seconds for zone air to reach the analysis equipment. The same concerns that were noted for the injection tubing are again

present for sampling. Additionally some adsorption may occur. This is usually only a problem at very low concentrations (ppb or less). At the concentration levels which MTMS is used this is not a problem. It is possible to use injection tubing for sampling after sufficient flushing. The free-piston pump was selected because it is leak free and relatively quiet.

Care must be taken to prevent possible condensation or freezing of humid air (and so blocking the tubing) as it travels through cold areas. Usually this means that the tubing must all be inside the structure being monitored during cold weather. Alternatively the tubing could be heated in exposed areas. The flow rate is low enough that self heating is not feasible without extensive insulation. Additional samples (i.e. measurements not used in the MTMS control) may be taken from other locations such as attics or ducts, or near suspected leakage sites.

Computer Data Acquisition and Controls.

The various functions necessary for MTMS operation are performed via a host PC computer which communicates via serial ports to the RGA interface and a data acquisition computer. The data acquisition computer runs a simple program to interpret requests from the PC and read various voltages or temperatures, outputs the controlling voltages for the mass flow controllers, and operates the valves which select which zone is to be analyzed. Usually there is a weather tower to measure temperature, wind speed, and direction and one temperature for each zone. Other sensors may be monitored as well, such as barometric pressure, and HVAC operation.

The RGA Interface interprets requests from the PC and operates the RGA. It can select amplifier gain, select measurement mass, and measure the intensity of the ion signal. There are several other functions intrinsic to the RGA which can be accessed, such as selecting ionization filaments, degassing, total pressure measurement, detector choice, and electron multiplier voltage. Each nominal mass peak is measured at a series of masses which vary around the nominal mass by up to \pm one third of a mass unit. The result is curve fitted to find the center and peak height. This procedure reduces the effects of noise and tracks whatever drift there may be in mass position. Because there may be background, either from natural sources as for helium or from oils, outside air is measured and any resulting peak is subtracted. All tracer gas measurements are made relative to the naturally occurring Argon peak. Small changes in total pressure, due to tubing resistance or pumping efficiency, or changes due to electron multiplier efficiency drift are thus accounted for.

Overall response time is limited by the serial I/O between the PC and the RGA Interface. It generally takes between 5 and 10 seconds per gas depending on the concentration. Typically for a 3 zone measurement it takes about 110 seconds to measure all four gases in all four zones, (outside counts as a zone, and the argon reference counts as

a gas).

After each zone has been analyzed the flow rates are estimated and new injection rates are calculated using the method described above and set via the data acquisition computer. The results are printed to the monitor and to a disk file for subsequent more sophisticated analysis. The analysis is not dependent on constant concentration and the injection control parameters are usually set for long (about one hour) time constants.

MTMS DATA ANALYSIS METHOD

The data analysis method used to reduce the data is considerably more complex than the on-line method used in the control algorithm. Inversion of eq. 1 is a straightforward mathematical problem indicated by eq. 5 above. If there were no uncertainty in the measured data (i.e., the concentrations and source strength), this inversion would give the correct (and only) answer. In any real experiment, however, there will be uncertainty in the measurements due either to instrumentation errors or other random processes. Such uncertainty can be described by a probability distribution as to where the true value lies. Tarantola⁷ gives an excellent discourse on the issues related to the general problem of extracting model parameters from measured data.

In MTMS there are many sources of error which tend to confound the extraction of the air flows from the measured data. The random errors can be expressed as uncertainties in either the injected flow or measured concentrations. From these uncertainties the precision of an individual calculation of air flows can be determined.⁸

Because MTMS takes a large volume of data—each hour there are about thirty full measurements consisting of injection rates and concentrations for each gas in each zone—the precision of an air flow estimate can be improved. The most robust method of increasing the precision is to integrate the continuity equation (eq. 1) over a specified period and treating the air flows as constant over that period. The longer the integration time, the better will be the precision. If, however, the integration time is so long that the real air flows vary significantly, a non-negligible bias—typical of the passive ventilation measurement techniques—will be introduced.⁹ The selection of the optimal integration time constant requires some prior knowledge about the system; however, for houses without mechanical systems, this time is typically on the order of one hour.

Both the precision and accuracy of the calculated air flows can be improved by incorporating physical knowledge about the system. For example, the air flows are only defined in only one direction; physically impossible signs for the air flows can be eliminated. Similarly, the high data rate allows us to restrain the rate of change of the air flows in time to physically reasonable limits. The details of the analysis are beyond the scope of this report, but can be found in the literature.¹⁰

Mixing and the Zonal Assumption

Virtually all tracer gas techniques for estimating air flows in buildings (MTMS included) use the *zonal assumption* which is that the volume of the building can be broken up into a set of zones inside of which there is a constant concentration of tracer gas. In other words it is assumed that all flows out of a zone contain the average concentration of gasses within the zone and that all incoming air (and tracer) is quickly mixed. Thus, a zone is characterized by its mixing properties and not its physical size or shape; a zone may be a set of rooms, a single room, or a part of a room.

The idealized condition of perfectly well mixed zones is rarely realized in practice, but we have observed that it can be reasonably approached by using fans to stir the air within each zone. Such fans can be explicitly installed for mixing or can be part of the HVAC system in the building. MTMS has small fans to infuse the injected tracer evenly into each zone; and, where practical, oscillating fans are used to mix the air within each zone. Mixing fans should not be located where they might change flows between the zones (e.g. pointed at a leakage site).

Should the mixing be insufficient, the zonal assumption will breakdown and errors can creep into the analysis. When the breakdown occurs concentrations at different points within the zone will have different values. These intrazonal concentrations can vary both spatially and temporally.

If the poor mixing is caused by pockets of air having different concentrations traveling chaotically through the zone, one could assume that the concentration time-averaged over a long enough interval is the same at every point within the zone. In such a case the imperfect mixing can be treated as an extra uncertainty in the concentration measurement. In most real zones, this kind of uncertainty will be larger than the instrumental error of MTMS. We can use the high data rate of MTMS to estimate the magnitude of this uncertainty for every concentration and use that value in the analysis procedure.

Not all mixing problems can be treated as random errors. If for example the zone has a spatial concentration gradient (e.g. if it were temperature stratified) there is no single value of concentration that represents the zone. Even a spatial average of the concentration may not be representative. This kind of systematic error can cause a bias in the analysis, which cannot be eliminated by increasing the uncertainties. Biases can also be caused by averaging concentrations over periods longer than the characteristic time change of the air flows.

Biases in general cannot be uncovered by examining the quality of the data. However, the air flows are physically constrained to lie in certain ranges (i.e. non-negative air flows). It often happens that biases in the data cause the apparent flows to violate the physicality constraints. Such violation can be used to indicate that some sort of bias may be present. However, such biases may be present and *not* cause a violation of the physicality constraints. Therefore, good measurement technique should include an independent verification of acceptable mixing.

FIELD MEASUREMENTS USING MTMS

MTMS was in continual use from the completion of its laboratory debugging in fall 1987 through spring of 1988. During this period the system was used in four different states covering three different regions of the country and including both single and multifamily buildings and both occupied and unoccupied zones. The data covered below will be for occupied and unoccupied single-family houses. During this time MTMS was part of a tracer gas technique intercomparison, in a multifamily building¹¹ and in a study of Radon dynamics in a single-family home.¹²

Unoccupied House

The first field use of MTMS was in a wood frame bungalow-style, single-family house in Berkeley California. The house is made up of four zones; a bedroom, a kitchen/living area, a large storage room, and a laundry room. The laundry and storage rooms are below the rest of the house. From the layout one would not expect much direct communication between the bedroom and the storage room. These zones have volumes of 61, 243, 60, and 30 m³ and floor areas of 25, 100, 30, and 15 m², respectively. The total effective leakage area of the house was measured at 800 cm², and the major leakage between zones is expected to be around the doors that connect them. The house was built around 1935 and has a floor furnace in the living room.

The period selected for display was a period during the Christmas holidays in which the occupants were not in residence and the heating system was not in operation. Several small fans were used to insure adequate mixing in all zones. The conditions were selected to be as benign as possible for the first test in field conditions.

Figure 2 is a plot of the measured air flows over a day and a half period beginning on December 24. The measurement time constant is half an hour. Figure 2a shows the flows to the Bedroom from all the other zones; figure 2b shows the flows to the Living room from all the other zones; figure 2c shows the flows to the Storage room from all the other zones; figure 2d shows the flows to the Laundry room from all the other zones. During the first evening a door between the storage room and the laundry room was opened and was then closed around the following noon. As can be seen the flows between the two affected zones change dramatically, but secondary effects on the other flows are also observable. It should be noted that the infiltration (i.e. flow from outside) is visibly increased when the internal resistance is lowered by opening an internal door. Furthermore the number of air changes in the Storage and Laundry rooms is much higher than in the larger zones.

A small aberration in the flow may be noticed around the large step up and step down of the flow at 9:15 A.M. on the 24th and 10:45 A.M. on the 25th. Such an artifact is caused by the fact that the flow is changing faster than the time constant of the analysis (i.e. 30 minutes) which can cause a bias in the flow estimate. Around midnight another

artifact can be observed. This artifact was caused by a variation in the instrument calibration induced by the pump oils; subsequent use of an oil trap eliminated the problem.

Occupied House

In January of 1988 MTMS was transported to Olympia Washington for use in a two-story, single-family residence. The house is made up of three zones; three bedrooms combined for the first zone, the kitchen, dining room and living room with a cathedral ceiling taken together as another zone, and the lower story consisting of a study and family room for the third zone. These have floor areas of 66, 57, and 69 m² with corresponding volumes of 151, 165, and 158 m³. The house has a central forced-air heat pump, and was built around 1980. The leakage area of the house was measured at 1150 cm², with leakage in the HVAC duct system being 150 cm² of the total. The flow in the HVAC ducts was measured at 2100 m³/h while the heat pump was off and the fan forced on. The flow is lower than this when the heat pump is on. There is a night setback of about 5 degrees which operates from 11 P.M. to 6 A.M.. Usually the bedroom doors are closed at 11 PM and the bedroom window may be opened. At any time the door between the downstairs and living zones may be partly closed.

The period selected for display was typical of the ten-day period of monitoring: the building was conditioned and there was routine occupancy. Although the injection and sampling locations were necessarily less centrally located than in the unoccupied house, the normal use of the central heating system assisted in sufficiently mixing the tracers. The small mixing fans installed were often turned off by the residents and were not always turned back on.

Figure 3 is a plot of the measured air flows on January 15. The measurement time constant is half an hour. Figure 3a shows the flows from outside to all the other zones; figure 3b shows the flows from the Bedroom zone to all the other zones; figure 3c shows the flows from the Living/Kitchen zone to all the other zones; figure 3d shows the flows from the Family/Study zone to all the other zones. Some trends are evident in these plots: the family awakes at about 6 AM and opens the bedroom doors and the heating system comes on as the setback period is over. Although confounded by these effects, a trend towards larger stack effect during the night may be inferred from the data.

The data in figure 3 may be somewhat biased (See refs. 9,10) if the furnace fan operation induces significant zonal air flows; such behavior may be visible in figure. 3. The data was then reanalyzed with a much shorter time constant and the results are shown in figure 4. In this figure it is apparent that furnace operation has a significant effect on the zonal air flows; the pattern of cycling can be easily seen in all of the flows during the day. During the night, however, the slow furnace cycling (because of thermostat set-back), the low activity level and the closed internal doors make the data too noisy to pick up trends with such a short time constant.

It is apparent that many of the flows are increased with fan operation. Since there are more supply than return registers, it is not surprising that the interzonal flows are increased when the fan is running. However, it is also apparent that the flows to and from outside are increased with fan operation; and thus, operation of the HVAC system increases total infiltration.

The bias caused by a longer averaging time is apparent when comparing figures 3 and 4 for those flows having a large oscillating component. The flows in figure 3 while smoother are significantly lower.

DISCUSSION

The focus of the MTMS development has been to create a portable system capable of measuring the ventilation between different zones of a multiple zone building, and then use that system to 1) understand the physical processes associated with ventilation 2) provide the capability of validating ventilation models 3) measure real-time air flows for diagnostic purposes. The focus of this report is to describe the MultiTracer Measurement System.

Although the datasets provided herein are intended as examples, some inferences can be drawn. Because the data is recorded at short intervals, MTMS has the ability to respond quickly to changes in the air flows. Such quick response is especially important in the inter-zonal flows (cf. flows to outside) as they can change quickly in response to occupancy or the HVAC system. For pollutant transport concerns these interzonal flows may be more important than the outside air infiltration.

The data from the occupied house analyzed over 10 minutes clearly shows that the operation of a central, forced air system makes significant changes in the both the inter-zonal flows and in the infiltration into each zone. It is clear that the pressure in each zone is significantly different when the fans are running. Although in an individual zone this could either increase or decrease the infiltration into that zone, the total air infiltration into the building increases as a result of the differential pressurization. Furthermore leakage between the ductwork and outside can also be responsible for increased infiltration. It is not possible from the data presented to ascertain how much of the excess infiltration can be attributed to each cause.

Comparison of the data analyzed with the two different time constant indicates the magnitude of the bias which can be introduced if too long an averaging time is used in the analysis. Users of passive ventilation techniques must be aware—especially in multizone environment—that the use of long-term averaged concentration readings may give inappropriate, or even unphysical, results for flows which have a strong time dependence.

The MultiTracer Measurement System is a tool which can answer many questions regarding ventilation in complex building environments. This report has demonstrated some of its capabilities and we anticipate future research efforts will make use of them. Ongoing efforts include the use of MTMS data to validate single-zone infiltration models (i.e. the LBL Infiltration Model) and multizone ventilation models (i.e. COMIS),¹³ as well as to understand the influences that forced air systems have on residential ventilation rates. In all we anticipated that MTMS will provide a useful tool for understand multizone ventilation in buildings.

ACKNOWLEDGEMENTS

The authors would like to acknowledge Issac Amarel of the Rafael-Armament Development Authority, Isreal for is invaluable assistance in the development and calibration of the RGA hardware during his sabbatical year at LBL.

REFERENCES

1. P.H. Singer, "Helium Leak Detection in Vacuum Systems and IC Packages", *Semiconductors International* **10 (11)**, pp. 51-5 (1987)
2. R., McCullough, "Leak Testing", *ASTM Standardization News*, **10 (11)**, pp. 32-3 (1982)
3. Ferber, G.J., Telegadas, K., Heffter, J.L., et al., "Demonstrations of a Long-Range Atmospheric Tracer System Using Perfluorocarbons," BNL-33846, Brookhaven National Laboratory, (1983)
4. Lagus P., Persily, A.K., "A Review of Tracer Gas Techniques for Measuring Airflows in Buildings," *ASHRAE Transaction* **91(IIB)** p1075-1087, (1985)
5. Harrje, D.T., Dutt, G.S., Bohac, D.L., "Documenting Air Movements and Infiltration in Multicell Buildings Using Various Tracer-gas Techniques," *ASHRAE Transaction* , **91(II)** (1985).
6. Bryson, A.E. and Ho, Y., *Applied Optimal Control*, Hemisphere Publ., Washington D.C. 1975
7. Tarantola, Albert, *Inverse Problem Theory*, Elsevier, New York, (1987)
8. Sherman, M.H., "Uncertainty in Air Flow Calculations Using Tracer Gas Meas-

urements," In Press *Building and Environment*.

9. Sherman, M.H., "Analysis of Errors Associated with the Passive Ventilation Measurement Technique," *Bldg. & Environ.*
Lawrence Berkeley Laboratory Report LBL-23088 (1988)
10. Sherman, M.H., "On Estimation of Multizone Ventilation Rates from Tracer-gas Measurements" To be Published *Building and Environment*.
11. Harrje, Dietz, Sherman, Bohac, Ottavio, Dickerhoff, "Tracer Gas Measurement Systems Compared in Multifamily and Commercial Buildings", To be publ. *Special Technical Publication* American Society for Testing and Materials, Atlanta, GA
12. Hubbard, L.M., Bolker, B., Socolow, R.H., Dickerhoff, D., "Radon Dynamics in a House Heated Alternately by Forced Air and by Electrical Resistance", Proceedings of the USEPA 1988 Symposium on Radon and Radon Reduction Technology, October 18-21, 1988, Denver, Colorado.
13. The Conjunction Of Multizone Infiltration Specialists (COMIS) being held at LBL is a joint international effort involving 8 different countries.

NOMENCLATURE

C	Instantaneous tracer gas concentration [kg/m^3]
C_e	Estimated tracer gas concentration [kg/m^3]
C_{ex}	Extrapolated tracer gas concentration [kg/m^3]
C_m	Measured tracer gas concentration [kg/m^3]
C_t	Target tracer gas concentration [kg/m^3]
κ	Feedback gain for (Kalman) filtering [-]
N	Number of zones [-]
Q	Ventilation [m^3/h]
Q_e	Estimated Ventilation [m^3/h]
S	Instantaneous source strength of tracer gas [m^3/h]
t	Time [h]
δt	Time difference between measurements [h]
τ_i	Integral time constant [h]
τ_p	Proportional time constant [h]
V	Volume [m^3]
σ	Standard deviation of an air flow [m^3/h]
i, j, k	indices indicating zone [0, 1 \dots N]
X	(bold) indicates matrix of (X) values

FIGURES CAPTIONS

- 1 Layout of the MultiTracer Measurement System (MTMS).
- 2 Air flows from unoccupied house starting on December 24. 2a shows the flows to the Bedroom; 2b shows the flows to the Living room; 2c shows the flows to the Storage room; 2d shows the flows to the Laundry room.
- 3 Air flows from occupied house on January 15 with a 30 minute analysis time. 3a shows the flows from outside; 3b shows the flows from the Bedroom zone; 3c shows the flows from the Living/Kitchen zone; 3d shows the flows from the Family/Study zone.
- 4 Air flows from occupied house on January 15 with a 10 minute analysis time. 4a shows the flows from outside; 4b shows the flows from the Bedroom zone; 4c shows the flows from the Living/Kitchen zone; 4d shows the flows from the Family/Study zone.

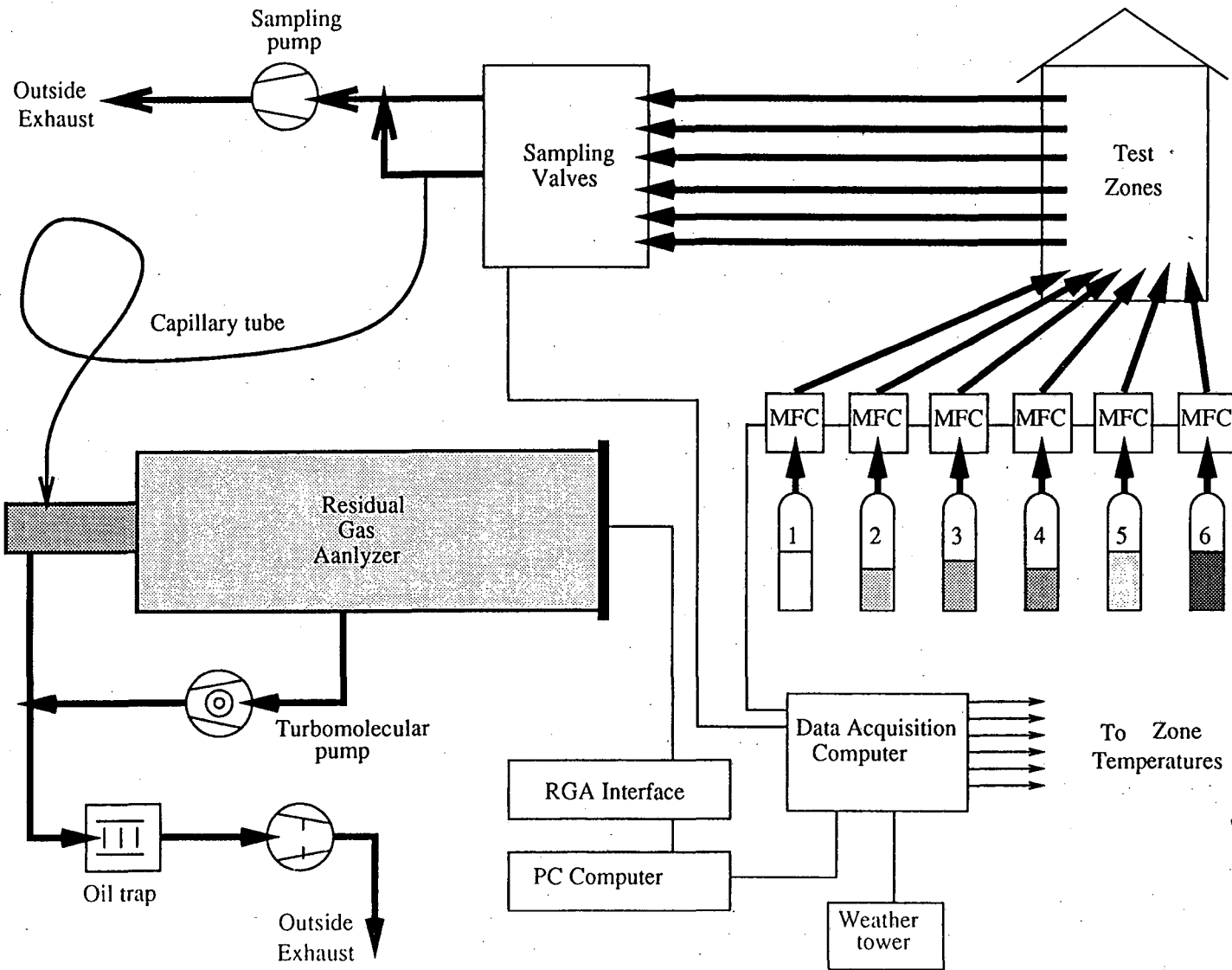

XBL 894-1298

Figure 1

Flows To Bedroom Volume = 61 m³

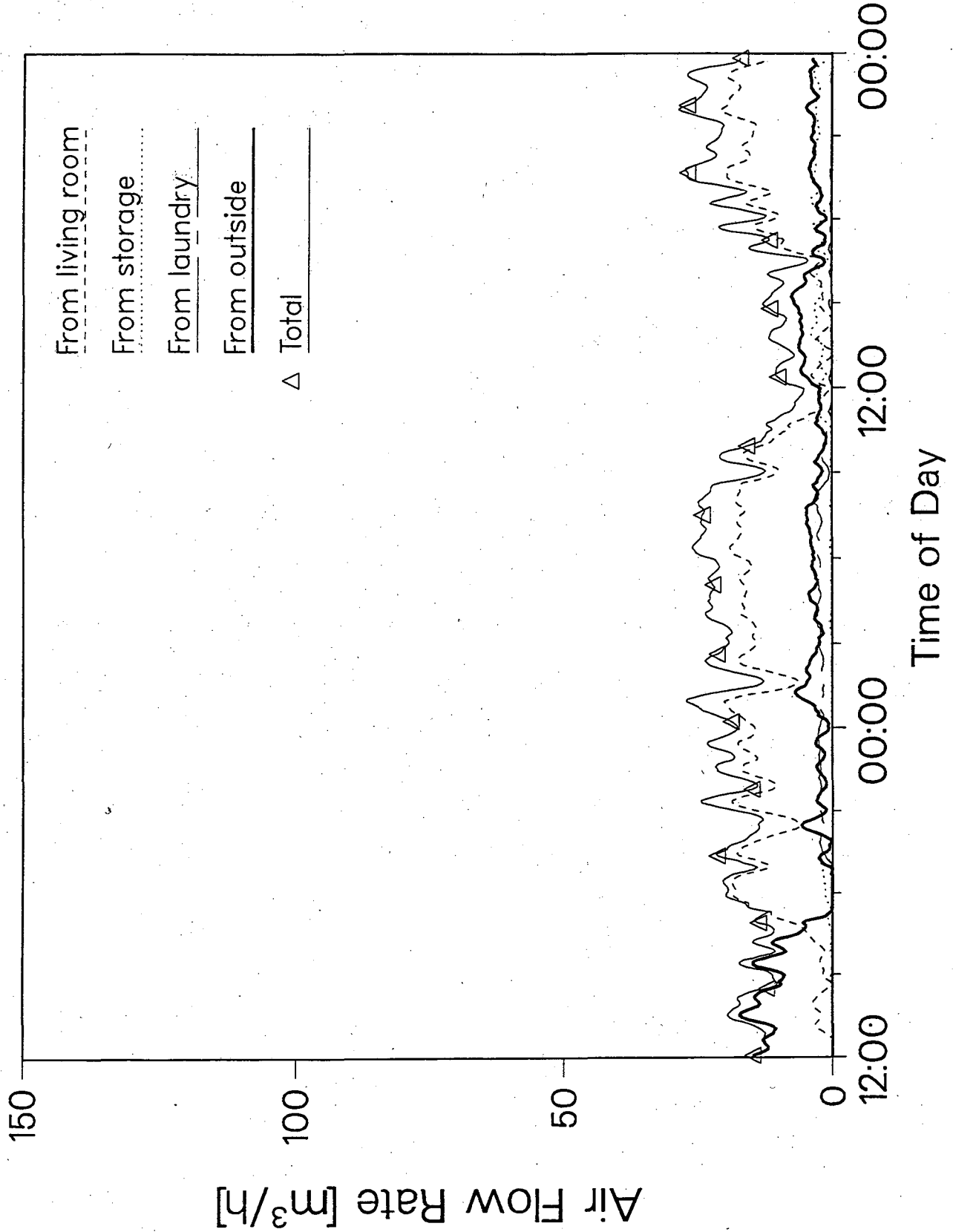

Figure 2a

Flows To Living Room Volume = 243 m³

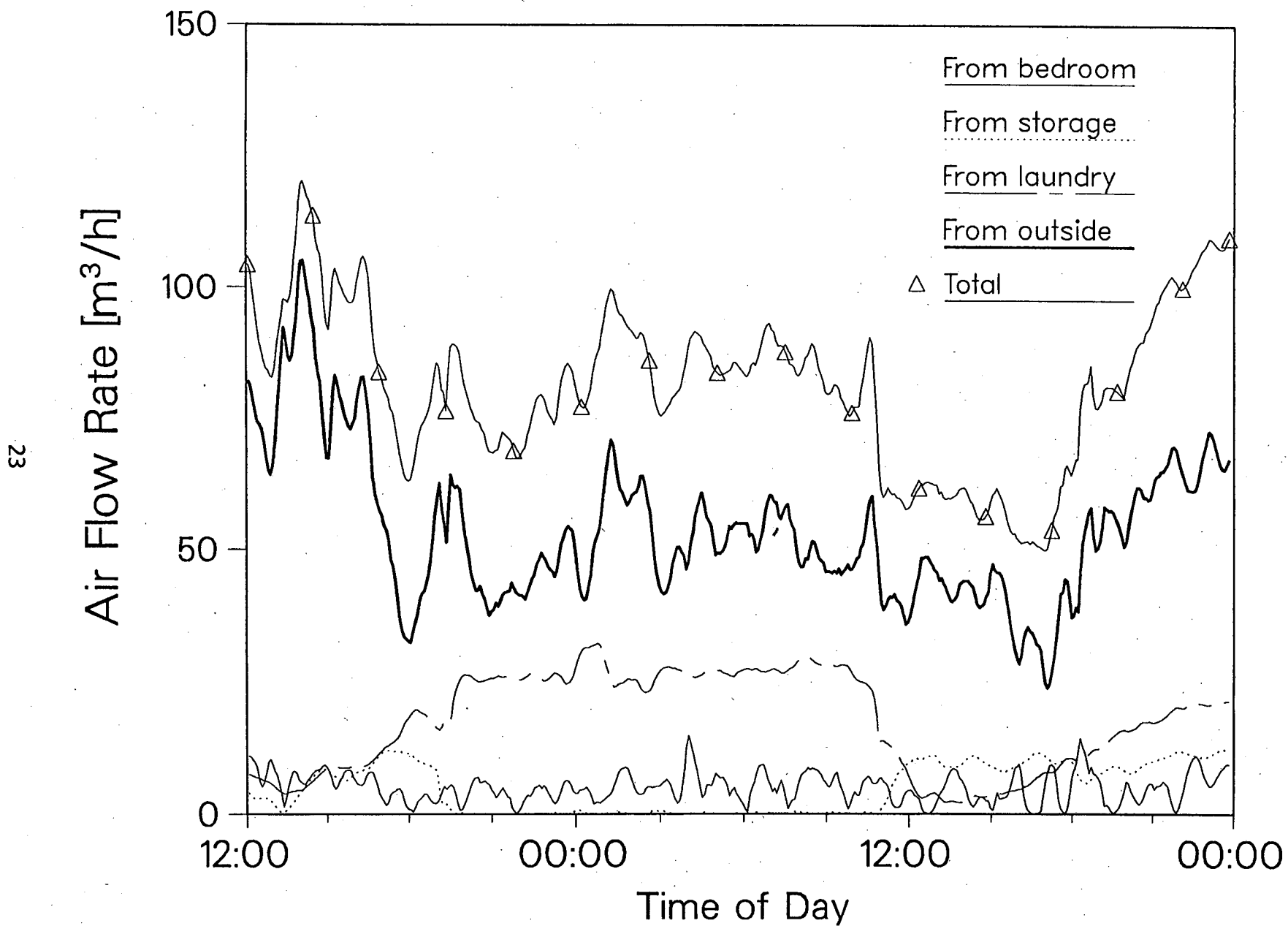

Figure 2b

Flows To Storage Room Volume = 60 m³

24

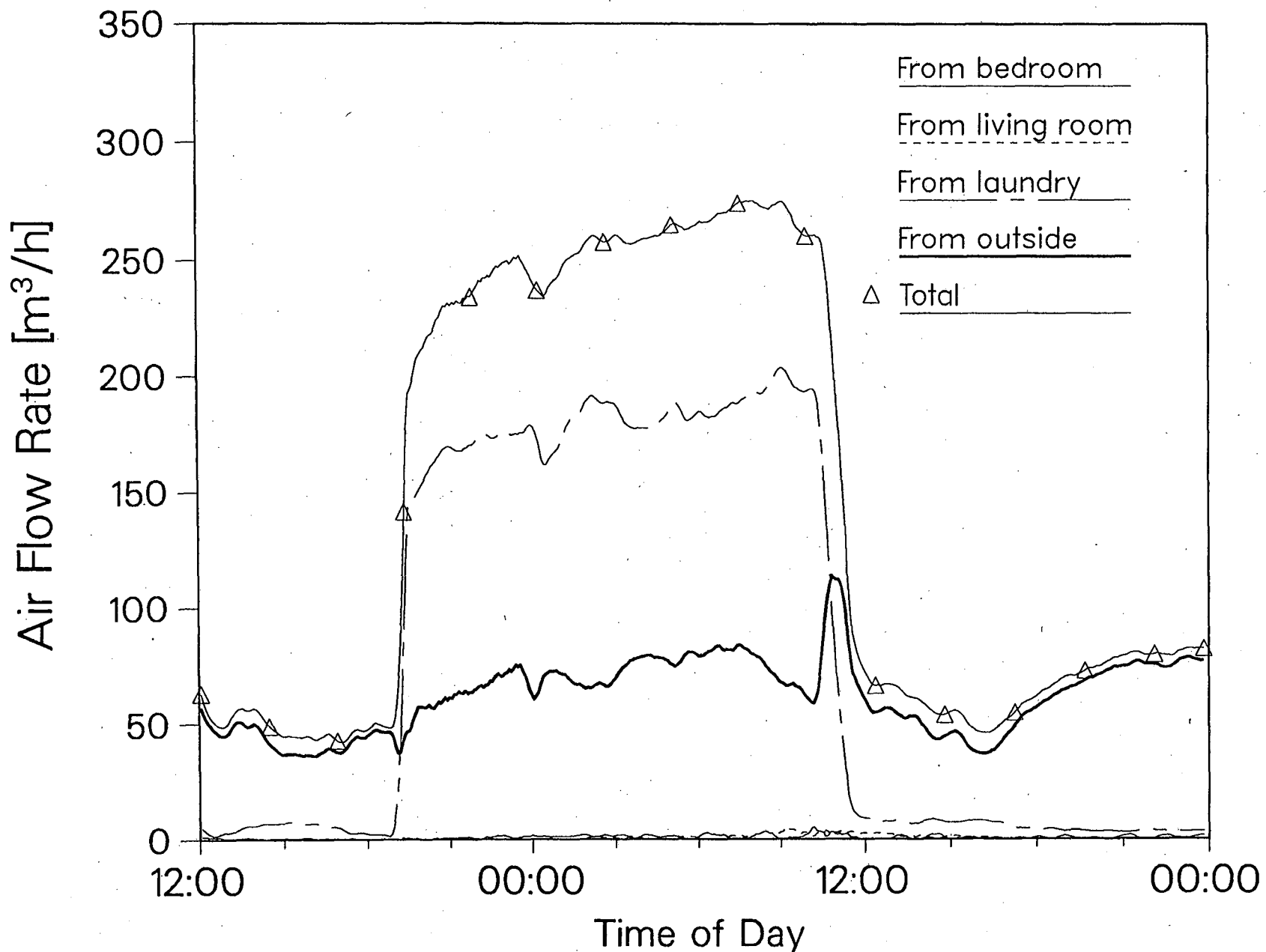

Figure 2c

Flows To Laundry Room Volume = 30 m³

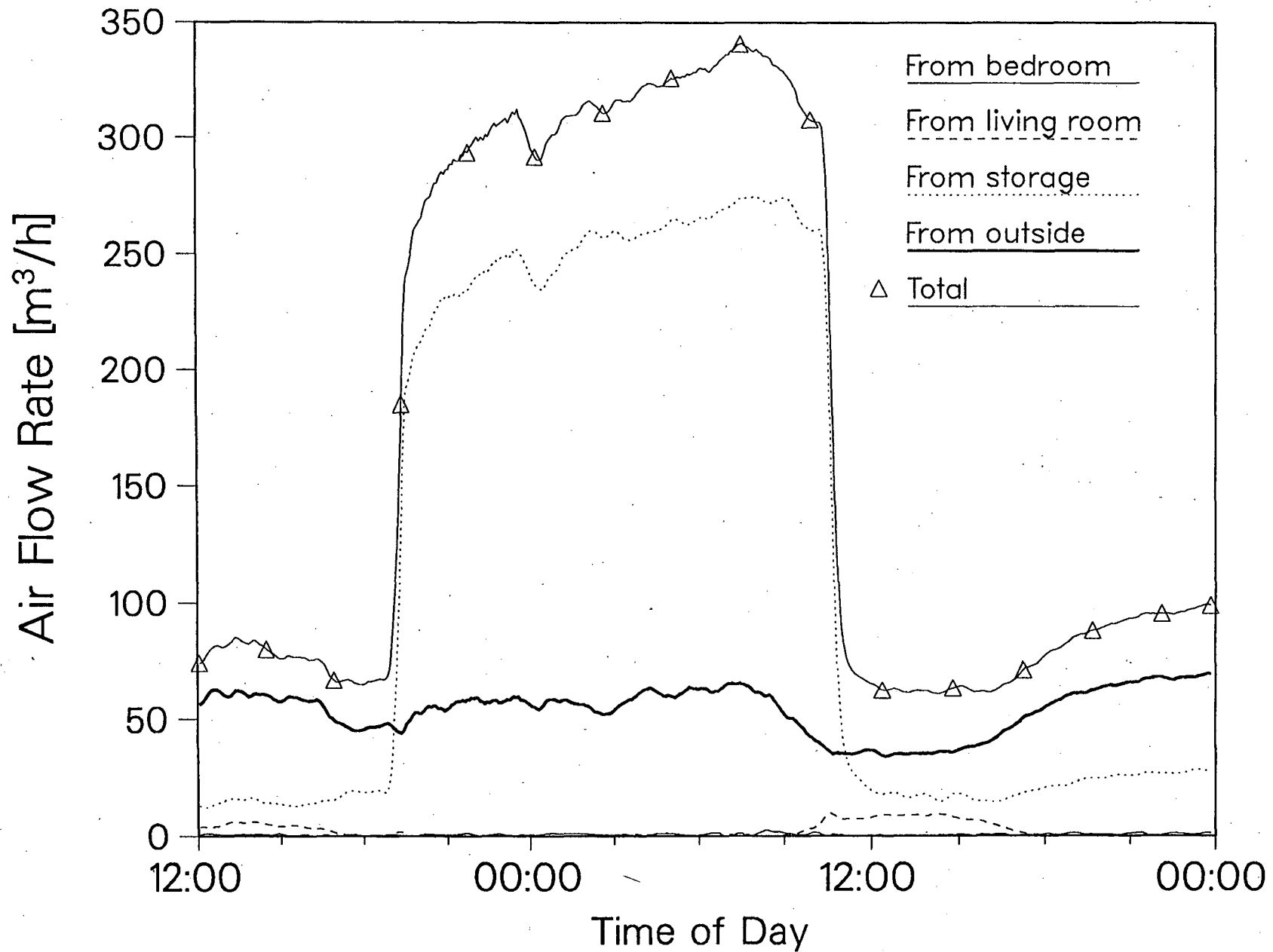

Figure 2d

Flows From Outside House Volume = 473 m³

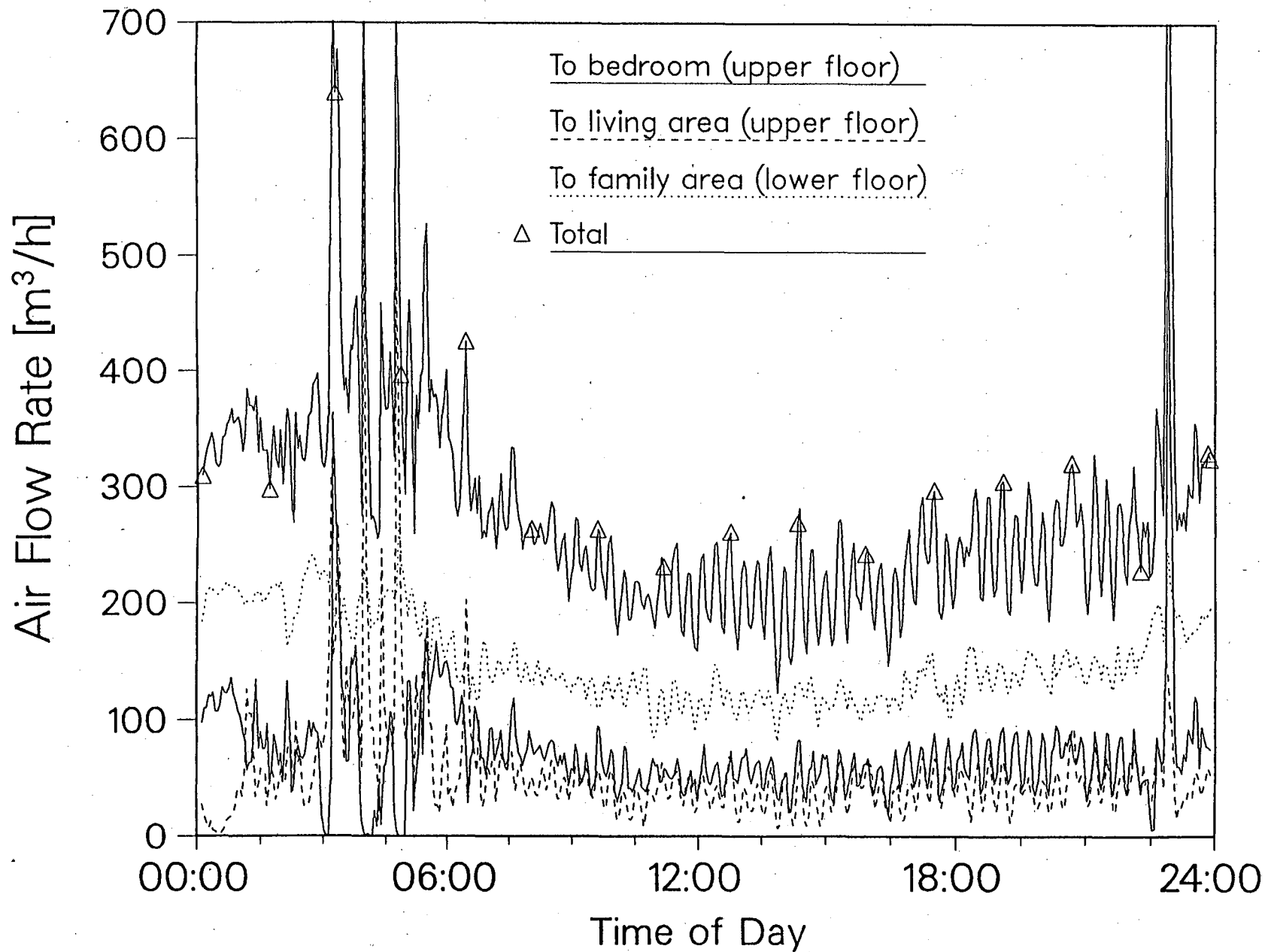
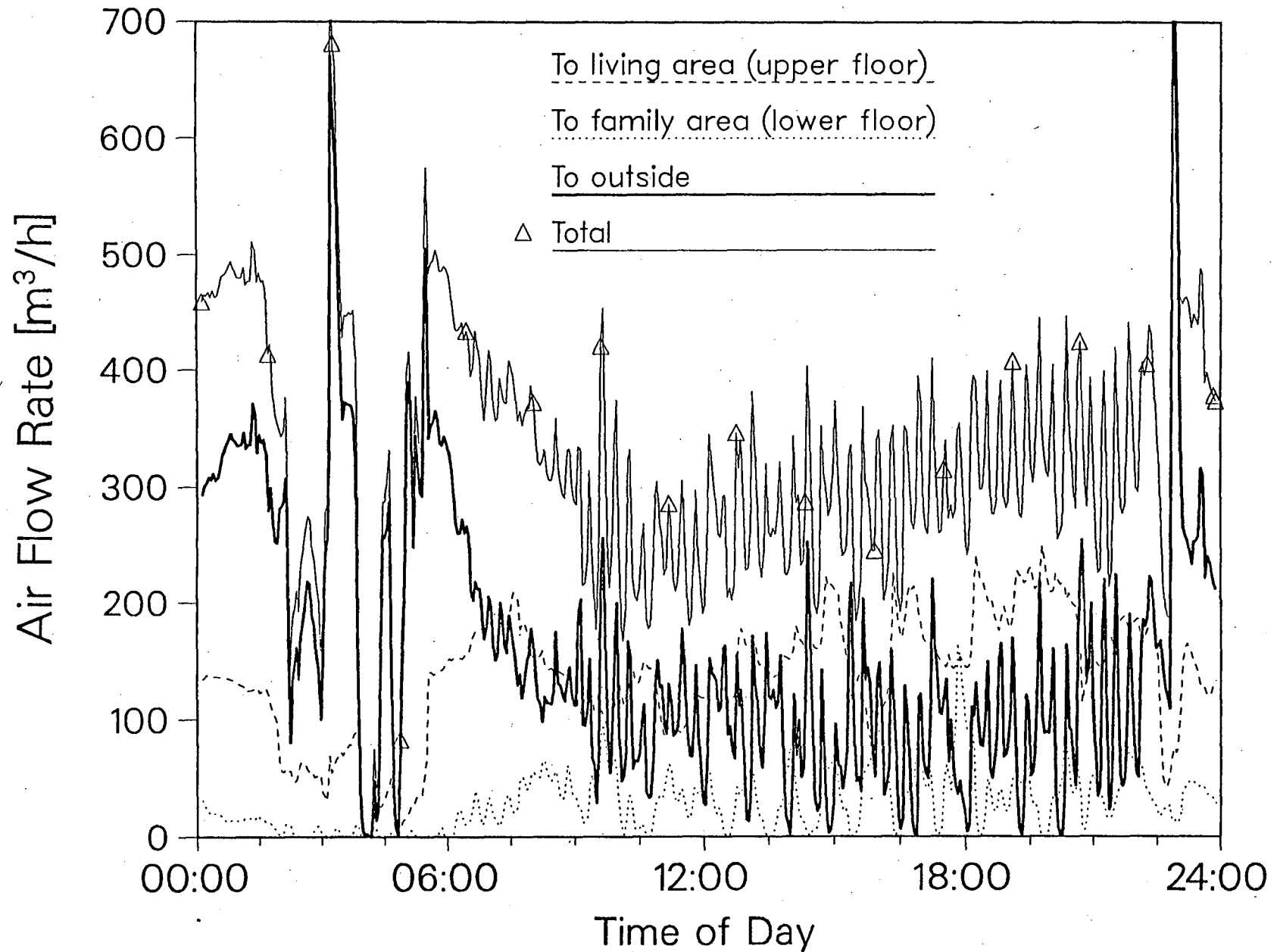

Figure 3a

Flows From Bedroom (upper floor) Volume = 150 m³



Flows From Living Area (upper floor) Volume = 165 m³

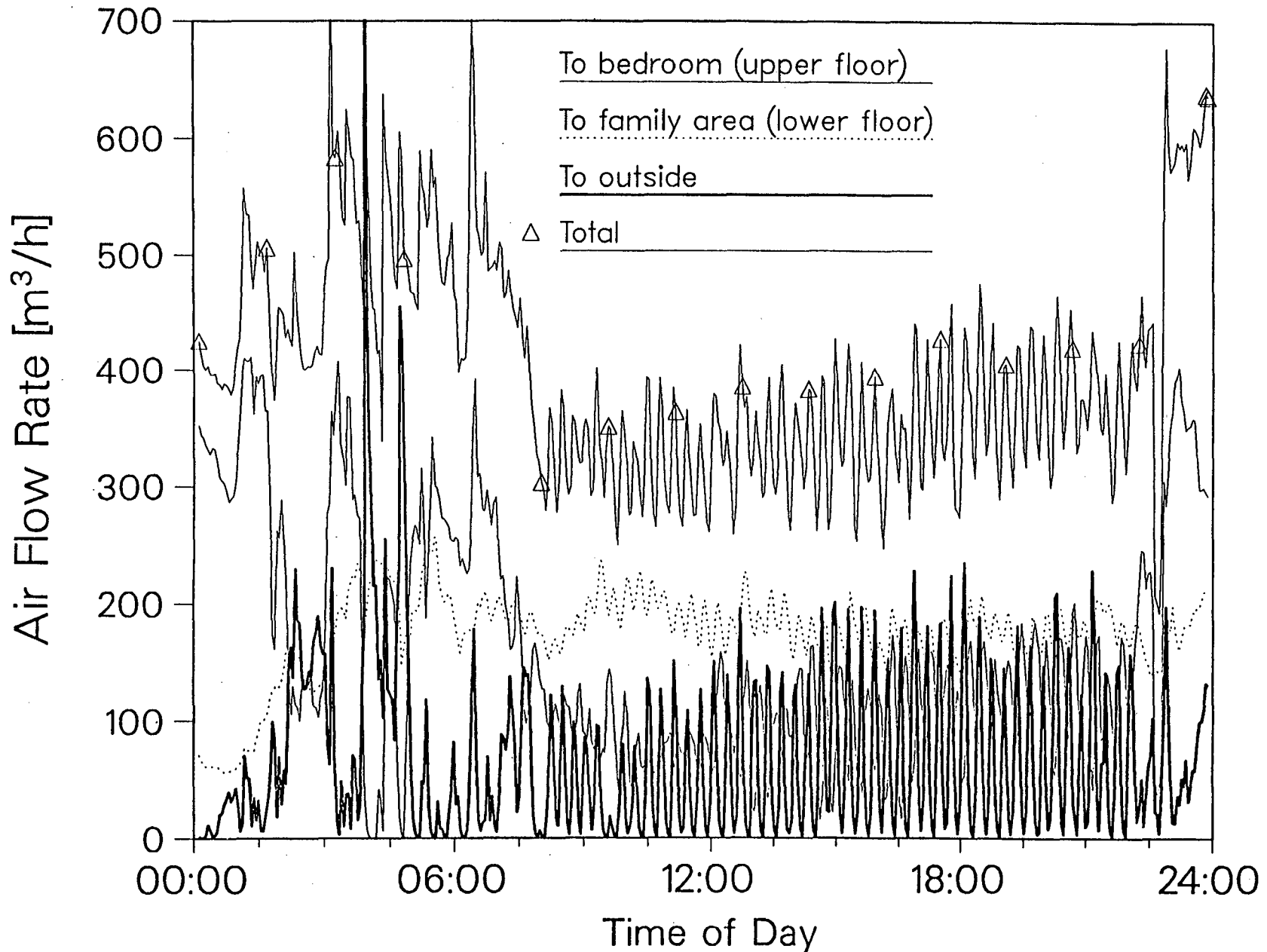

Figure 3c

Flows From Family Area (lower floor) Volume = 157 m³

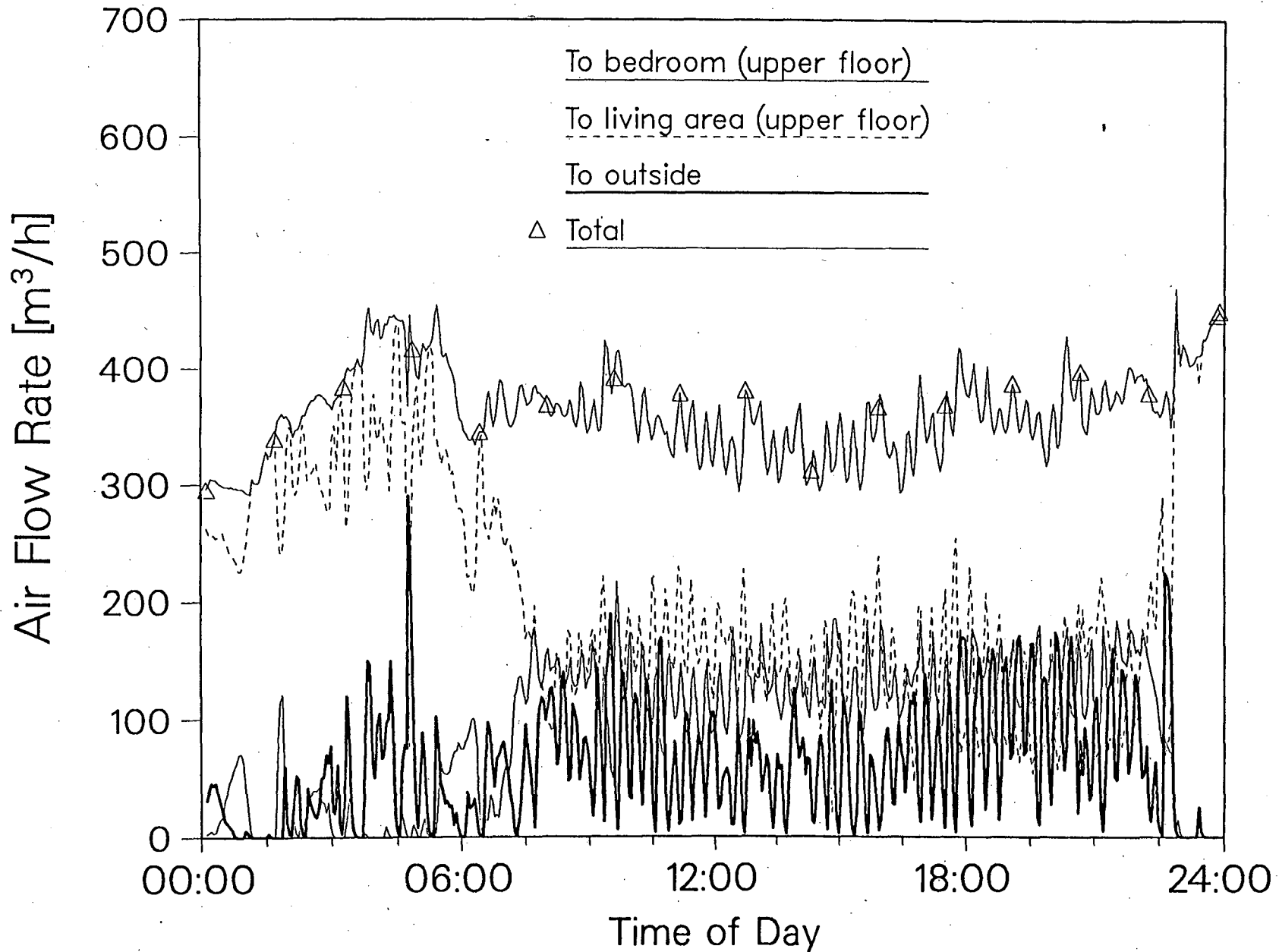

Figure 3d

Flows From Outside House Volume = 473 m³

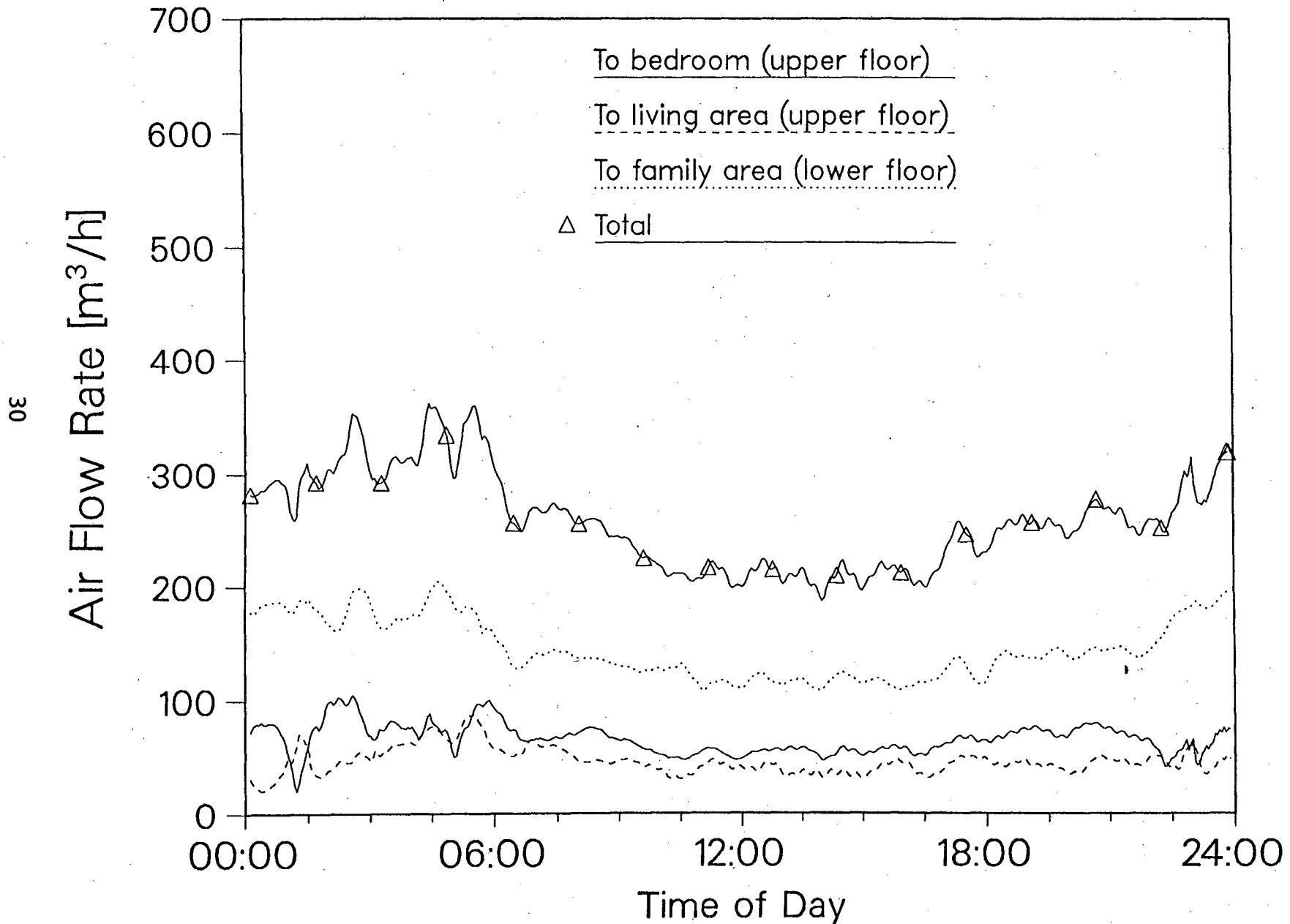

Figure 4a

Flows From Bedroom (upper floor) Volume = 150 m³

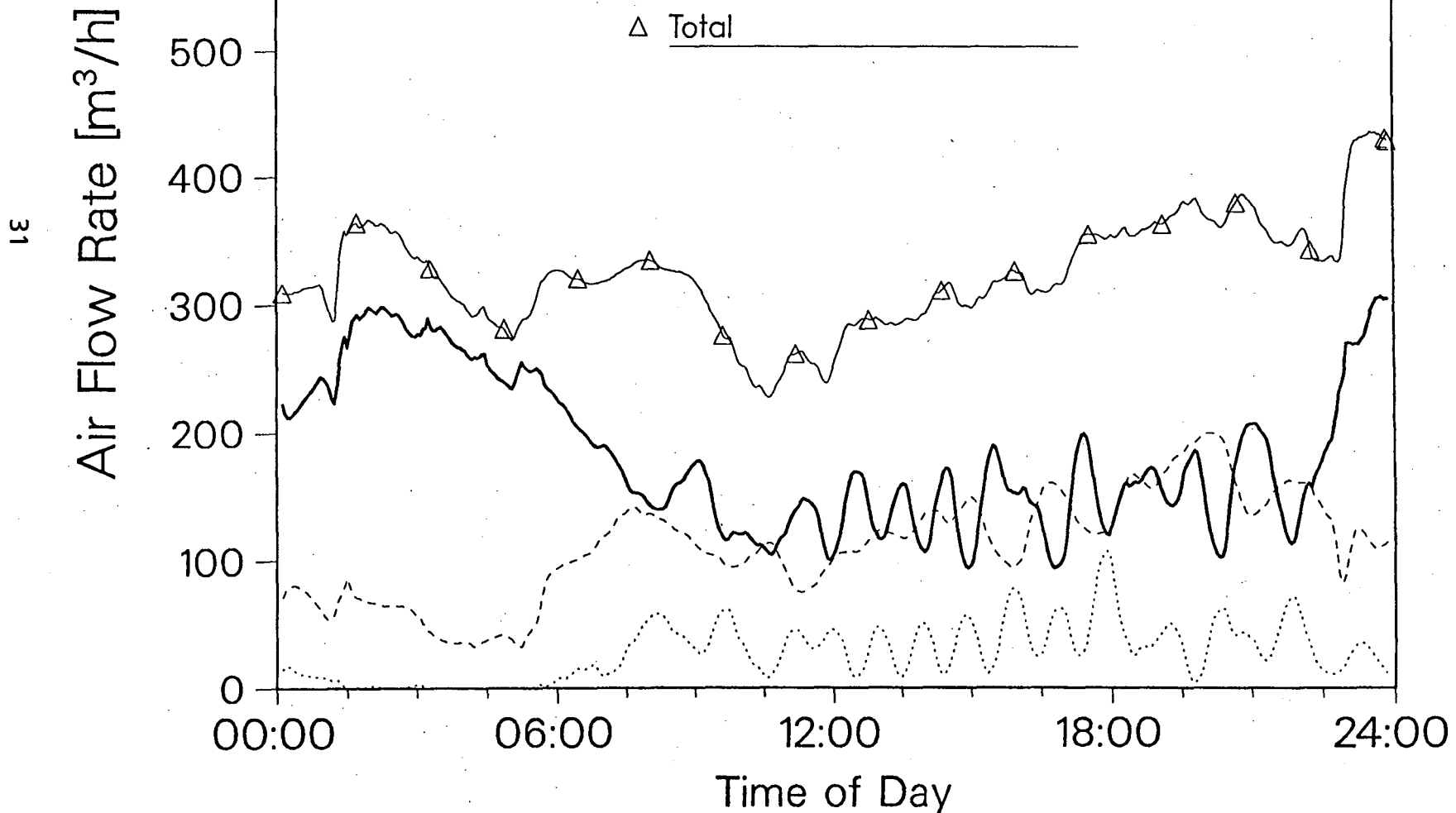

Figure 4b

Flows From Living Area (upper floor) Volume = 165 m³

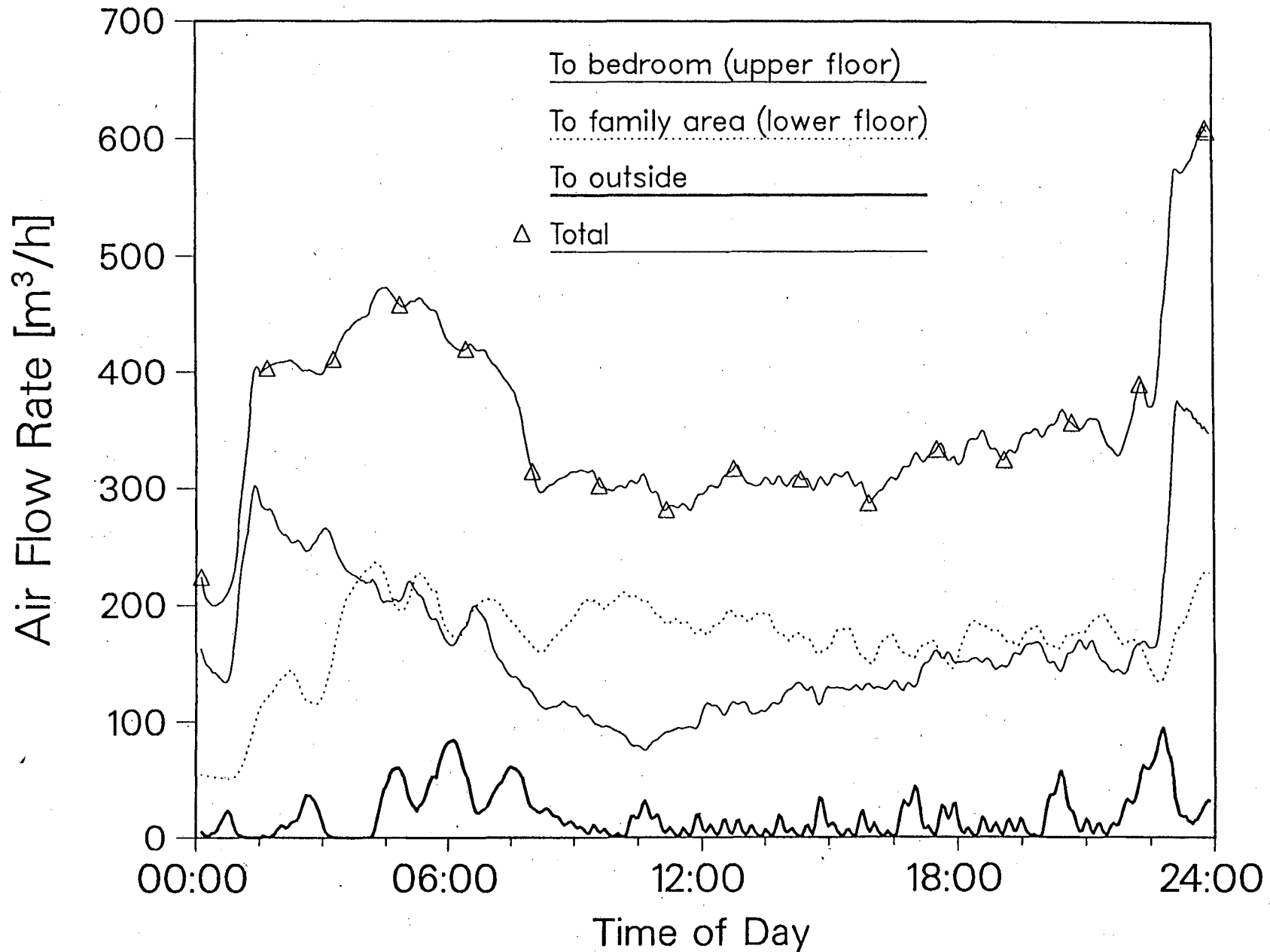

Figure 4c

Flows From Family Area (lower floor) Volume = 157 m³

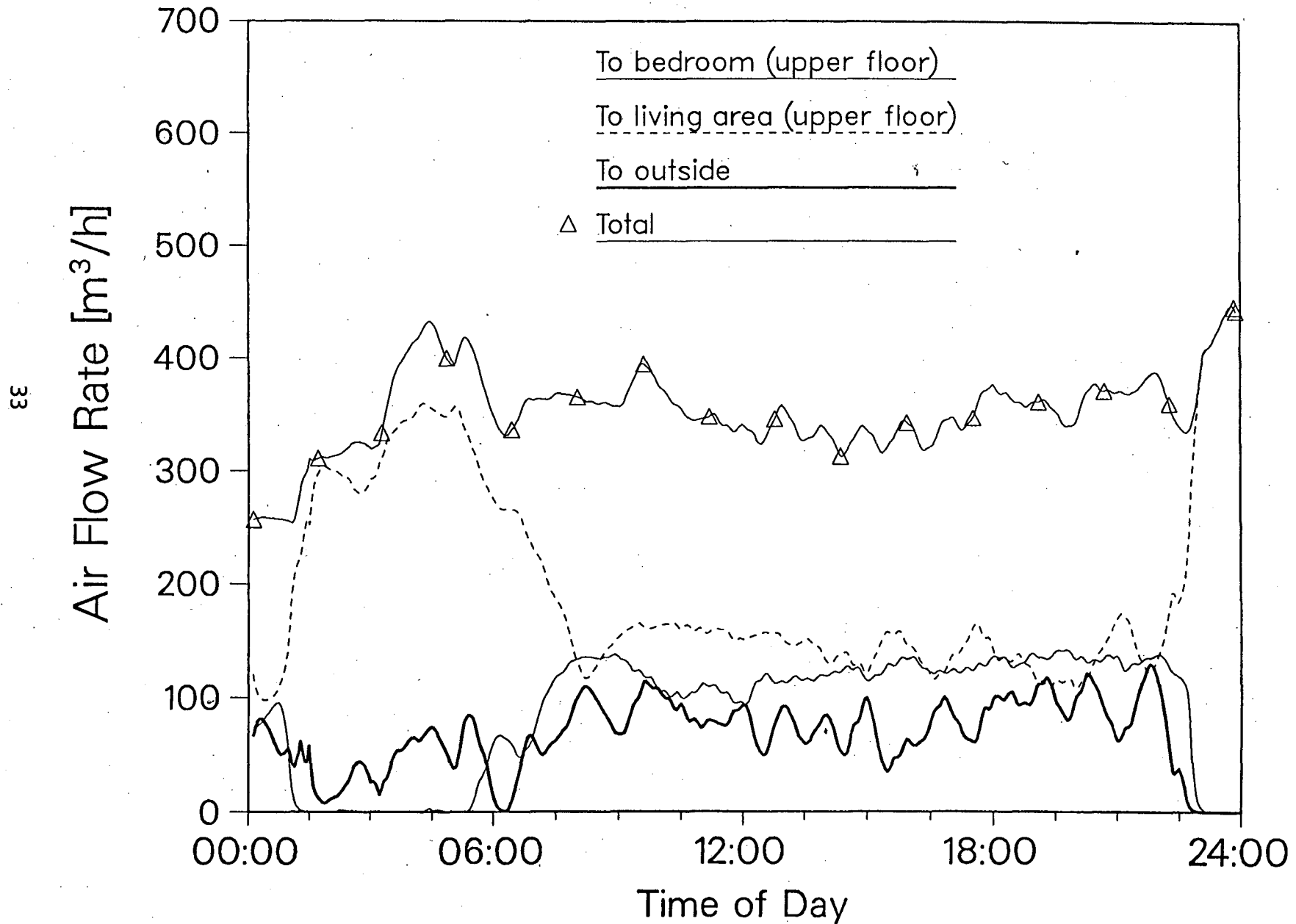

Figure 4d

LAWRENCE BERKELEY LABORATORY
UNIVERSITY OF CALIFORNIA
TECHNICAL INFORMATION DEPARTMENT
BERKELEY, CALIFORNIA 94720