

ERNEST ORLANDO LAWRENCE
BERKELEY NATIONAL LABORATORY

International Best Practices for Pre-Processing and Co-Processing Municipal Solid Waste and Sewage Sludge in the Cement Industry

Ali Hasanbeigi, Hongyou Lu, Christopher Williams, Lynn Price
China Energy Group
Energy Analysis and Environmental Impacts Department
Environmental Energy Technologies Division
Lawrence Berkeley National Laboratory

July 2012

This work was supported by the U.S. Environmental Protection Agency and the Institute for Industrial Productivity through the U.S. Department of Energy under Contract No. DE-AC02-05CH11231.

Disclaimer

This document was prepared as an account of work sponsored by the United States Government. While this document is believed to contain correct information, neither the United States Government nor any agency thereof, nor The Regents of the University of California, nor any of their employees, makes any warranty, express or implied, or assumes any legal responsibility for the accuracy, completeness, or usefulness of any information, apparatus, product, or process disclosed, or represents that its use would not infringe privately owned rights. Reference herein to any specific commercial product, process, or service by its trade name, trademark, manufacturer, or otherwise, does not necessarily constitute or imply its endorsement, recommendation, or favoring by the United States Government or any agency thereof, or The Regents of the University of California. The views and opinions of authors expressed herein do not necessarily state or reflect those of the United States Government or any agency thereof, or The Regents of the University of California.

Ernest Orlando Lawrence Berkeley National Laboratory is an equal opportunity employer.

International Best Practices for Pre-Processing and Co-Processing Municipal Solid Waste and Sewage Sludge in the Cement Industry

Ali Hasanbeigi, Hongyou Lu, Christopher Williams, Lynn Price

China Energy Group, Energy Analysis and Environmental Impacts Department
Environmental Energy Technologies Division
Lawrence Berkeley National Laboratory

Abstract

Co-processing municipal solid waste (MSW) and sewage sludge in cement kilns can both reduce the cement industry's growing fossil fuel use and carbon dioxide (CO₂) emissions and help address the increasing need for safe and environmentally sensitive municipal waste treatment and disposal.

The cement industry accounts for approximately 5 percent of current anthropogenic CO₂ emissions worldwide. Given increasing cement demand and production, the industry's absolute energy use and CO₂ emissions will continue to grow. Cement kilns typically burn fossil fuels, which are non-renewable and being depleted rapidly. Treating wastes in cement kilns, known as co-processing, can reduce the industry's reliance on fossil fuels and decrease associated CO₂ emissions. The ashes from waste co-processing will be integrated into the clinker which can result in saving the virgin raw materials. In addition, treating wastes in cement production can help alleviate the problems associated with the increase in waste generation around the world, especially in developing countries experiencing rapid urbanization. Municipalities and governments in many urban areas, especially those with underdeveloped waste management systems, face growing difficulties disposing of MSW and sewage sludge in a manner that protects human and environmental health.

The high temperatures and sufficiently long residence time in cement kilns and other characteristics of cement production make co-processing of waste materials a viable strategy. Wastes have been co-processed in cement kilns for more than 20 years, and this practice is prevalent in some developed countries such as the United States and Japan, as well as in a number of countries in the European Union. Many developing countries such as China and nations in Southeast Asia are initiating programs to promote co-processing of wastes in the cement industry. Regulations, standards, and the technical infrastructure in these developing countries are less mature than in countries that have a long experience with co-processing waste in the cement industry.

The purpose of this report is to describe international best practices for pre-processing and co-processing of MSW and sewage sludge in cement plants, for the benefit of countries that wish to develop co-processing capacity. The report is divided into three main sections. Section 2 describes the fundamentals of

co-processing, Section 3 describes exemplary international regulatory and institutional frameworks for co-processing, and Section 4 describes international best practices related to the technological aspects of co-processing.

Contents

Abstract	i
1. Introduction.....	1
1.1. Municipal Solid Waste.....	1
1.2. Sewage Sludge	3
1.3. Co-processing: Part of the Solution	3
2. Fundamentals of Co-processing Municipal Solid Waste and Sewage Sludge in the Cement Industry	4
2.1. Cement Production	4
2.1.1. CO ₂ Impacts of Cement Production	4
2.2. Co-processing of MSW and Sewage Sludge in the Cement Industry.....	5
2.3. Reasons and Motivations for Co-processing of MSW and Sewage Sludge.....	9
2.4. Impacts of Co-processing on Cement and Concrete Quality	13
2.5. Tradeoffs between Energy Use and Waste Co-processing	14
2.6. Economics of Waste Co-processing	15
2.7. Health and Environmental Risks of Co-processing	17
2.8. Key Barriers to Co-processing	18
3. Legal, Regulatory, and Institutional Frameworks for Co-processing: International Best Practices	20
3.1. General Legal Frameworks.....	20
3.1.1. European Union.....	21
3.1.2. United States	24
3.1.3. Japan	26
3.2. Regulations and Standards.....	26
3.2.1. Environmental performance requirements.....	26
3.2.2. Product quality requirements.....	34
3.2.3. Waste quality requirements	35
3.2.5. Safety and health requirements	37
3.3. Institutional Frameworks	38
3.3.1. Waste collection and management.....	38
3.4. Permitting and Performance Approval	43
3.5. Monitoring System Requirements	48
3.6. Enforcement of Regulations	50
4. Technological Aspects of Co-processing – International Best Practices	52
4.1. Pre-processing Technologies and Practices	52
4.1.1. Pre-processing technologies and practices for MSW	52
4.1.2. Pre-processing technologies and practices for sewage sludge	61
4.2. Storage, handling, and feeding systems	69
4.2.1. Storage.....	70
4.2.2. Handling and conveyors	70
4.2.3. Feeding and dosing systems	71
4.3. Co-processing of MSW and Sewage Sludge in the Cement Kiln	73
4.3.1. Selection of feed point for alternative fuels.....	73

4.3.2. Multi-fuel burners.....	75
4.3.3. Additional kiln system improvements/retrofits for co-processing	76
4.4. Product Quality Control Systems	79
4.5. Emissions and Air Pollution.....	80
4.5.1. Impact of co-processing on kiln emissions	80
4.5.2. Emissions Control Techniques	84
4.5.3. Continuous emissions monitoring system.....	86
4.6. Health and Safety Practices	87
5. Summary.....	90
Acknowledgments.....	91
References.....	92
Appendices.....	102
Appendix 1. Cement Production Processes and Energy Use	102
Appendix 2. Diagram of Reaction Zones for Different Kiln Technologies.....	104
Appendix 3. Example of an Accept-Refuse Chart.....	105
Appendix 4. Performance and Cost of RDF Production Lines	106
Appendix 5. Flow Diagram of Sewage Sludge Pre- and Co-processing Project in Australia	108
Appendix 6. Control Technologies for Gaseous Pollutants from Cement Manufacturing	109
Appendix 7. Recommended Method for Using CEMS to Determine Each Type of Pollutant from a Cement Plant.....	112
Appendix 8. Standards for Cement Plant Emissions Measurements: Sampling and Analyses.....	113
Appendix 9. Short List of Pre- and Co-processing Technology Providers for Alternative Fuels in the Cement Industry.....	114

Acronyms

BAT	best available technique
CaCO ₃	limestone
CaO	lime
CO	carbon monoxide
CO ₂	carbon dioxide
CEMBUREAU	European Cement Association
CEMS	continuous emissions monitoring systems
CISWI	commercial and industrial solid waste incineration
EIPPCB	European Integrated Pollution Prevention and Control Bureau
EPAV	Environmental Protection Authority of Victoria
E-PRTR	European Pollutant Release and Transfer Register
ERT	electronic reporting tool
EU	European Union
GJ	gigajoule
HAP	hazardous air pollutant
HF	hydrogen fluoride
IPPC	Integrated Pollution Prevention and Control
ISO	International Standards Organization
kWh	kilowatt-hour
MACT	maximum achievable control technology
MBT	mechanical biological treatment
µm	micrometer
MSW	municipal solid waste
Mt	million tonnes
NCV	net calorific value
ng	nanogram
Nm	nanometer
NO _x	nitrogen oxide
O ₂	oxygen
NSP	new suspension preheater/precalciner
PAH	polycyclic aromatic hydrocarbon
PCDD	polychlorinated dibenzo-p-dioxin
PCDF	polychlorinated dibenzofuran
POP	persistent organic pollutant
ppm	parts per million
RDF	refuse-derived fuel
SO ₂	sulfur dioxide
t	tonne
TEQ	toxic equivalency basis

U.S. EPA	United States Environmental Protection Agency
VOC	volatile organic compound
WBCSD	World Business Council for Sustainable Development
WFD	Waste Framework Directive
WID	Waste Incineration Directive
WWTP	wastewater treatment plant

1. Introduction

The cement industry relies heavily on fossil fuels and accounts for approximately 5 percent of current anthropogenic carbon dioxide (CO₂) emissions worldwide (WBCSD/IEA 2009a). Cement demand and production are increasing; annual world cement production is expected to grow from approximately 2,540 million tonnes (Mt) in 2006 to between 3,680 Mt (low estimate) and 4,380 Mt (high estimate) in 2050. The largest share of this growth will take place in China, India, and other developing countries on the Asian continent (Figure 1) (WBCSD/IEA 2009b). This significant increase in cement production is associated with a significant increase in the industry's absolute energy use and CO₂ emissions. Use of alternative fuels can help reduce the rapid rate at which fossil fuel resources are being depleted, and, if the alternative fuels have lower CO₂ emission factors or contain biomass, can also reduce the industry's CO₂ emissions.

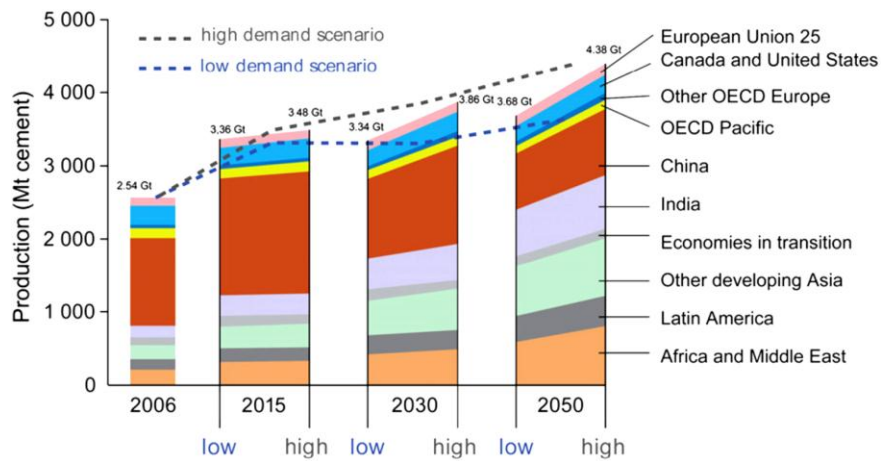

Note: OECD is an acronym for the Organization for Economic Co-operation and Development

Figure 1. Annual world cement production (WBCSD 2009b)

In addition to the energy use and CO₂ emissions challenges facing the cement industry, the problem of increasing waste generation is facing countries around the world. This problem is particularly significant in developing countries where major urbanization is taking place. Municipalities and governments in many countries face problems finding safe and environmentally sensitive means to dispose of growing amounts of municipal solid waste (MSW) and sewage sludge. Finally, the ashes from waste co-processing will be integrated into the clinker which can result in saving the virgin raw materials.

1.1. Municipal Solid Waste

MSW consists of everyday items that people use and then throw away, such as product packaging, furniture, clothing, bottles, food scraps, newspapers, appliances, paint, and batteries (U.S. EPA 2012a). The composition of MSW depends on its sources, the season of the year, and the lifestyles and behaviors of local residents. Raw MSW has a high moisture content, low calorific value, wide range of particle sizes, and high ash content. For these reasons, using raw MSW as fuel is difficult and unattractive. MSW can be

treated in a mechanical treatment plant (MT-plant) or in a mechanical biological treatment plant (MBT-plant). Both treatment methods result in a refuse-derived fuel (RDF) that has a considerable higher heat value than the incoming raw waste. In addition to high calorific value, RDF has the advantages of having a more uniform physical and chemical composition than raw MSW; being easier to store, handle, and transport; emitting fewer pollutants; and requiring less excess air during combustion (Nithikul 2007).

Table 1 shows the amount of MSW generated in a sample of countries around the world. Both total and per capita waste generation have been stable or decreasing in recent years in some developed countries (e.g., in the United States [U.S. EPA 2012a]). However, in some developing countries, these values have been increasing (e.g., in China [NBS 2005-2011]). Furthermore, in developed countries the waste recycling rate is often higher than that in developing countries (Zhanga et al. 2010). Figure 2 shows MSW disposal methods in China in 2006 as an example.

Table 1. MSW generation in sample of countries around the world in 2005 (Zhanga et al. 2010)

Countries	Total amount of MSW generation (1,000 tonnes)	MSW generation rate (kilograms/capita/day)
USA	222,863	2.05
France	33,963	1.48
Germany	49,563	1.64
Denmark	3,900	2.03
Switzerland	4,855	1.78
Poland	9,354	0.68
Portugal	5,009	1.29
Hungary	4,632	1.26
Mexico	36,088	0.93
Japan	51,607	1.10
Korea	18,252	1.04
China (2006)	212,100	0.98

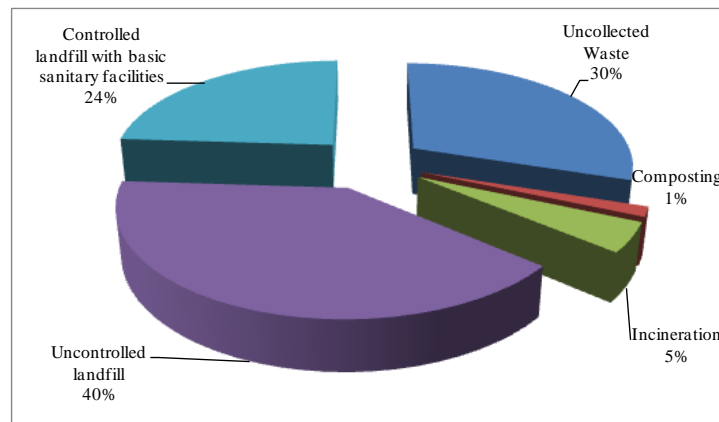

Figure 2. MSW disposal methods in China in 2006 (Zhanga et al. 2010)

1.2. Sewage Sludge

Sewage sludge is generated primarily by municipal wastewater treatment plants (WWTPs). Sewage sludge production has increased substantially in recent years because of an increase in the number and size of urban communities and as well as in the amount of wastewater discharged by industrial processes (He et al. 2007; Milieu Ltd, WRc and RPA 2008).

In the United States in 2007, 16,583 wastewater treatment facilities generated around 6.5 Mt dry sewage sludge (biosolids) (U.S. EPA 2008). Most sewage sludge generated in the United States and other countries is recycled to land or sent to landfills, not incinerated or burned for energy recovery in cement kilns (Milieu Ltd, WRc and RPA 2008).

Sludge that is applied to land must comply with strict human and environmental health standards, and sludge that is contaminated with heavy metals from industrial wastewaters is unfit for use in agriculture (Murray and Price 2008).

Developing countries, such as China and India, are rapidly expanding wastewater treatment facilities, so the quantity of sewage sludge is also rapidly increasing. In 2005, wastewater treatment plants in China generated 9 Mt of dewatered sludge; within 10 years, this amount is expected to increase to 27 Mt (Murray and Price 2008).

1.3. Co-processing: Part of the Solution

Under- or undeveloped waste management remains a problem in developing countries and countries in transition. In many of these countries, waste is discharged to sewers, buried, or burned in an uncontrolled manner, illegally dumped at unsuitable locations, or taken to landfills that do not meet requirements for environmentally sound final disposal of waste. These practices can result in contamination of soil, water resources, and the atmosphere, leading to ongoing deterioration in the living conditions and health of adjacent populations.

Co-processing of selected waste streams in cement kilns could be part of the solution to this problem (GTZ/Holcim 2006). Sewage sludge, which is often land filled or used in agriculture, can be used as an alternative fuel and raw material in the cement clinker manufacturing process. Many European countries have already started adopting this practice for sewage sludge management (CEMBUREAU 2009). Both pre-processed MSW and sewage sludge have relatively high net calorific value (NCV) in gigajoules (GJ) per dry tonne. Pre-processed MSW and sewage sludge also have a much lower CO₂ emissions factor compared to coal when treated in a cement kiln. Table 2 shows the typical characteristics of MSW and sewage sludge used as alternative fuel. However, the energy content of MSW in some developing countries often reported to be even lower than the range shown in Table 2.

**Table 2. Typical characteristics of MSW and sewage sludge used as alternative fuel
(Murray and Price 2008)**

Fuel	Substitution rate (% of fuel)	Energy content (NCV) (GJ/dry t)	Water content (%)	CO ₂ emission factor (ton CO ₂ /t)
Municipal solid waste (RDF fraction)	up to 30	12 - 16	10 - 35	0.95 - 1.32
Dewatered sewage sludge	20	9 - 25	75	0.29
Dried sewage sludge	20	9 - 25	20	0.88

2. Fundamentals of Co-processing Municipal Solid Waste and Sewage Sludge in the Cement Industry

The subsections below describe the cement production process, its CO₂ impacts, and various issues related to co-processing MSW and sewage sludge in the cement industry.

2.1. Cement Production

The general process by which cement is manufactured today entails quarrying and crushing or grinding the raw materials (commonly limestone [CaCO₃], chalk, and clay), which are then combined and passed through a kiln in the form of either a dry powder or a wet slurry. The average raw material temperature in the kiln goes up to 1,450°C. The heat fuses the raw materials into small pellets known as clinker. The cooled clinker is combined with gypsum and ground into the fine powder known as Portland cement. The American Society for Testing and Materials defines several types of Portland cement with different properties as well as several blended hydraulic cements that are made by combining materials such as Portland cement, fly ash, natural pozzolana (a siliceous volcanic ash), artificial pozzolana, and blast furnace slag (PCA 2012). The European Union has similar classifications for cements incorporating alternative cementitious material. Appendix 1 describes the process by which cement is produced in more detail, with a focus on the energy use in cement production processes.

2.1.1. CO₂ Impacts of Cement Production

Producing 1 metric ton (t) of cement releases an estimated 0.73 to 0.99 t CO₂ depending on the clinker-per-cement ratio and other factors. A major difference between the cement industry and most other industries is that fuel consumption is not the dominant driver of CO₂ emissions. More than 50 percent of the CO₂ released during cement manufacture, or approximately 540 kilograms (kg) CO₂ per t of clinker (WBCSD 2009), is from calcination, in which CaCO₃ is transformed into lime (CaO) in the following reaction:

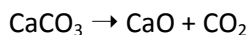

The rest of the CO₂ emitted during cement manufacture is the result of burning fuel to provide the thermal energy necessary for calcination. Kilns in which calcination takes place are heated to around 1,450°C. An average 100 to 110 kilowatt hours (kWh) of electricity is consumed per t of cement (WWF 2008). The share of CO₂ emissions from electricity use is, on average, 5 percent of the total CO₂ emissions

in the cement industry. Depending on the energy source and the efficiency with which it is used in the local electricity mix, this figure can vary from less than 1 percent to more than 10 percent. Roughly 5 percent of CO₂ emissions are associated with quarry mining and transportation (WWF 2008).

2.2. Co-processing of MSW and Sewage Sludge in the Cement Industry

The Basel Convention (2011) defines co-processing as “the use of waste materials in manufacturing processes for the purpose of energy and/or resource recovery and resultant reduction in the use of conventional fuels and/or raw materials through substitution.” This is also a concept in industrial ecology, related to the potential role of industry in reducing environmental burdens throughout a product’s life-cycle. The Basel Convention further defines co-processing as an operation “which may lead to resource recovery, recycling, reclamation, direct reuse or alternative uses” (Basel Convention 2011).

Waste co-processing has been practiced for more than 20 years, especially in developed countries/regions such as Europe, Japan, the United States, and Canada (GTZ/Holcim 2006; Genon and Brizio 2008). Figure 3 shows the quantities of waste co-processed in the European cement industry in 2003 and 2004. In 2006, alternative fuels other than scrap tires and solvents (e.g., MSW and sewage sludge) collectively represented about 2.5 percent of the total energy input to U.S. cement kilns (EPA, 2008). In 2009, 63 cement plants, or 70 percent of all cement plants in the United States, used alternative fuels (PCA, 2012).

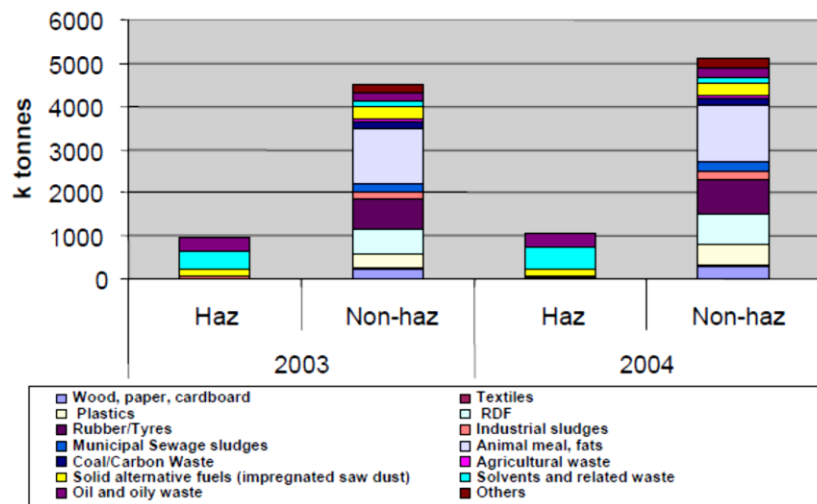

Figure 3. Co-processing of hazardous and nonhazardous waste in cement kilns in the European Union in 2003 and 2004 (EIPPCB 2010)

The European Integrated Pollution Prevention and Control Bureau (EIPPCB) (2010) identifies the following characteristics of cement production that allow for the co-processing of waste materials:

- Maximum temperatures of approximately 2,000°C (main firing system, flame temperature) in rotary kilns
- Gas retention times of about 8 seconds at temperatures greater than 1,200°C in rotary kilns

- Material temperatures of about 1,450°C in the sintering zone of the rotary kiln
- Oxidizing gas atmosphere in the rotary kiln
- Gas retention time in the secondary firing system of more than 2 seconds at temperatures greater than 850°C; in the precalciner, correspondingly longer retention times and higher temperatures
- Solids temperatures of 850°C in the secondary firing system and/or the calciner
- Uniform burnout conditions for load fluctuations because of high temperatures and sufficiently long retention times
- Destruction of organic pollutants because of high temperatures and sufficiently long retention times
- Sorption of gaseous components like hydrogen fluoride (HF), hydrogen chloride (HCl), and sulfur dioxide (SO₂) on alkaline reactants
- High retention capacity for particle-bound heavy metals
- Short exhaust-gas retention times in the temperature range known to lead to de-novosynthesis of dioxins and furans
- Complete utilization of burnt waste ashes as clinker components
- No product-specific wastes because materials are completely incorporated into the clinker matrix (some European cement plants dispose of bypass dust)
- Chemical-mineralogical incorporation of nonvolatile heavy metals into the clinker matrix

Table 3 shows temperatures and residence times during cement production. Figure 4 shows the temperature profile at different points in a rotary kiln with suspension preheater and precalciner.

Table 3. Temperatures and residence times during cement production (GTZ/Holcim 2006)

Characteristics	Value
Temperature at main burner	>1450°C: material >1800°C: flame temperature.
Residence time at main burner	>12-15 sec > 1200°C >5-6 sec > 1800°C
Temperature at precalciner	> 850°C: material >1000°C: flame temperature
Residence time at precalciner	> 2 - 6 sec > 800°C
Residence time at precalciner	> 2 - 6 sec > 800°C

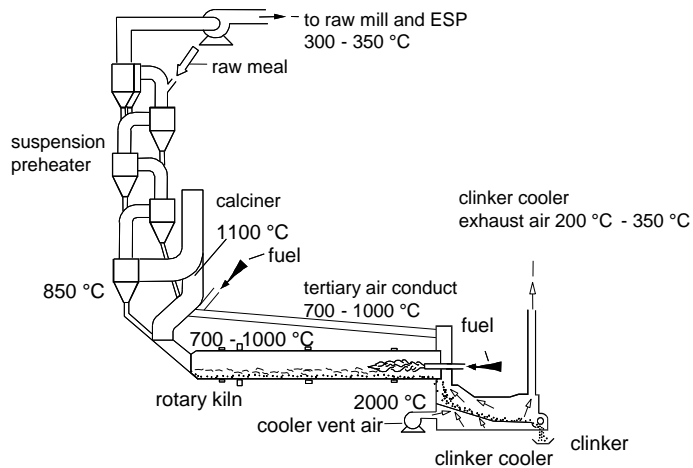

Figure 4. Typical temperature profile of a rotary kiln with suspension preheater and calciner (Schneider et al. 1996)

Not all waste materials are suitable for co-processing in the cement industry. When wastes are selected for co-processing, several factors must be considered, including the chemical composition of both the wastes and the final product (cement) and the environmental impact of co-processing. Examples of wastes that are not suitable for co-processing in the cement industry are waste from nuclear industry, infectious medical waste, entire batteries, and untreated mixed municipal waste. GTZ/Holcim (2006) gives a full list of waste materials suitable for co-processing. Appendix 3 shows an example of a decision chart for accepting or refusing waste for co-processing (CEMBUREAU 2009).

GTZ/Holcim (2006) outlines five general principles that must be followed when co-processing waste in the cement industry. Table 4 shows these principles.

**Table 4. General principles for the co-processing of waste in the cement industry
(GTZ/Holcim 2006)**

Principle 1	<p>Co-processing must respect the waste hierarchy (see Figure 5):</p> <ul style="list-style-type: none"> • Co-processing should not hamper waste reduction efforts, and waste must not be used in cement kilns if ecologically and economically better methods of recovery are available. • Co-processing should be regarded as an integrated part of modern waste management, as it provides an environmentally sound resource recovery option for the management of wastes. • Co-processing must be consistent with relevant international environmental agreements, i.e., the Basel and Stockholm Conventions.
Principle 2	<p>Additional emissions and negative impacts on human health must be avoided:</p> <ul style="list-style-type: none"> • To prevent or keep to an absolute minimum the negative effects of pollution on human and environmental health, emissions to the air shall not be greater, on a statistical basis, than those from cement production using traditional fuel.
Principle 3	<p>The quality of the cement product should remain unchanged:</p> <ul style="list-style-type: none"> • The product (clinker, cement, concrete) must not be abused as a sink for heavy metals. • The product should not have any negative impact on the environment as demonstrated with leaching tests, for example. • The quality of the cement must allow end-of-life recovery.
Principle 4	<p>Companies engaged in co-processing must be qualified:</p> <ul style="list-style-type: none"> • Companies must have good environmental and safety compliance track records and provide relevant information to the public and the appropriate authorities. • Companies must have personnel, processes, and systems demonstrating commitment to the protection of the environment, health and safety. • Companies must comply with all applicable laws, rules and regulations. • Companies must be capable of controlling inputs and process parameters for effective co-processing of waste materials. • Companies must ensure good relations with the public and other actors in local, national, and international waste management schemes.
Principle 5	<p>Implementation of co-processing has to consider national circumstances:</p> <ul style="list-style-type: none"> • Regulations and procedures must reflect country-specific requirements and needs. • Stepwise implementation allows for the buildup of required capacity and the creation of institutional arrangements. • Introduction of co-processing should go along with other improvements in a country's waste management sector.

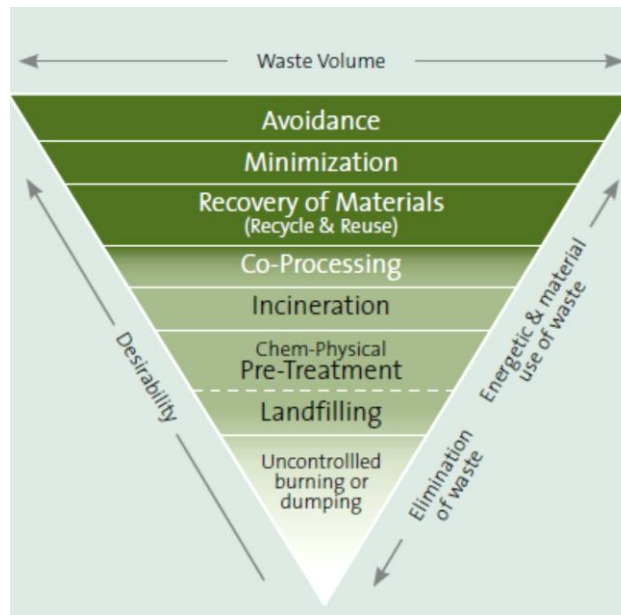

Figure 5. Waste management hierarchy (GTZ/Holcim 2006)

2.3. Reasons and Motivations for Co-processing of MSW and Sewage Sludge

Cement manufacturers around the world are using MSW, sewage sludge, and other alternative fuels to replace fossil fuels. Industrialized countries have more than 20 years of successful experience with co-processing of wastes in cement production (GTZ/Holcim 2006). The Netherlands and Switzerland, which use 83 percent and 48 percent waste, respectively, in the cement fuelstock, are among the world leaders in this practice (WBCSD 2005). In a U.S. Environmental Protection Agency (U.S. EPA) study (2008), many U.S. cement plants indicated that use of alternative fuels is important to their continued competitiveness. Co-processing MSW and sewage sludge in cement kilns has multiple benefits in addition to waste management, as explained in the subsections below.

Saving fuel costs, especially in times of rising fuel prices:

Cement plant operators are understandably concerned about future fuel costs in view of the current upward cost trend. Energy normally accounts for 30 to 40 percent of operating costs in cement manufacturing; any opportunity to save on these costs will make a plant more competitive and maintain or increase its profit margin. Costs vary with the type of waste and local conditions, while often cement plants are paid to treat waste materials; in other cases, the waste may be acquired for free or at much lower cost than the equivalent energy in coal or other fossil fuels (Murray and Price 2008).

MSW and sewage sludge must be pre-processed before being used in a cement kiln, and additional environmental equipment might also be needed to control emissions. Special control and process measures may also be needed to maintain safety, quality, and environmental standards (WBCSD 2002). The lower cost of waste fuels might offset the entire or partial cost of installing the new pre-processing and other equipment, depending on plant-specific conditions. The economics of waste co-processing as

well as the technological aspects of pre- and co-processing are discussed in Section 2.6 and Section 4, respectively, of this report.

Conserving nonrenewable fossil fuels and protecting the environment:

Co-processing of MSW and sewage sludge can replace a significant amount of fossil fuel in the cement industry, conserving nonrenewable fossil fuel resources (Karstensen 2007a). Extraction of fossil fuels, such as coal, often has a significant negative impact on the landscape. To the extent that co-processing of wastes in kilns reduces the need for coal, damage to the land from coal mining can be significantly reduced.

Reducing greenhouse gas emissions:

As noted earlier, the cement industry produces approximately 5 percent of global anthropogenic CO₂ emissions worldwide. Energy-related emissions account for approximately half of this total, with about 40 percent resulting from burning of fuel and the other 10 percent resulting from electricity use and transport (WBCSD 2005). Figure 6 shows the historical and projected CO₂ emissions by the cement industry worldwide through the year 2050. Based on this figure as well as Figure 1, it is clear that the absolute CO₂ emissions of the global cement industry will increase significantly.

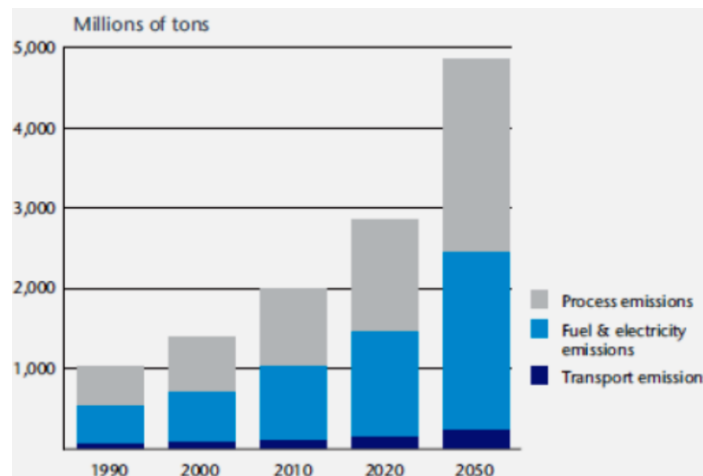

Figure 6. Historical and projected CO₂ emissions of the global cement industry (Campisano 2011)

As can be seen from Table 2 above, both MSW and sewage sludge has significantly lower carbon emission factors than coal. Therefore, replacing coal, which is the most common fuel used in the cement industry, with MSW and sewage sludge will significantly reduce CO₂ emissions. Co-processing of RDF is reported to result in a reduction of about 1.6 kilograms (kg) of CO₂ per kg of utilized RDF, compared to combustion of coal (Genon and Brizio 2008). In 2006, waste co-processing in the European cement industry resulted in an approximately 18 percent reduction in conventional fuel (mostly coal) use, a reduction of about 8Mt of CO₂ emissions each year, and a savings of about 5Mt of coal (CEMBUREAU 2009).

Avoiding negative impacts of waste incineration and landfilling:

In developed countries, MSW is often incinerated, with or without heat recovery, to reduce the need for landfills. The United States has 86 MSW incineration facilities that process more than 28 million tons of waste per year with an energy-recovery capacity of 2,720 megawatts of power. Approximately 10 percent of the original volume remains as ash after incineration of MSW (U.S. EPA 2012b). In general, the ash contains heavy metals and is frequently categorized as a hazardous waste.

Various studies have shown the advantages of co-processing waste in the cement industry in comparison to incinerating waste. A study by the Netherlands Organization for Applied Science Research used the life-cycle assessment approach to compare the environmental impacts of using waste as an alternative fuel / raw material in the cement industry to the impacts of burning waste in hazardous waste incinerators while recovering electricity and steam. The study concluded that, for the vast majority of environmental impacts, using waste as alternative fuel in the cement industry was better for the environment than treating waste in incinerators (CEMBUREAU 2009).

Another life-cycle assessment analysis by CEMBUREAU showed that, for some MSW (e.g. spent solvent, filter cake, paint residues, and sewage sludge), the cement kiln option outperforms other options such as incineration and recycling. This study showed that co-processing of spent solvent, filter cake, paint residues, and sewage sludge yields more environmental benefits than incinerating these waste streams in waste incinerators. Moreover, the study showed that co-processing of waste plastics and waste oils maximizes the beneficial use of these two waste streams relative to conventional incineration or conversion into recycled goods (CEMBUREAU 1999).

Figure 7 shows graphically how co-processing of waste in cement kilns outperforms incineration or landfilling of waste. In addition to CO₂ emissions reduction benefits, co-processing of waste reduces landfill methane emissions. Landfill emissions consist of about 60 percent methane, a gas with a global warming potential 21 times that of CO₂ (CEMBUREAU 2009).

Dried/dewatered sewage sludge that is landfilled contains a significant amount of carbon that can produce methane (UNFCCC 2010). Co-processing of dried/dewatered sewage sludge in cement kilns can eliminate methane emissions from landfilled sludge. Figure 8 shows an example of the CO₂ balance for co-processing versus landfilling of sewage sludge.

Furthermore, Taruya et al. (2002) show that CO₂ generation decreases by 30 percent when dewatered sludge is injected directly into cement kilns instead of being incinerated at the sewage treatment plant, with the ash used as raw material for cement production.

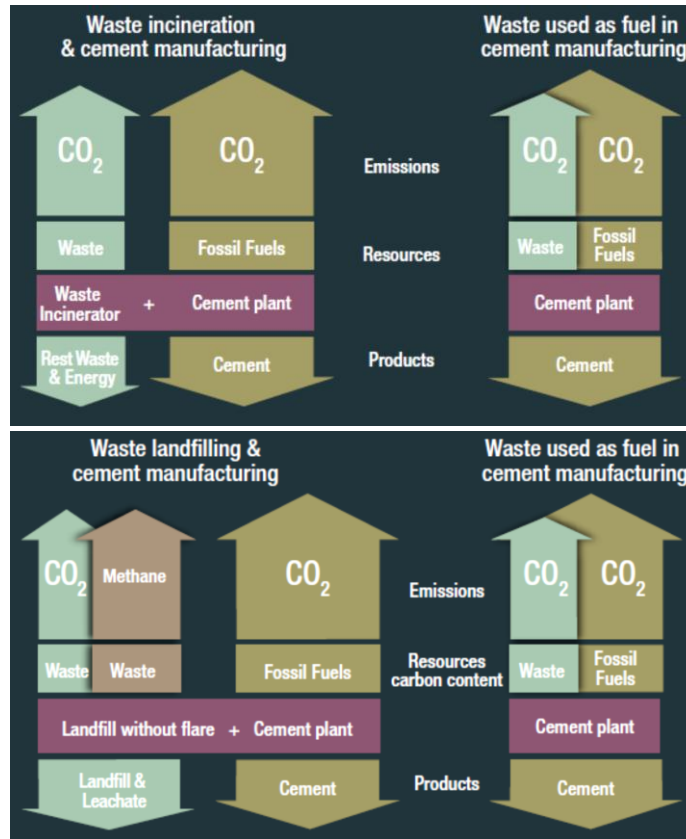
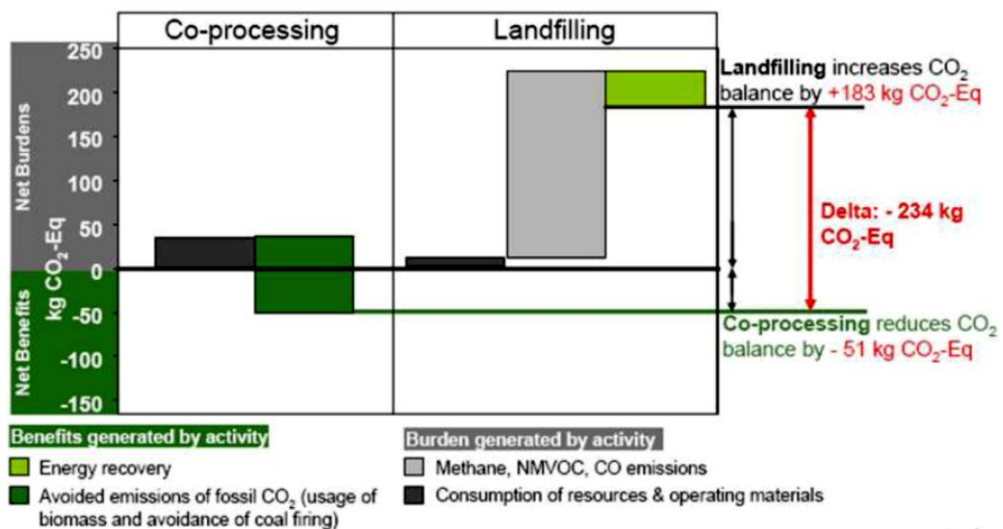

Figure 7. Greenhouse gas emissions from waste landfilling, incineration, and co-processing (CEMBUREAU 2009)



Note: CO₂-Eq: CO₂ Equivalent; NMVOC: non-methane volatile organic compounds

Figure 8. Comparison of CO₂ balance for co-processing and landfilling of 100 kg of sewage sludge (HeidelbergCement 2011)

Integrating waste ash into clinker, which saves raw materials:

The ash from MSW and sewage sludge used in co-processing often has a chemical composition that allows it to be used in place of conventional raw material for clinker making. Figure 9 shows the similar chemical compositions of ash from sludge and of cement raw materials.

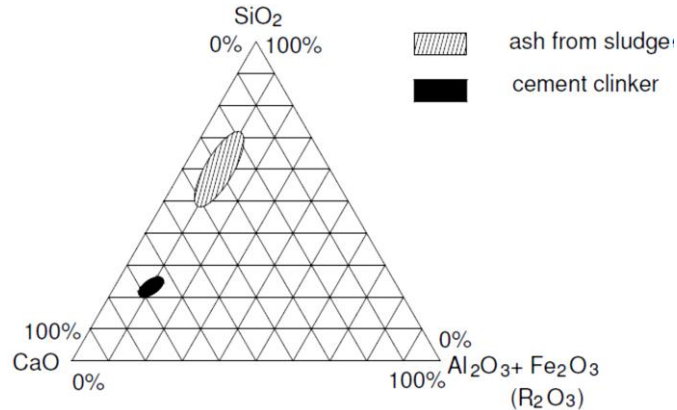

Figure 9. Chemical composition of ash from sludge and cement clinker in ternary diagram: lime (CaO) – silicon dioxide (SiO₂) – refractory oxides (R₂O₃) (Stasta et al. 2006)

In addition, waste materials that do not require significantly more heat to process can contribute part of the CaO needed to make clinker from a source other than CaCO₃, thereby further reducing process-related CO₂ emissions and preserving natural resources (Van Oss 2005).

Avoiding new investment in incinerators or landfill facilities:

Another advantage of co-processing is that municipalities can send waste that cannot be recycled to cement plants for use, rather than having to invest in incinerators or landfill facilities to accommodate the waste (Murray and Price 2008). Co-processing also incorporates ash residues into the clinker so that there are no end products that require further management, such as disposal in a landfill (Basel Convention 2011).

2.4. Impacts of Co-processing on Cement and Concrete Quality

When waste is treated as fuel in cement plants, residues from the waste are incorporated in the clinker and then in cement, which may affect the quality of the final product. For co-processing plants, product quality encompasses two dimensions: whether the residues from the waste fuel pose a potential environmental hazard, e.g., from leaching of the final product, and whether the residues affect the product's technical characteristics and thus its function as a building material. National and international standards address limits on residues in the final product.

The high temperature of cement kilns can completely destroy the organic components in MSW and sewage sludge, but the inorganic components, including metals, are incorporated into the end product. Thus, if there are metals in the MSW and sewage sludge, co-processing of these wastes can change the

metal concentrations in the final product compared to the product that results when the plant is not fueled by wastes (EIPPCB 2010).

Because cement and concrete produced by co-processing must comply with applicable national or international quality standards, it should not be used as a sink for heavy metals or have any characteristics that would result in a negative impact on the environment. In addition, the cement should be of a quality that allows end-of-life recovery (Basel Convention 2011). Studies have shown that, on a statistical basis, waste co-processing has a marginal effect on the heavy metals content of clinker, the one exception being when tires are used as fuel in kilns, which raises zinc levels in the final product. The excessive amount of zinc causes a problem for formation of Portland cement, making it harden too quickly, and therefore need to be managed accordingly (GTZ/Holcim 2006).

The behavior of trace elements in the final product is decisive in evaluating the environmentally relevant impacts of waste co-processing in kilns (CEMBUREAU 2010). Environmental safety can be demonstrated using leaching tests. The results of leaching studies to assess the environmental impacts of heavy metals embedded in concrete showed that the leached amounts of all trace elements from concrete (during service life and recycling) are less than or close to the detection limits of the most sensitive analytical method. However, certain metals, such as arsenic, chromium, vanadium, antimony, and molybdenum, can be more mobile, especially when a mortar or concrete structure is crushed or comminuted (for example, when recycled as aggregate in road foundations or in end-of-life scenarios such as landfilling) (Basel Convention 2011).

2.5. Tradeoffs between Energy Use and Waste Co-processing

Waste co-processing in the cement industry reduces the amount of fossil fuel (e.g., coal) used in the plant and reduces GHG emissions mainly by avoiding the CO₂ and CH₄ emissions from landfilling and/or incinerators (see Figure 7). However, co-processing sometimes increases the overall energy use per tonne of clinker produced by the kiln. This increase could result from a number of factors, mainly the moisture content in the waste which results in additional fan electricity required for extra exhaust gas handling and bypass operation. Table 5 and Figure 10 illustrate an example of the tradeoff and show a breakdown of the extra heat consumed in co-processing.

Table 5. An example of tradeoff between energy use and waste co-processing (Hand 2007)

Item	Plant A	Plant B	Difference
	Using only fossil fuel	Using both fossil fuel and waste fuel ^a (with extra equipment for co-processing)	
Specific heat demand	2.96 GJ/t clinker ^c	3.27 GJ/t clinker	10% ^b
Specific exhaust gas amount	1.4 Nm ³ /kg clinker	1.6 Nm ³ /kg clinker	14%
Pressure drop at fan inlet	- 47 mbar ^d	- 68 mbar	45% ^e

a The type or the share of waste fuel was not provided in the reference.

b See Figure 10 for breakdown of this extra energy use.

c The specific heat demand of 2.96 GJ/t clinker for Plant A is on the very low side of the range and would be attained by a very efficient dry kiln running for a certain period, under very stable conditions, with the right raw materials, etc. However, it would be usually hardly achieved by a kiln, over a year period. The same point would apply to Plant B with co-processing of wastes.

d mbar: millibar

e The pressure drop could be associated with other factors and not only the co-processing of waste. For example, plant B shows a secondary combustion chamber which will require additional pressure drop. While the use of secondary combustion chamber is useful, it is not necessarily a requirement for co-processing.

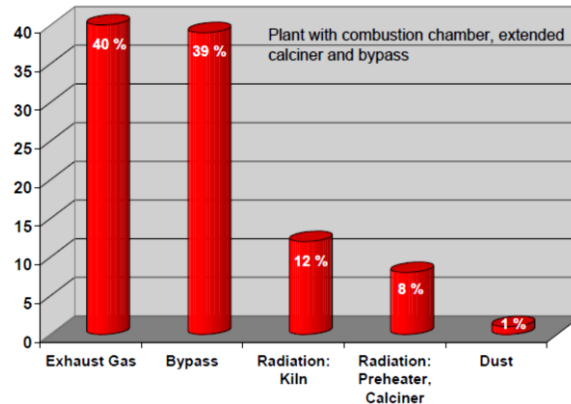

Figure 10. Breakdown of extra 10 percent heat consumption with co-processing, shown in Table 5 (Hand 2007)

2.6. Economics of Waste Co-processing

The overall cost of waste co-processing includes the capital and operating costs of the following (U.S. EPA 2008):

- Kiln and equipment upgrades
- Performance testing
- Waste pre-processing Materials acquisition and transportation: This cost can be negative, if the cement plant charges a waste co-processing fee for the service.
- Continuous emissions monitoring systems (CEMS)
- Sampling and testing of materials
- Operation, health and safety (OH&S): specific personal protective equipment and training

Sometimes, the above costs associated with pre- and co-processing of waste are greater than the energy and material value of the waste; therefore, a waste fee might need to be levied to be collected by cement plants co-processing the waste. In some cases has waste co-processing been profitable, such as in Japan where a high value is placed on waste treatment (GTZ/Holcim 2006).

Technical standards and country-specific environmental policies and incentives largely affect the economics of waste co-processing in the cement industry (GTZ/Holcim 2006). In addition, fuel prices vary

from country to country and even among regions within a country. Therefore, the economics of co-processing should be assessed according to the specific location and circumstances of each plant. The type of kiln at the cement plant (wet kiln, long dry kiln, preheater kiln, or new suspension preheater [NSP] kiln) influences the financial feasibility of waste co-processing as well. Wet kiln and long dry kiln technologies are not as energy efficient as are more modern NSP kilns; thus, plants with older-technology kilns have a greater need to reduce fuel costs in order to remain competitive with newer plants (U.S. EPA 2008).

Other factors that affect the financial viability of co-processing are: the increasing costs of fossil fuels; regional, national, or international emissions caps or carbon trading schemes; the avoided cost of installing new waste incinerators or managing new landfill sites; and incentives related to alternative energy sources (Genon and Brizio 2008).

GTZ/Holcim (2006) suggests that the “polluter pays” principle should be applied in the economic analysis of waste co-processing. According to this principle, those who produce waste (e.g., industry) or are responsible for its handling (e.g., municipalities) have to ensure and pay for the best, environmentally sound management of that waste.

Some regulations can make co-processing of MSW and/or sewage sludge more economically attractive. Examples of supportive regulations include: restrictions or limits on landfill availability for MSW and / or sewage sludge, higher fossil fuel prices, carbon taxes, and carbon trading schemes. A policy prohibiting landfilling of untreated sewage sludge in California, for example, drives the beneficial use of sewage sludge in that state. In California, the sludge has to be first dried at temperatures of at least 60°C to generate “Class A biosolids,” which is suitable for co-processing in cement kilns (U.S. EPA 2008). Also, in Switzerland, the agricultural use of sewage sludge is banned due to health concerns¹.

Figure 11 shows an example fuel cost profile for a cement plant and the target use of alternative (secondary) fuels. This figure shows reduced energy costs per tonne of clinker over time as a result of replacing expensive coal and other fossil fuels with lower-price alternative fuels and raw materials.

¹ Bruno Fux, Holcim. Personal communication. June 2012.

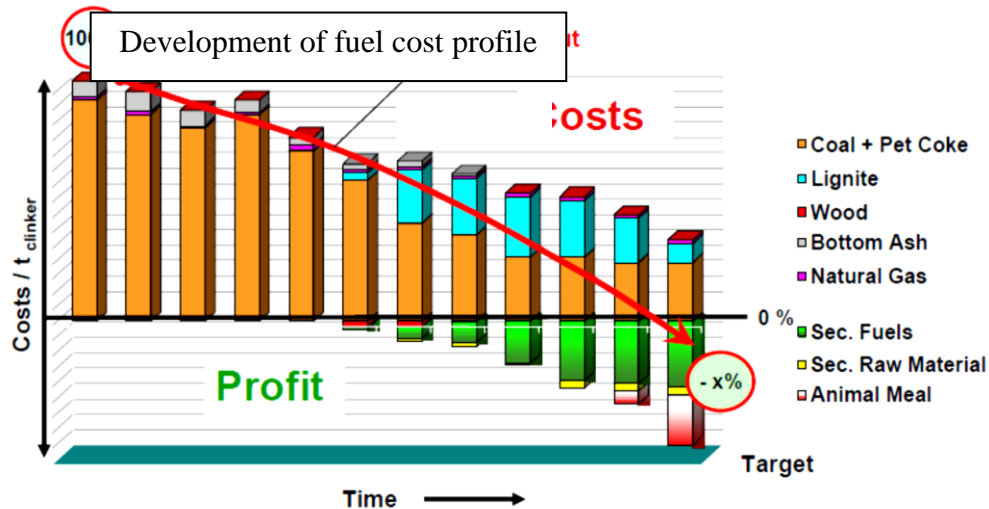

Figure 11. An example fuel cost profile for a cement plant with target use of alternative (secondary [Sec.]) fuels (Hand 2007)

The China Energy Group at the Lawrence Berkeley National Laboratory has developed a techno-economic analysis tool called Sewage Sludge Use in Cement Companies as an Energy Source (SUCCESS tool). This Excel-based tool assists decision makers in implementing sewage sludge co-processing schemes with optimal economic and environmental outcomes. The tool is in its beta version and is being tested on sewage sludge co-processing projects.²

2.7. Health and Environmental Risks of Co-processing

Lack of emissions controls for cement kilns, especially for kilns that are co-processing waste, can result in extremely high concentrations of particulates in ambient air. Exposure of local communities to these emissions has resulted in increased cases of respiratory, skin, and gastrointestinal disease as well as eye irritation (Karstensen 2007a). Exposure to hazardous air pollutants (HAPs) in sufficient concentration for a sufficient period of time can increase the chances of cancer or other serious health effects including immune system damage and neurological, reproductive, developmental, or respiratory problems (U.S. EPA 2012d). Cement kiln emissions also have detrimental environmental impacts. For example, nitrogen oxide (NOx) emissions from cement kilns can cause or contribute to adverse environmental impacts such as ground-level ozone, acid rain, and water quality deterioration (U.S. EPA 2012d). Since the 1970s, the increasingly strict controls on emissions from cement plants have considerably reduced the potential for public exposure to and environmental impacts of hazardous emissions.

With the recent increase in waste co-processing in cement kilns, concern has been raised regarding whether the chemicals emitted when cement plants treat waste might threaten public health. This concern is largely based on the supposition that such plants emit much greater amounts of potentially

² For further information about the SUCCESS tool, please contact Ali Hasanbeigi AHasanbeigi@lbl.gov or Lynn Price LKPrice@lbl.gov.

toxic chemicals than those using only conventional fuel (Karstensen 2007a). If MSW and sewage sludge are co-processed correctly and according to stringent environmental and emissions standards and regulations, there are no additional health and environmental risks compared to those that result when coal is used as a fuel (Rovira et al. 2011; Zabaniotou and Theofilou 2008; Karstensen 2008). See Sections 4.5.1 and 4.6 for further details.

2.8. Key Barriers to Co-processing

Some of the key barriers to co-processing of MSW and sewage sludge in the cement industry are listed below:

- **Permitting:** Although the cement industry prefers uniform emissions standards for co-processors rather than case-by-case permitting of waste co-processing at plants, for some hazardous waste co-processing, case-by-case permitting is necessary to ensure environmental and health safety and compliance.
- **Regulations and standards:** Some countries lack specific regulations and standards for co-processing of waste in the cement industry. Inadequate enforcement of waste management regulations in many developing countries is also one of the key barriers.
- **Supportive policies:** In many cases, co-processing might not be financially viable on its own if its larger societal (waste management) benefits are not taken into account. Municipalities and governments that wish to pursue co-processing should design programs and incentives based on co-processing's full benefits to the local community and environment.
- **Public acceptance:** Local residents and groups often perceive waste co-processing to be the same as waste incineration and automatically resist co-processing of MSW and sewage sludge in cement kilns. The major concern is usually the emissions from waste combustion, especially dioxin; this is a legitimate concern. Basic knowledge about waste co-processing and how it differs from waste incineration as well as its potential benefits is important to share at both national and local levels. Authorities should openly and publicly communicate emissions monitoring data and information from co-processing cement plants to assure the community that pollutant emissions comply with permitted levels.
- **Cost:** Costs of RDF production and sewage sludge pre-processing and co-processing are usually higher than existing landfill fees. However, it should be noted that most current landfill charges do not fully account for the costs of future ground water contamination or greenhouse gas (e.g. methane) emissions. Thus, either those externality costs should be included in landfill charges or financial incentives or supportive programs must be in place to make waste co-processing financially competitive with other waste treatment/disposal options.
- **Infrastructure:**
 - Existing infrastructure for sewage sludge is largely based on applying sludge to land or landfilling. Alternative infrastructure is needed for transport and pre-processing to cement plants.
 - MSW generators (local governments) might need to install equipment and establish procedures to adequately segregate materials in MSW and generate RDF.

- **Lack of qualified workforce:** The co-processing of waste in cement plants requires highly qualified experts to install and set up the equipment and trained personnel to operate the equipment. This capacity is presently limited in most developing countries.

3. Legal, Regulatory, and Institutional Frameworks for Co-processing: International Best Practices

Effective regulatory and institutional frameworks are critical to ensure that cement industry co-processing practices do not have negative health or environmental impacts. If co-processing is conducted in an environmentally sound manner, with proper sorting and pretreatment of waste, acceptance criteria clearly defined, quality control of waste inputs, clear regulations and enforcement to prevent pollution, and rigorous systems for site selection and permitting, co-processing can be an attractive alternative to deal with these waste, using them as alternative fuel and raw material for the cement industry. However, when adequate regulations are not in place, bad practices could lead to negative human and environmental health impacts (see Section 2.7).

Many developed countries have been operating co-processing plants since the 1970s. By 2008, Germany had replaced 54 percent of conventional fuel used in the cement industry with RDF (VDZ, 2010), and the Netherlands had replaced more than 80 percent. To safeguard the health and safety of residents near and employees in plants that are co-processing waste fuel, governments have established rules, regulations, and standards to regulate, monitor, and evaluate plant performance. In countries, such as Japan, Norway, and Switzerland, where land for waste landfill is very limited and resources are constrained, co-processing has played an important role in waste management, resource conservation, and energy efficiency (WBCSD, 2005).

This section of this report summarizes best practices for two common waste fuels/raw materials in the cement industry, MSW and sewage sludge. The subsections below cover legal, regulatory, and institutional frameworks that have been established in European countries, with examples from Germany, Finland, Italy, Switzerland, Austria, and France, as well as other countries, including Japan, the United States, Australia, Brazil, and South Africa.

3.1. General Legal Frameworks

Countries and regions have established legal frameworks and regulation requirements in addressing the issue of utilizing wastes in co-processing industries. This section reviews key policies and regulations that are developed and implemented internationally, in key regions, and in selected developed and developing countries, and then discusses and compares key environmental performance requirements at different levels of different systems.

Internationally, the Basel Convention plays an important role in creating internationally accepted rules and legal frameworks for addressing hazardous wastes and the use of hazardous wastes in co-processing in the cement industry. Adopted in 1989 and effective as of May 5, 1992, the Basel Convention was established to address concerns over management, disposal and transboundary movements of hazardous wastes. Currently, 178 countries have joined the Basel Convention.

At the 10th Meeting of the Conference of the Parties to the Basel Convention in October 2011, the Parties adopted technical guidelines for the environmentally-sound co-processing of hazardous waste in cement kilns. The guidelines stipulate that “any transboundary export, import or transit is permitted only when both the movement and the disposal of the hazardous wastes are environmentally sound” (Basel Convention, 2011). Countries that are parties to the Basel Convention are obligated to ensure the environmentally sound management of hazardous and other wastes. The technical guidelines serve as a main reference for the ongoing development of legal frameworks for the co-processing industry, for use in developing and developed countries.

Developed countries have established overarching legal frameworks in their countries for waste management that provide the basis for integrating co-processing into the waste management system. Examples of these legal frameworks in the European Union (EU), the United States, and Japan are described below.

3.1.1. European Union

Waste Framework Directive

The European Union sets its basic waste policy through the Waste Framework Directive (2008/98/EC) (WFD). All member states are required to align their national laws with the directive within a defined period of time. The WFD establishes basic concepts and definitions, including waste prevention, recovery, recycling, and management. The directive also establishes waste management principles, requiring that “waste be managed without endangering human health and harming the environment, and in particular without risk to water, air, soil, plants or animals, without causing a nuisance through noise or odors, and without adversely affecting the countryside or places of special interest” (EC, 2012a).

In addition, the WFD stipulates a waste management hierarchy (Figure 5 in Section 2.2.) that prioritizes waste prevention, followed by reuse or recycling of wastes, recovery in the form of energy, and, as a last option, disposal by landfilling. Co-processing of MSW and sewage sludge in the cement industry is regarded as energy recovery and is thus prioritized over landfilling.

Waste prevention and reuse and recycling of wastes should not be seen as competing or conflicting with co-processing. All serve the overall goal of reducing negative impacts of increasing quantities of waste. Moreover, co-processing is only feasible if municipal waste is sorted, and properly pretreated. The WFD establishes two waste recycling and recovery targets: a re-use and recycling rate of 50 percent for household waste materials (including paper, metal, plastic, and glass) by 2020, and a reuse - recycling target of 70 percent for construction and demolition waste by 2020 (EC, 2012a).

The EU WFD also outlines general principles for waste collection and management. Based on the “polluter pays” principle, the WFD specifically requires that producers or holders of waste must carry out waste treatment themselves or have treatment carried out by a broker or establishment. The WFD also opens the waste management market through “extended producer responsibility,” which shifts waste treatment responsibilities from the government to the waste-producing entities.

These principles provide strong incentives for co-processing because waste-producing facilities (such as industrial companies), and waste-handling organizations (such as municipalities) must pay the cement industry for waste treatment when waste is co-processed. The price of waste treatment varies among nations. In Japan, for example, where natural resources are heavily constrained, the price of waste treatment is usually high; therefore, co-processing plants realize high profit margins.

To ensure implementation, the WFD requires all EU member states to establish “one or more [waste] management plans” that should contain “the type, quantity and source of waste, existing collection systems and location criteria,” and information on waste prevention programs. The purpose of the waste management plans is to analyze current waste management practices; identify measures to improve reuse, recycling, recovery and disposal of waste; and determine how to support the implementation of the WFD. In addition to the general WFD, the European Commission has also issued several specific directives on landfills, waste incineration, pollution, and industrial emissions, which are relevant to waste co-processing and are discussed below.

Landfill Directive

One of the most influential drivers of cement kiln co-processing in Europe was the establishment of the Landfill Directive (1999/31/EC) (EC, 2012b) in 1999. The Landfill Directive was issued in response to growing concerns about the negative effects of landfilling of wastes, including contamination of soil, water resources, and air and resulting deterioration in living conditions and human health. The ultimate goal of the directive is to implement the EU’s waste hierarchy, which defines landfills as the last option for waste treatment and disposal.

The Landfill Directive introduces tight procedures for waste landfills, such as the development of landfill categories, setting up of a standard waste acceptance procedure for landfills (including detailed descriptions of waste characterization procedures, limits on waste composition, leaching behaviors, and acceptance procedures at landfill sites) (EC, 2009), and requires a landfill permitting system. The directive also imposes staged landfill reduction targets for the biodegradable fraction of MSW, liquid waste, and used tires. Member states are obliged to devise national strategies to meet the landfill reduction targets. Examples of a national strategy are Sweden’s 2002 ban on landfilling of separated combustible waste and 2005 ban on landfilling of organic waste.

Because the Landfill Directive limits the landfill capacity, it has pushed the market to find alternative waste treatment measures for wastes that cannot be reused or recycled. Incineration and co-processing are two of these measures. Landfills cost vary among EU countries, ranging from 30 Euro/tonne in Greece to 126 Euro /tonne in Denmark (Eunomia Research & Consulting, 2011). To comply with the Landfill Directive, countries have introduced various measures to increase the cost of landfilling. For example, the gate fee for landfilling in Finland increased 300 percent from 1996 to 2006. Landfill taxes are also used to discourage landfilling of waste in Estonia, Finland, and Italy (European Environmental Agency, 2009).

Waste Incineration Directive

To address public concern about the health and environmental impacts of burning waste, the European Commission formulated the Waste Incineration Directive (WID) (2000/76/EC) (EC, 2009) in 2000. The goal of the WID is to minimize the negative environmental impacts of waste incineration by establishing operational and technical requirements and emission limits for waste-burning plants.

The WID merged three previous directives³ related to waste incineration and co-processing and distinguished between incineration plants and co-processing plants. Under the WID, incineration plants in the European Union are defined as plants “which are dedicated to thermal treatment of waste and may or may not recover heat generated by combustion” (EC, 2012c) Co-incineration plants are those “whose main purpose is energy generation or the production of material products and in which waste is used as a fuel or is thermally treated for the purpose of disposal, such as cement or lime kilns” (EC, 2012c). Both types of plants are subject to the WID, and exceptions are granted to plants that are experimenting with processes to improve incineration; plants that treat fewer than 50 tonnes of wastes per year; and plants that are only treating vegetable wastes, certain wood wastes, and radioactive wastes (EC, 2011a).

The WID lays out requirements for co-processing plant permits, delivery and reception of waste, operational conditions, air emissions limits, water discharges, residues, monitoring and surveillance, access to information and public participation, reporting, and penalties. In particular, the directive imposes stricter regulations on emissions and more stringent operational conditions and technical requirements than were previously in force.

Integrated Pollution Prevention and Control Directive

In addition to the WID’s emissions limits and other specific requirements, the Integrated Pollution Prevention and Control (IPPC) Directive also applies to co-processing plants. The IPPC Directive aims to reduce industrial pollution using an integrated approach that centers around an environmental permitting system and the application of “best available techniques” (BATs).

The IPPC Directive calls for the technological status of key industries to be defined and described throughout Europe at regular intervals. BAT reference documents were developed for this purpose by experts in the different sectors based on an exchange of information organized by the European Commission. One BAT reference document relates to the cement and lime industry (EIPPCB, 2010), and two BAT reference documents relate to wastes (EIPPCB, 2006); one on waste treatment industries discusses different types of waste treatment technologies, and the other on waste incineration covers best available technologies for thermal treatment of wastes, as well as reception, handling, and storage of waste. The BAT reference documents expressly acknowledge that use of suitable waste in the cement manufacturing process is a BAT.

³ Including the Directive for New MSW Incineration Plants (89/369/EEC), the Directive for Existing MSW Incineration Plants (89/429/EEC), and the Directive for Hazardous Waste Incineration (94/67/EC).

To receive a permit, industrial facilities that are covered by the IPPC Directive must demonstrate that they use BATs and meet general obligations (such as preventing large-scale pollution, using energy efficiently, and limiting damage to the environment), specific requirements (emission limits; soil, water, and air protection measures; and waste management measures), and comprehensive plant performance requirements (EC, 2011b).

While requiring that industrial installations meet its requirements in order to minimize pollution, the IPPC Directive also gives flexibility to EU member states so that the environmental permitting authorities can take into account factors such as the technical characteristics of a facility, its geographic location, and local environmental conditions.

The IPPC Directive sees public participation as vital in the decision making process related to environmental permits and monitoring. It gives the public access to permit applications, permits, monitoring results, and the European Pollutant Release and Transfer Register (E-PRTR), a database containing emissions data reported by member states (E-PRTR, 2011).

Industrial Emissions Directive

The Industrial Emissions Directive (2010/75/EC) has been established to succeed the IPPC Directive when the IPPC Directive expires in 2013 (EC, 2011c). The Industrial Emissions Directive integrates seven existing directives⁴ related to industrial emissions and restates the principles outlined in the IPPC Directive, including an environmental permitting system based on an integrated approach, required adoption of BATs, flexibility of licensing authorities, and facilitating public participation in the permitting process as well as public access to reported data on emission/pollutants.

However, unlike the IPPC Directive, the Industrial Emissions Directive requires EU member states to establish a system of environmental inspections, prepare environmental inspection plans, and conduct site visits every 1 to 3 years depending on the pollution risk posed by a site (EC, 2012d).

3.1.2. United States

Clean Air Act

Different from the EU's cement industry co-processing regulations, which originated from concerns about waste generation, pollution, and landfill shortages, the U.S. regulations for co-processing were largely the result of concerns related to environmental protection and the implementation of the 1970 Clean Air Act.

The Clean Air Act was established to protect human health and the environment from harmful emissions to the air. The act requires the U.S. Environmental Protection Agency (EPA) to set minimum national standards for air quality and assigns to the states primary responsibility for ensuring compliance with

⁴ These include the IPPC Directive, the Large Combustion Plants Directive, the Waste Incineration Directive, the Solvents Emissions Directive, and three directives on titanium dioxide.

these standards. Areas that are not meeting the emission standards, called “nonattainment areas,” are required to implement specific air pollution control measures. The act establishes federal standards for both stationary and mobile sources of air pollution and lists hazardous air pollutant (HAPs) and emissions that cause acid rain. In addition, the act establishes a comprehensive permit system for all sources of air pollution⁵.

Section 109 of the Clean Air Act requires U.S. EPA to set national ambient air quality standards for six main pollutants, called “criteria pollutants”: carbon monoxide (CO), lead (Pb), nitrogen dioxide, ozone, particulate matter 2.5 and 10 microns in size (PM 2.5 and PM10), and SO₂. Two types of standards are developed: primary standards to protect public health and secondary standards to protect public welfare (e.g., protection against damage to animals, crops, and buildings) (EPA, 2011a). The Clean Air Act requires U.S. EPA to review the standards every 5 years. States are responsible for establishing procedures and measures to meet the standards. Under Section 110 of the Clean Air Act, the states adopt state implementation plans and submit them to U.S. EPA.

Section 112 of the Clean Air Act also requires U.S. EPA to set standards for major sources and certain area sources emitting HAPs that are known or suspected to cause cancer or other serious health effects. A “major source” is defined as a stationary source or group of stationary sources that emit or have the potential to emit 10 tons per year or more of a HAP or 25 tons per year or more of a combination of HAPs (EPA, 2012a).

Section 112 of the Clean Air Act defines and regulates 188 HAPs. The national emission standards for HAPs require adoption of technology-based emission standards; the technologies required by these standards are referred to as maximum achievable control technologies (MACTs). U.S. EPA is required to review these standards periodically.

Because co-processing in the cement industry recovers energy from combustion of solid wastes, cement kilns that co-process MSW and sewage sludge must meet the emissions limits for the nine pollutants specified in Section 129 of the Clean Air Act:

- cadmium (Cd)
- CO
- total mass basis polychlorinated dibenzo-p-dioxin / polychlorinated dibenzofuran (PCDD/PCDF) and toxic equivalency basis (TEQ) PCDD/PCDFs
- HCl
- Pb
- mercury (Hg)
- NO_x

⁵ Also, on December 7, 2009, EPA signed two distinct findings (Endangerment Finding and Cause or Contribute Finding) regarding greenhouse gases under section 202(a) of the Clean Air Act. Endangerment Finding indicates that six GHGs threaten the public health and welfare of current and future generation. However, these findings do not themselves impose any requirements on industry or other entities.

- PM
- SO₂

3.1.3. Japan

Japan is aggressively pursuing three types of MSW and sewage sludge treatment: use of sewage sludge and MSW incinerator ash as an alternative raw material in the production of Portland cement and concrete aggregate; use of incinerator ash as an alternative raw material in specially designated cement products (Eco-cement); and use of MSW as an alternative fuel in cement kilns. These strategies were developed in response to scarce landfill area, relatively high landfill disposal fees, and a policy framework that supports research on waste reuse and gives generous economic incentives to industrial ecology projects (Hotta and Aoki-Suzuki 2010; Nakamura 2007).

Japan's Waste Management and Public Cleaning Law was established in 1970. During the past decade, Japan has developed an integrated waste and material management approach that promotes dematerialization and resource efficiency. Landfill shortage and dependency on imported natural resources have been key drivers of these changes. The 2000 Basic Law for Establishing a Sound Material-Cycle Society integrated the environmentally sound management of waste with the "3R" (reduce, reuse, and recycle) approach. This represents a shift in emphasis from waste management to sound materials management.

3.2. Regulations and Standards

Regulations and standards are established to describe day-to-day implementation of laws and directives. For co-processing in the cement industry, rigorous regulations and standards are needed in five key areas: environmental performance, product quality, waste quality, operational practices, and safety and health requirements for employees and local residents. The subsections below describe the establishment and implementation of regulations and standards in Europe, the United States, and Japan to address these five areas.

Key factors affecting the environmental performance of co-processing plants include the behavior of individual heavy metals in the rotary kiln, waste input conditions, and the efficiency of the plant's dust collector (Bolwerk et al. 2006). Co-processing plants need to carefully control the quality of waste inputs, continuously monitor emissions parameters, adopt adequate operational controls, and establish a system of regular reporting to local government. The reported information must be transparent, and information on emissions and the quality of waste input must be publicly available to local communities (GTZ/Holcim 2006).

3.2.1. Environmental performance requirements

The high temperatures in rotary kilns ensure that organic substances in wastes are almost entirely converted to CO₂ and water and that the emissions concentrations of organic compounds, such as dioxins and furans, are very low. Nonetheless, air emissions, water discharges, and residues from co-

processing plants must be carefully regulated, monitored, and reported. Many countries around the world have established emissions limits for different types of pollutants from co-processing plants, some of which are described below.

European Union

The EU WID establishes limits on the emissions of heavy metals, dioxins and furans, CO, dust, total organic carbon, HCl, HF, SO₂, and NO_x from co-processing plants. Table 6 shows the EU emissions limits (daily average values for continuous measurements) for cement co-processing plants that treat nonhazardous wastes or less than 40 percent hazardous wastes. Dioxins and furans must be measured at least twice per year, and at least every 3 months for the first 12 months of a plant's operation. Dust from de-dusting equipment can be partially or totally recycled into cement manufacturing processes. If recycling is not feasible or not allowed, the dust must be evaluated before use in soil or waste stabilization or for agricultural purpose (GTZ/Holcim 2006). If dust is landfilled, the landfill design must use BAT.

The WID allows CO emissions from cement co-processing plants to be set by a “competent authority” within EU member states, i.e., government/regulators in EU member states. EU member states have incorporated the emissions limits into their national standards. For example, Germany's emission limits are set in the German Clean Air Standards (TA Luft 2002).

Table 6. Air Emissions Limits for cement co-processing plants from EU Waste Incineration Directive (EC, 2012c)

Daily Average Value ¹ (in milligrams per cubic meter [mg/m ³])	Limit for Cement Co-Processing Plants
Total Dust	30
HCl	10
HF	1
NO _x for existing plants	800
NO _x for new plants	500
Cd + Tl	0.05
Hg	0.05
Sb + As + Pb + Cr + Co + Cu + Mn + Ni + V	0.5
Dioxins and furans	0.1
SO ₂	50
TOC ²	10
CO ²	Set by member states

HCl: hydrogen chloride; HF: Hydrogen Fluoride; NO_x: nitrogen oxides; Cd: cadmium; Tl: Thallium; Hg: mercury; Sb: Antimony; As: Arsenic; Pb: lead; Cr: Chromium; Co: Cobalt; Cu: Copper; Mn: Manganese; Ni: Nickel; V: Vanadium; SO₂: sulfur dioxide; TOC: total organic compounds; CO: carbon monoxide;

Notes: 1 daily average values for continuous measurements; 2 Exceptions may be authorized by competent authority if TOC and SO₂ do not result from the incineration of waste.

The WID also regulates 11 polluting substances in discharge water from exhaust-gas cleanup at co-processing plants. The pollutants include total suspended solids, Hg, Thallium (Tl), and Pb. Emission limits for discharges of waste water are presented in Table 7.

Table 7. Emission Limits of 11 Pollutes in Discharge Waste Water from Co-Processing Plants (EC, 2012c)

Polluting substances	Emission limit values expressed in mass concentrations for unfiltered samples	
Total suspended solids as defined by Directive 91/271/EC	95% 30 mg/l	100% 45 mg/l
Mercury and its compounds (Hg)	0.03 mg/l	
Cadmium and its compounds (Cd)	0.05 mg/l	
Thallium and its compounds (Tl)	0.05 mg/l	
Arsenic and its compounds (As)	0.15 mg/l	
Lead and its compounds (Pb)	0.2 mg/l	
Chromium and its compounds (Cr)	0.5 mg/l	
Copper and its compounds (Cu)	0.5 mg/l	
Nickel and its compounds (Ni)	0.5 mg/l	
Zinc and its compounds (Zn)	1.5 mg/l	
Dioxins and furans	0.3 mg/l	

In most EU countries, test burns are usually conducted to evaluate the performance of a new technology or process to reduce emissions; the quality of the resulting clinker is also evaluated to ensure that hazardous residues from the waste-treating process do not leach from the final product and pose an environmental hazard. (GTZ/Holcim 2006).

United States

As required by the U.S. Clean Air Act, the U.S. EPA has developed a list of “source categories,” including co-processing cement plants that must meet and control technology requirements for toxic air pollutants. Maximum Achievable Control Technology (MACT) standards are established under Section 112 of the Act through the national emissions standards for HAPs. The MACT Standards, such as the Portland Cement Kiln MACT, are intended to achieve “the maximum degree of reduction in emissions,” while taking into account cost, non-air-quality health and environmental impacts, and energy requirements (McCarthy, 2005). For new facilities or “new sources” of air emissions, the act specifies that MACT standards “shall not be less stringent than the most stringent emissions level that is achieved in practice by the best controlled similar source.” For existing facilities or “existing sources” of air emissions, the standards may be less stringent than for new sources but “must be no less stringent than the emission limitations achieved by either the best performing 12 percent of the existing sources or the best performing 5 similar sources.” Typically, existing sources have 3 years after promulgation of standards to achieve compliance, with a possible 1-year extension (McCarthy, 2005). Existing sources that achieve voluntary early emissions reductions receive a 6-year extension for compliance with MACT (McCarthy, 2005).

The emission level or so-called “MACT floor” is a baseline that facilities are required to achieve throughout the industry in the United States. MACT standards in effect set mandatory emission limits across industries, and U.S. EPA can establish more stringent standards when needed. U.S. EPA states that this “technology-based” approach produces “real, measurable reductions” (EPA, 2011b). Based on the MACT standards, U.S. EPA conducts risk-based emissions assessments to determine how the technology-based emissions limits actually reduce health and environmental risks.

Emissions standards for the U.S. cement industry are specified in the Code of Federal Regulations 40 (Protection of Environment), Part 60 (Standards of Performance for New Stationary Sources), Subpart F (Standards of Performance for Portland Cement Plants). The standards apply to kilns, clinker coolers, raw mill systems, finish mill systems, raw mill dryers, raw material storage, clinker storage, finished product storage, conveyor transfer points, bagging, and bulk loading and unloading systems (Clean Air Act, 2012). Table 8 shows U.S. emissions limits for PM, NO_x, and SO₂.

Table 8. Emissions Limits for U.S. Cement Plants (Clean Air Act, 2012)

Pollutant	Kilns	Clinker Coolers
Particulate Matter (PM)	0.15 kg/tonne of feed (dry basis) to the kiln	0.05 kg/tonne of feed (dry basis) to the kiln
	0.005 kg/tonne of clinker (on a 30-operating day rolling average)	0.005 kg/tonne of clinker (on a 30-operating day rolling average)
Nitrogen Oxide (NO _x)	0.75 kg/tonne of clinker	-
Sulphur Dioxide (SO ₂)	0.2 kg/tonne of clinker	-

The Clean Air Act Amendments of 1990 added Section 129 to address emissions from solid waste combustion units. This amendment established emissions standards for new facilities (new source performance standards) as well as standards for existing units (emission guidelines). The latter do not regulate existing emissions sources directly but require states to implement guidelines. Both the new source performance standards and the emission guidelines use a MACT approach like that used in Section 112 of the Clean Air Act (EPA, 2012b).

Prior to 2007, co-processing cement plants treating nonhazardous secondary materials in the United States were regulated under the Clean Air Act Section 112 Portland Cement Kiln MACT standard. However, in 2007, a U.S. Court of Appeals concluded that U.S. EPA “erred by excluding units that combust solid waste for purposes of energy recovery from the [Commercial and Industrial Solid Waste Incineration] rule” (EPA, 2008). In response to the court’s decision, U.S. EPA proposed the “Non-hazardous Solid Waste Definition Rulemaking” to establish which nonhazardous secondary materials are considered solid waste when burned in a combustion unit. According to the definition of nonhazardous solid waste that resulted from this rulemaking, co-processing cement plants that burn nonhazardous solid wastes are regulated by the standards of performance for new stationary sources as well as the emissions guidelines for existing sources (commercial and industrial solid waste incineration [CISWI] units), under the authority of Section 129 of the Clean Air Act, rather than the Portland Cement Kiln MACT standard under Section 112.

A two-stage approach was developed to regulate CISWI emissions, including those from cement plants that burn nonhazardous solid waste. In the first stage, EPA established technology-based (MACT) emission standards. U.S. EPA is required to review these standards as necessary every five years. In the second stage, EPA is required to determine whether further revisions of the standard are necessary to “provide an ample margin of safety to protect public health” (U.S. EPA, 2011c). CISWI MACT standards for cement kilns are based on an inventory of 12 kilns, including one wet kiln, four preheater kilns, and seven preheater/precalciner kilns. Kilns that burn tires, used oil, biomass, and wood waste are not considered to fall within the scope of the CISWI standards because these fuels are not within the definition of “nonhazardous solid wastes” that resulted from the 2007 rulemaking.

The final CISWI standards were released and took effect on March 21, 2011. However, U.S. EPA received petitions from a number of groups seeking reconsideration of the rule. The agency identified several issues for reconsideration and on May 18, 2011 announced a delay in the effective date of the standards until “the proceedings for judicial review of these rules are completed or the U.S. EPA completes its reconsideration of the rule” (EPA, 2011d) On December 23, 2011, EPA announced proposed amendments to the CISWI standards, including reconsideration of subcategories (e.g., types of cement kilns), revisions to CO monitoring requirements, clarification of definitions, and proposed amendments to emission limits for co-processing cement plants. Table 9 shows the delayed 2011 CISWI standards and proposed amendments applicable to cement plant emissions.

Co-processing cement plants that treat hazardous waste are subject to the hazardous waste combustors regulation under Section 112 of the Clean Air Act. This regulation, “National Emission Standards for Hazardous Air Pollutants: Final Standards for Hazardous Air Pollutants for Hazardous Waste Combustors,” was established in October 2005 and requires hazardous-waste-treating cement kilns to meet the emissions standards for HAPs, including As, beryllium, Cd, chromium, dioxins and furans, HCl, chlorine gas, Pb, manganese, and Hg (U.S. EPA, 2005).

**Table 9. MACT Emission Limits in 2011 CISWI Standards for U.S. Co-Processing Kilns
(U.S. EPA 2011c and 2011e)**

Pollutant (units) *	2011 CISWI Emission Limits (Implementation Delayed)		2011 CISWI Emission Limits (Proposed Amendments)	
	Existing Cement Kilns	New Cement Kilns	Existing Cement Kilns	New Cement Kilns
HCl (ppmv)	25	3.0	3.0	3.0
CO (ppmv)	110	90	410 (preheater/precalci ner)	320 (preheater/precalci ner)
Pb (mg/dscm)	0.0026	0.0026	0.0043	0.0043
Cd (mg/dscm)	0.00048	0.00048	0.00082	0.00082
Hg (mg/dscm)	0.0079	0.0062	0.011	0.0037
PM, filterable (mg/dscm)	6.2	2.5	9.2	8.9
Dioxin, furans, total (ng/dscm)	0.2	0.090	3.6	0.51
Dioxin, furans, TEQ (ng/dscm)	0.0070	0.0030	0.075	0.075
NO _x (ppmv)	540	200	630	200
SO ₂ (ppmv)	38	38	830	130

*ppmv: parts per million by volume; mg/dscm: milligrams per dry standard cubic meter; ng/dscm: nanograms per dry standard cubic meter.

Australia

In Australia, the state of Victoria governs the primary permitting and licensing of Australia’s only sewage co-processing cement plant (at Waurn Ponds). State governments in Australia have near full control over the design and implementation of environmental regulations (Anton, 2008). Federal regulations pertinent to the operation of cement plants govern the annual reporting of emissions to the National Pollutant Inventory and compliance with the national carbon tax which comes into force July 1, 2012. Otherwise, environmental regulations such as pollutant emission limits and environmental impact assessment requirements are strictly the purview of state governments. Most waste, landfill, and work safety regulations are also the purview of the state governments. Cement and concrete product quality standards are set by a national non-governmental standards board, Standards Australia.

Boral Cement’s Waurn Ponds facility in Victoria has been using alternative fuels since the early 1990s, including tires, waste oil, tallow residues, carbon waste from the aluminum industry, catalyst waste from oil refining, and waste foundry sands (Boral Cement, 2011). In 2006, the plant began studying the feasibility of reusing biosolids from a nearby wastewater treatment facility as cement kiln fuel (APP, 2010). Waste characterization studies indicated that high mercury content in the biosolids was the primary obstacle to implementing the project. Various technological solutions were explored by plant managers to ensure that use of the sewage sludge would not increase plant mercury emissions over existing levels (a limitation self-imposed by plant managers to maintain good relations with the community) (McGrath, 2012). In a trial, fuel processing and feeding were standardized, and a technology produced by Hansom Environmental Products proved successful in eliminating 98 percent of mercury

emissions and significantly decreasing other pollutant emissions. Because of these pilot successes, Boral is enthusiastic about scaling up the project; however, doing so would require significant capital.

The biosolids delivered to the plant are not considered a waste, so the plant is not regulated as a waste treatment facility. Only the stack emissions are regulated under the state's environmental protection laws and permitting requirements. The plant has traditionally had a strong relationship with the local community and the state environmental regulator, the Environmental Protection Authority of Victoria (EPAV). Part of the impetus for the biosolids project was EPAV's pressure on the wastewater plant to explore cement co-processing for disposal (McGrath, 2012). Until recently, the plant's operating permits stipulated controls on the fuel inputs, with emission limits set by state law. Recently, these regulations have changed with the onus newly placed on the plant owner to use a risk-based approach to environmental management. When preparing a risk assessment, the plant must fully consider input from the community before regulators will grant a permit; community opposition can significantly delay or result in denial of a permit. Permits stipulate that the plant must provide regular reports on actual emissions and negative environmental impacts (McGrath, 2012). As a guideline, the plant's updated license (Nov. 2011) requires emissions limits in line with the EU's WID 2000/76/EC (EPA Victoria, 2011). Furthermore, the Cement Industry Federation of Australia requires that all of its member companies using alternative fuels and raw materials follow the World Business Council for Sustainable Development (WBCSD) "Guidelines for the Selection and Use of Fuels and Raw Materials in the Cement Manufacturing Process" (Cement Industry Federation, 2009). Several stakeholder meetings have been held to ensure that the local community is aware of and agrees to the biosolids project. These meetings have greatly increased incentives for the plant to keep emissions levels low. Annual reporting procedures are set by state guidelines.

South Africa

In 2009, the South Africa Department of Environment and Tourism promulgated a National Policy on the Thermal Treatment of General and Hazardous Waste (the South Africa National Policy) (Crous, 2009a). This extremely detailed policy replaces previously inconsistent requirements regarding regulation of waste co-processing at the provincial level (Karstensen, 2007b). The policy relies on the EU Incineration Directive 2000/76/EC (especially for air emissions limits) and other international policies, including co-processing guidelines by WBCSD and Holcim, as models. In addition to detailing permitting and operations requirements as set by existing laws, the policy also establishes BATs and best environmental practices for cement production, including emissions controls for co-processing. Provinces in South Africa have authority to promulgate more stringent environmental regulations than the central government and therefore can add regulatory obligations in addition to those specified in the national policy (Karstensen, 2008).

The South Africa National Policy also stipulates minimum air emissions limits for criteria air pollutants, heavy metals, dioxins, and furans for existing and new co-processors, as shown in Table 10. Existing plants currently permitted for co-processing have 10 years to bring emissions in line with the requirements that apply to new plants. Air quality management plans are required that detail the following: facility design and operations; monitoring equipment and minimum availability; requirements

for the frequency of monitoring certain gases; reporting units, style and frequency (one self-assessment quarterly, and an independent audit annually); and special monitoring for heavy metals, dioxins, and furans. A separate testing and verification process is required for high-level persistent-organic-pollutant (POP)-containing waste, which, if used, must be destroyed with a minimum efficiency of 99.99%.

The South Africa National Policy provisions are among the most stringent in the world although the language could be improved to clarify whether measures are suggested or mandatory. Because South Africa is home to only 11 cement plants, it is likely that any co-processing permitting will take place in close cooperation with provincial and national regulators. Policymakers focused on co-processing of hazardous wastes rather than MSW in the formation of the South Africa policy. Separate initiatives are addressing the MSW stream in more detail, and it is unclear whether those processes will ultimately advocate MSW co-processing (Crous, 2009b).

Table 10. Air Emission Standards for the Incineration of General and Hazardous Waste in Dedicated Incinerators and for the Co-processing of General and Hazardous Wastes as AFR in Cement Production, South Africa (South Africa Department of Environmental Affairs, 2009)

Pollutant (unit) [*]	Air Emission Standards for the Incineration of General and Hazardous Waste in Dedicated Incinerators	Air Emission Standards for the Co-processing of Selected General and Hazardous Waste as AFR in Cement Production
PM (Total Particulate Matter)	10	30 ⁱ (80) ⁱⁱ
TOC	10	10 ⁱⁱⁱ
CO	50	
HCl	10	10
HF	1	1
SO ₂	50	50 ⁱⁱⁱ
NO _x	200	800 ^{iv}
NH ₃	10	
Hg	0.05	0.05
Cd + Tl	0.05	0.05
SB, AS, Pb, Cr, Co, Cu, Mn, Ni, V (Sum total)	0.5	0.5
PCDD/PCDF (ng/Nm ³ I-TEQ)	0.1	0.1

*Concentration expressed as mg/Nm³ (Daily Average) unless otherwise stated, and at 'normalized' conditions of 10% O₂, 101.3 kPa, 273 K/0 °C, dry gas. Mg/Nm³: milligram per Normal cubic meter; I-TEQ: international Toxics Equivalent(s).

ⁱ PM limit for (a) new kilns (commissioned after promulgation of this policy) co-processing AFR, and for (b) existing kilns co-processing AFR within 10 years of promulgation of this policy.

ⁱⁱ PM limit effective after 3 years of promulgation of this policy for existing kilns co-processing AFR (excluding POPs waste), provided that current particulate emissions (as established through baseline monitoring) are not increased by the co-processing of AFR.

ⁱⁱⁱ Limits for TOC or SO₂ do not apply where elevated emissions result from conventional fuels or raw material, i.e. not from the co-processing of AFR, provided that current TOC and SO₂ emissions (as established through baseline monitoring) are not increased by the co-processing of AFR.

^{iv} NO_x limit for (a) new kilns (commissioned after promulgation of this policy) coprocessing AFR, and for (b) existing kilns co-processing AFR (excluding POPs waste) within 10 years of promulgation of this policy, provided that current NO_x emissions (as established through baseline monitoring) are not increased by the co-processing of AFR.

3.2.2. Product quality requirements

Section 2.4 describes the potential effects of using MSW and sewage sludge in the cement manufacturing on the trace element concentrations in the final product. Depending on the total input and type of wastes, the concentration of trace elements might increase or decrease relative to the composition of the cement produced with traditional fuels.

Product quality requirements are intended to ensure that the use of waste-derived fuels in the cement industry does not result in a negative impact on health or the environment or degrade the cement or clinker's material composition or the technical properties that are essential to its function as a building material.

As noted in Section 2.4, studies have identified three general principles that should be followed in developing regulations governing the quality of cement products (GTZ/Holcim 2006):

- The product (clinker, cement, concrete) must not be abused as a sink for heavy metals.
- The product should not have any negative impact on the environment.
- The quality of cement shall allow end-of-life recovery.

If co-processing is conducted in an environmentally sound manner, the use of MSW and sewage sludge reportedly has only a marginal impact on the heavy metal content of the clinker produced (GTZ/Holcim 2006). Studies from Germany have shown that heavy metals are firmly trapped in the cement brick matrix (Bolwerk et al. 2006). However, when products are stored under specific or extreme conditions, some releases have been detected at levels that could have environmental impacts (Bolwerk et al. 2006). To avoid negative product quality impacts, the quality and type of waste input to kilns should be carefully controlled, and the heavy metal content in the waste inputs should be limited. Co-processing plants should set up quality control systems to ensure environmentally safe operation. Wastes usually require pre-processing (e.g., drying, shredding, blending, grinding, or homogenization) and quality assurance (CEMBUREAU, 2009). All of these issues can be addressed in regulations.

European Union

EU regulations require cement products from co-processing process to meet all applicable quality standards, including the harmonized standard EN 197-1: Cement composition, specifications and conformity criteria. (CEMBUREAU, 2009)

In Germany, cement products (clinker, cement, and concrete) must meet state building regulations, the Construction Products Directive, and the Construction Products Law (which is based on the EU Construction Products Directive). VDZ, the German Cement Works Association, is responsible for testing, inspection, and certification of cement products. VDZ operates a quality surveillance organization and testing laboratory and serves as the inspection and certification body (VDZ, 2010). The Research Institute of the Cement Industry's Quality Assurance Department carries out inspection and test activities, and the technical committee of VDZ's quality surveillance organization discusses the results of third-party inspection twice a year (VDZ, 2010). VDZ's quality surveillance organization has been accredited as a product certification body according to EN 45011 since 2002, and all laboratory tests are accredited in accordance with International Standards Organization (ISO) 17025. The quality surveillance organization is regularly assessed by third parties.

3.2.3. Waste quality requirements

Compared with industrial wastes, which are normally generated from mono-streams, MSW is more difficult to handle because it is not homogeneous. Studies have shown that unsorted household wastes are not suitable for co-processing in the cement plants (IMPEL Network, 1998).

Co-processing plants must develop criteria to select wastes whose characteristics, when pre-processed, allow the plant to maintain operational and product quality requirements (IPT, 1999). Different types of wastes will have different effects on the quality of clinker or cement produced. See Appendix 3 for an example of an "accept-refuse" chart for a cement plant.

With the purpose of maintaining reliable quality while minimizing pollutant input from wastes, co-processing plant operators should develop an evaluation and acceptance procedure to collect basic information about waste origin and detailed data and information about the waste's physical and chemical properties, such as calorific value and chlorine, ash, and trace element (e.g., mercury) content. Information related to health, safety, and environmental considerations during transport, handling, and use must also be obtained. Plant operators should regularly sample and analyze input to and output of cement kilns.

Plant operators should, in particular, check for the following contents within wastes because these constituents significantly affect the quality of production (WBCSD, 2005 and GTZ/Holcim 2006):

- Phosphates, which influence setting time
- Chlorine, sulfur, and alkali, which affect overall product quality
 - Chlorine at concentrations greater than 0.7 percent can affect the strength of the clinker.
 - Chlorine can cause accelerated corrosion of the facility.
 - Chlorine affects the overall quality of cement and concrete.
- Chromium, which may cause allergic reactions in sensitive users.

Before allowing use of wastes in cement plants, regulators and plant operators should clearly understand the answers to the following questions (Bolwerk, no date):

- What types of wastes are suitable for use in the cement manufacturing process?
- What process does the waste come from?
- What pollutants does the waste contain?
- What are the following characteristics of the waste: calorific value, water content, heavy metal content, chlorine content, etc. (see list of key constituents above)?
- Can the waste provider ensure consistent quality within a defined spectrum?
- What are the expected emissions from treating the waste?
- What harmful substances might end up in the clinker or cement if the waste is used as fuel?

European Union

Germany has developed systems to assess and control the suitability of alternative fuel generated from wastes. These systems mainly focus on the trace element and the chlorine content of the waste. The acceptable chlorine concentration typically ranges from <1 percent to 2 percent and depends on the individual situation at the plant. Germany has introduced a certification label for waste-derived fuels used in the cement industry, and the Netherlands, Italy, and Finland have developed quality standards for waste-derived fuels as well.

The Swiss Agency for the Environment, Forests and Landscape published *Guidelines on Disposal of Waste in Cement Plants* in 1998; the guidelines were updated in 2005 and identify values for the pollutant content of clinker and Portland cement. If co-processing plants exceed the guidance values, they must reduce the amount of waste used.

3.2.4. Operational requirements

The EU WID requires that co-processing plants keep the co-processing gases “at a temperature of at least 850 °C for at least two seconds.” The waste heat from the co-processing process must also be utilized “as far as possible.” The burning process should be monitored continuously by process control technology.

Wastes containing volatile organic compounds (VOCs) must be stored and handled to allow suppression or containment of these components, such as in closed tanks or containers and appropriate air ventilation. Common techniques for capturing VOC emissions include nitrogen traps, biological treatment, activated carbon filters, and thermal treatment (GTZ/Holcim 2006).

European Union

In Germany, all processes must be designed for low emissions and monitored by recording process variables. The following requirements are suggested in Germany based on German case studies (IMPEL Network, 1998):

- The burning process must be monitored continuously using modern process control technology.
- Fixed inspections and comprehensive preliminary homogenization are needed for waste materials upon arrival.

- The main parameters for analyzing the waste material (e.g., calorific values, chemical composition) must be input to the process control system on a semi-continuous basis.
- The feed lance must be designed to inject the waste centrally.
- The control units must follow the waste fuel independently of the main fuel.
- Waste fuel may only be supplied during normal continuous operation within the rated output range.

South Africa

In South Africa, plants must also develop independently certified operational and environmental management plans (Karstensen, 2008). These plans specify responsible persons for each specific activity involved in waste receipt, handling, and treatment; training and recordkeeping; waste and alternative fuel and raw materials selection and analysis; process controls; monitoring equipment and accreditation and maintenance schedules; emissions monitoring strategies and schedules; operations procedures regarding waste feeding, startups and shutdowns, employee health checks, and environmental sampling; and procedures for updating the operational and environmental management plan. Hazardous waste treatment requires stringent and specific protocols. A waste management plan is also required in accordance with relevant national policies on handling, classification, and disposal of wastes, including specific regulations and standards regarding waste storage; transport contractors permitting requirements; and record-keeping requirements regarding waste origin, volume, physical characteristics, classification, risks (as designated by hazardous chemicals laws), caloric value, and methods for transport, storage, pre-processing, and feeding.

3.2.5. Safety and health requirements

Operations and management staff should receive sufficient resources and training to ensure that a co-processing system runs safely and efficiently. Preventative measures, such as operational and control monitoring, personal protective equipment, and storage facilities must be employed to minimize potential risk to employees and local residents.

Operations, maintenance, and safety procedures should be developed for both employees and plants and should be reviewed, updated, or modified regularly to ensure that they are fully implemented and meet the needs of changing operation conditions. Robust emergency procedures should also be developed.

As an example, to estimate the potential emissions hazards to human health and the ecosystem, Intertox Cement Company in Portugal conducted a risk assessment, which was based on a “worst-case scenario” of “cumulative less favorable occurrences” (CEMBUREAU, 2009). The assessment modeled emission levels to understand potential risks to employees’ health and the environment. Holcim Cement developed the ECHO (i.e., employees chemical health and occupational safety) program in the U.S., to monitor the health of its employees that are dealing with wastes.

3.3. Institutional Frameworks

Responsibility for regulation and enforcement is delegated in various ways in different countries. In the United States, the U.S. EPA regulates emissions from U.S. cement industry co-processing or delegates this authority to state or local agencies. However, U.S. EPA retains the approval authority for emissions standards, changes in emissions test methods, changes in emissions monitoring, and changes in recordkeeping and reporting (CAA, 2012).

The overarching regulation of air emissions in the United States is the Clean Air Act, which is the comprehensive federal law established in 1970 to regulate air emissions from both stationary and mobile sources. State and local air quality agencies are designated as the primary permitting and enforcement authorities for most Clean Air Act requirements. U.S. EPA is responsible for supervision of state and local actions to “ensure national consistency and adherence to Clean Air Act legal principles” (U.S. EPA, 2011f).

In most EU member states, regulatory and enforcement responsibility is divided among a number of different “competent authorities.” In several member states, such as Austria, Germany, Belgium, and Bulgaria, regulatory functions are divided between the national/federal level and the regional/state level. In other countries, such as in Denmark and Hungary, regional authorities carry out the major control functions for industrial installations. Regulatory functions are carried out at the municipal/local authority level in the Czech Republic, Netherlands, UK, and Ireland (Milieu, 2011).

3.3.1. Waste collection and management

Integrated waste management is a key concept that is widely recognized around the world; it signifies that all of the stages of waste, from generation to final disposal, should be considered when decisions are being made for any of the stages. Integrated waste management also entails considering all stakeholder perspectives: social, economic, environmental, technical, political, and institutional.

Integrated solid waste management is intended to protect clean, safe neighborhoods; increase the efficiency of resource usage; save waste management costs by reducing the amount of final waste requiring disposal; and create business opportunities and economic growth (Memon, no date).

Co-processing should be an integrated part of local and national waste management concepts and strategies (GTZ/Holcim 2006). The goal of co-processing MSW and sewage sludge in the cement industry is to increase resource efficiency, reduce fossil fuel consumption, and decrease greenhouse gas emissions. However, the use of wastes in the cement industry should not be a strategy for by-passing legislation regarding waste handling or disposal. As noted earlier, not all types of waste are suitable for co-processing.

Japan

In Japan, an integrated solid waste management plan includes the following (details are illustrated in Figure 12) (Memon, no date):

- Policies (regulatory, fiscal, etc.)
- Technologies (basic equipment and operational aspects)
- Voluntary measures (awareness/education, self-regulation)
- A management system covering all aspects of waste management (waste generation, collection, transfer, transportation, sorting, treatment and disposal)
- Data and information on waste characterization and quantification (including future trends)
- Assessment of current waste management system to see if it meets the needs of operational stages

Japan's local governments are generally responsible for enforcing national air quality standards and municipal waste treatment permitting regimes and have the power to enact more stringent regulations than the national standards. Efforts to co-process municipal solid waste and incinerator ash originated in the early 1990s in Japan with the passage of the Law for the Promotion of Utilization of Recyclable Resources (the Recycling Law) and the 1991 amendments to the Waste Disposal and Public Cleansing Law (the Waste Disposal Law). Previous iterations of the Waste Disposal Law mandated that industrial waste producers (i.e., industrial firms themselves) rather than cities were responsible for the collection, treatment, and disposal of industrial wastes and urged industrial firms to reuse their wastes. Municipalities were made responsible for planning and implementation of systems for MSW collection, treatment, and disposal. For this purpose, municipalities can enact regulations requiring waste separation and set their own fees; this power was strengthened in the 1991 amendments to the Waste Disposal Law. The Recycling Law established waste reutilization and recycling goals, using an early benchmarking system to drive municipal governments to institute supportive programs for recycling. Promotion of industrial waste reuse was strengthened at the national level with the passage of the Basic Law for Establishing the Sound Material-Cycle Economy in 2000, and a considerable number of laws regarding the recycling and reuse of specific products and materials were passed in the late 1990s and early 2000s to further promote recycling (OECD 2010).

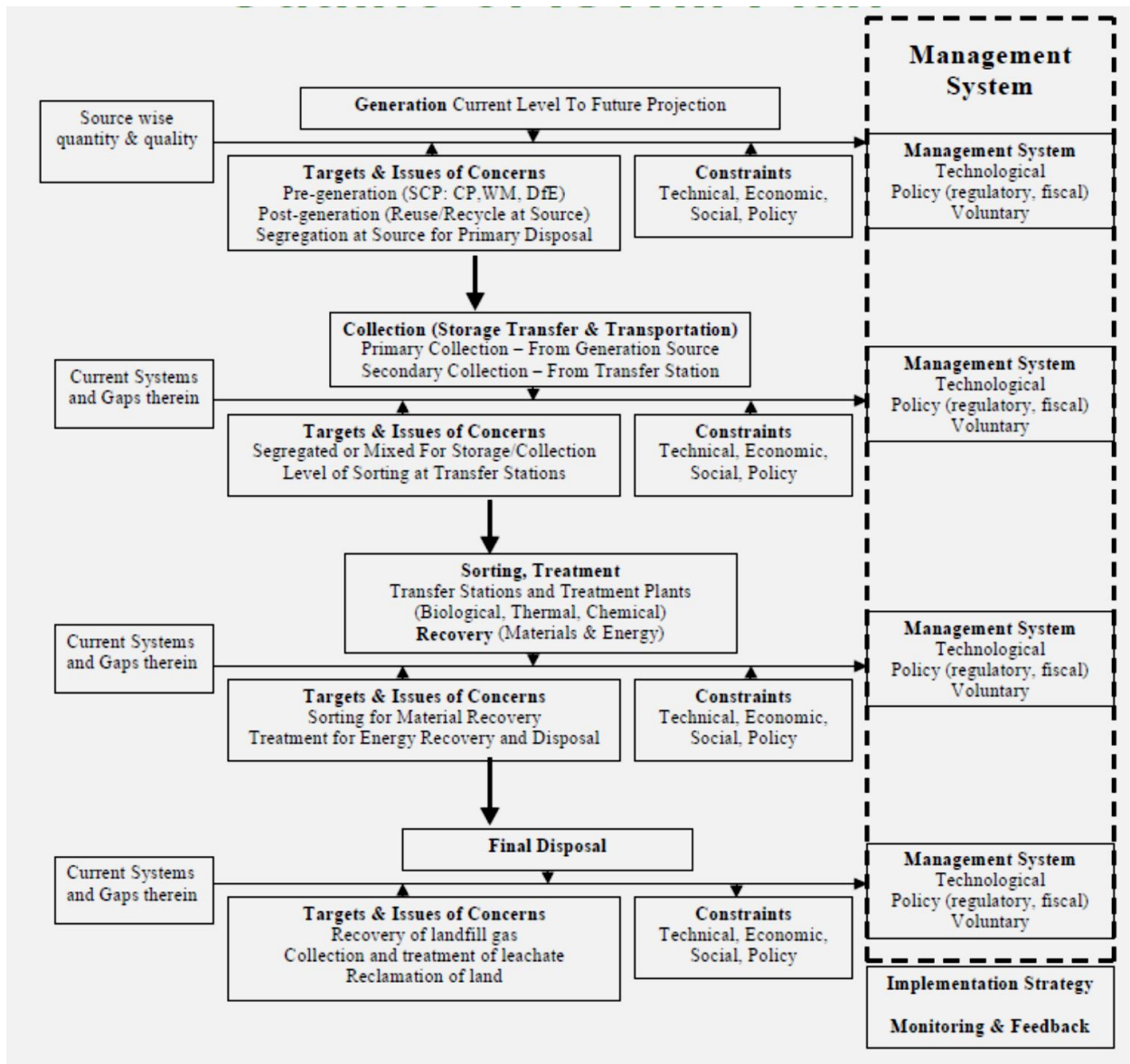

Figure 12. Outline of an Integrated Solid Waste Management Plan in Japan (Memon, no date)

Two elements of Japan’s legal framework appear to have been important to the high rates of waste recycling and advances in co-processing experienced in that country in recent years: government financing for research, development, and implementation of waste management plans and technologies; and the requirement for the standardized collection and expert analysis of waste data to identify recycling and reuse opportunities. The Waste Disposal and Public Cleansing Law amendments provide financial support for municipalities to undertake waste-related work within their jurisdictions, including establishing licensing requirements for waste treatment contractors and subsidies for the construction of general waste landfills and incinerators. Municipal regulators establish standards for the construction and operation of general waste landfills for each site, with reference to national landfill standards.

Industrial waste treatment facilities and landfill permitting are under the jurisdiction of provincial governments.

The 1991 Waste Disposal Law also had important information-gathering and dissemination consequences; it called for municipal leaders to undertake short- and long-term waste planning to be informed by comprehensive data collection, and expanded municipal government powers to require large waste generators to undertake similar planning activities. These efforts for expanded planning and data gathering took effect in amendments to the Waste Disposal Law passed in 2003, requiring new prefecture-level waste management plans.

To promote rapid development of recycling capacity, the 1991 Recycling Law required the central government to form committees to create recycling guidelines specific to individual industrial subsectors and products, with regular progress reviews. The Fundamental Plan for Establishing a Sound Material-Cycle Society, developed from legal mandates in 2003, requires the central government to develop economy-wide material flow indicators to monitor progress, with annual progress reviews and a major revision and strengthening effort in 2008. These data collection and standardization efforts, paired with the development of waste reduction promotion councils and industrial groups at the city level, have undoubtedly helped to make cement co-processing more attractive in Japan.

The MSW treatment market in Japan has been dominated by waste-to-energy schemes and simple incinerators (OECD 2010). A key to the transition from waste-to-energy incineration to cement co-processing in Japan has been linking municipal solid waste treatment facilities as well as producers of industrial wastes directly to cement facilities. These linkages have been both in the form of isolated efforts of towns interested in closing municipal solid waste incinerators as well as within districts planned specifically to optimize opportunities to reuse industrial waste streams (Taiheiyo Cement Corporation 2006; OECD 2010).

The majority of Japan's sewage sludge is incinerated, and large amounts of sewage sludge ash are used in standard Portland cement production (Ozaki & Miyamoto. No date). In addition to the use of incinerator ash for Portland cement, a Japanese cement company, Taiheiyo, has developed a specifically labeled co-processed cement product called eco-cement. Taiheiyo was the first company in Japan to investigate, during the 1990s, the chemical similarities between cement raw material inputs and MSW incineration ash. In 2001, the company opened Japan's first plant to incorporate MSW incineration ash on a large scale into eco-cement, supported by significant central government subsidies. Manufacturing the product required creating a new product standard in the Japan Industrial Standards, JIS R 5214:2002, which was accomplished in 2002 (Batelle 2002).

The eco-towns policy is the means by which cement co-processing has been directly incorporated into industrial planning policies in Japan in recent years. The eco-town concept⁶ originated through a subsidy

⁶ "Town" may be a misnomer; most eco-towns are in fact industrial parks in which large-scale industrial plants operate in close proximity and integrate waste streams.

system established by the Japanese Ministry of Economy, Trade and Industry and the Ministry of the Environment in 1997 (Global Environmental Center Foundation 2009). City governments design plans for eco-towns with local industry stakeholders; plans are verified and approved or rejected by the two ministries acting together. Once approved, projects receive considerable financial support from the ministries and are implemented by local governments and stakeholders. Subsidies range from one-third to one-half of total project costs for “hardware” projects involving the changing of machinery to increase recycling or reuse. These planning efforts can directly link industrial and municipal waste producers with cement plants and subsidize the linkage. Pursuit of eco-towns and national government subsidies resulted in the construction of a cement plant with co-processing in Kawasaki City (Hashimoto et al. 2010).

The cement industry in Japan enjoys high prices for treating wastes in co-processing plants so the cement industry has as strong presence in waste management in Japan. By 2005, Japan had 32 cement plants, with an average production capacity of 2.19 million tonnes per year. Japan has steadily increased its usage of wastes and byproducts in cement making, with about 10 percent of fuel coming from wastes in 2005. By 2009, Japanese cement plants used about 400,000 tonnes of waste plastics and nearly 500,000 tonnes of wood chips, up from 102,000 tonnes and 2,000 tonnes in 2000, respectively (Japan Cement Association, 2010).

European Union

The “polluter pays” principle described earlier is widely recognized in most of the Organization for Economic Cooperation and Development and EU countries and is stated in the Rio Declaration on Environment and Development. This principle requires that producers of wastes or pollution must be responsible for paying for resulting damage to the environment. For example, in Switzerland the waste management system is financed through the polluter pays principle in the form of Switzerland’s refuse-bag levy (Swiss Confederation, 2009).

As a result of the EU Landfill Directive, described above in Section 3.1.1, EU member states have to separate the biodegradable fraction from MSW. This is accomplished by source separation, establishment of waste-sorting plants, or diversion of wastes to other treatment methods such as co-processing (Gendebien et al. 2003).

Sorting and pre-processing of the MSW and sewage sludge is, as noted earlier, critical to the quality of the final product as well as to preventing environmental impacts. For stable operation of cement kilns, it is important that wastes have a consistent quality, including sufficient calorific value and low heavy metal content (e.g., Hg and Tl), and that it is suitable for the kiln. Unsorted municipal wastes are too heterogeneous to be used for co-processing. Combustible wastes can be separated (GTZ/Holcim 2006), and pretreated as described in the subsection above on product quality. In the European Union, waste suppliers and waste treatment facilities usually prepare the wastes and deliver them as alternative fuels to co-processing plants (CEMBUREAU, 2009).

The European Cement Association states that, after sorting, wastes to be co-processed must be free of contaminants, with a maximum of 1 percent of impurities remaining (CEMBUREAU, no date). To achieve this goal, waste separation and collection systems should be standardized. For example, in Austria, where all nine cement plants use solid wastes (recyclable plastics, paper, textiles, and composite materials), a steady supply of wastes that meet quality specifications being ensured by a collaboration of several cement working collaboratively with waste management companies to build waste pre-processing facilities (CEMBUREAU, 2009).

A list of wastes permitted for co-processing should be published by authorities, in consultation with experts and trade groups. The list should specify requirements that MSW and sewage sludge must meet to be acceptable for use as fuel in cement plants. The list should be tailored to local waste situations and reviewed periodically by authorities and experts.

In France, co-processing was first regulated under the French Waste Law, issued in 1975. Since then, “cradle-to-grave” follow-up is required for waste fuels used in cement plants. Pre-processing of the wastes was required starting in 1985 (Bernard, 2006).

Standard procedures should be developed for acceptance of waste by co-processing plants, including basic characterization of the waste, sampling, testing, and compliance testing. It is critical for co-processing plants to have a sufficient long-term supply of MSW and sludge with consistent characteristics because a steady input of wastes is needed to maintain normal kiln operations. Moreover, because cement plants might need to invest large amounts of capital to modify the material handling systems that are usually specifically designed for certain wastes, it is important to secure the supply of wastes to justify this expenditure.

3.4. Permitting and Performance Approval

European Union

The EU legislation requires facilities that intend to conduct waste treatment to obtain a government permit. The permit determines the categories and quantities of wastes that can be treated, technical requirements for using the wastes, safety and precautionary measures, the plant’s co-processing capacity, and information and procedures for sampling, measuring, and controlling pollutants. The EU Directives also require that co-processing plants be operated at a high level of energy efficiency (EC, 2012e). Permits have a duration of 3 or 5 years. Implementation of the permits entails member states or “competent authorities” establishing specific requirements based on local conditions (EC, 2011a).

To avoid duplicate efforts, permits can be used for multiple purposes, for example regulating air and water pollutants as well as other environmental impacts. Permits can be refused if authorities consider the proposed waste treatment method does not adequately protect human health and the environment. The permit process has several stages: application, assessment, issuance, follow-up, and training/guidance/networking, as illustrated in Figure 13.

In most EU member states, co-processing plants must apply for waste/ environmental permits. In some countries, co-processing plants must apply for IPPC permits (UK), or licenses (Germany). Environmental assessments and public consultation are required in the UK and Spain (Gendebien et al. 2003), and, in some other European countries, simplified permitting procedures (e.g., in Italy), or specific regulations (such as in Portugal) have been adopted to promote the use of MSW and sewage sludge in co-processing plants (Gendebien et al. 2003).

In the UK, the permit regulators require co-processing plant operators to submit periodic reports on emission performance. Any violation of the emissions limit must be reported to the regulator within 24 hours. Regulators also inspect co-processing plants, including checking on operational details and monitoring equipment and emissions levels. Co-processing plants face penalties for non-compliance, ranging from criminal prosecution to fines and/or imprisonment of responsible individuals (Defra, 2006).

In Germany, cement kilns are regulated by Federal Emission Control Act, which is the basis for comprehensive regulations on air quality, noise abatement, and plant safety. The emissions limits on exhaust gas from cement plants are regulated by the Technical Instructions on Air Quality Control, and waste fuels are regulated by the Ordinance on Incineration Plants Burning Wastes and Similar Substances, which is based on EU Directive 2000/76/EC.

Germany's Federal Emission Protection Act requires an environmental compatibility test for any co-processing projects that could have negative impacts on people, animals or plant life, soil, water, air, the climate, or the landscape, as well as any interactive effects. When applying for licensing, a cement plant is required to supply the following information regarding use of waste fuels (Bolwerk, no date and GTZ/Holcim 2006):

- Topographical map
- Construction documents
- Description of normal plant operations
- Description and assessment of the production process in which waste fuel would be used
- Proof that the plant is designated as a specialized waste disposal plant for the processing of residual materials
- Proof that the plant is suitable for co-processing
- Documentation of every single inorganic and organic constituent of the wastes to be used and the finished mixture of secondary waste fuels
- Description of emissions prevention methods
- Documentation of air pollution emissions (NO_x, SO₂, dioxins/furans, dust, heavy metals)
- Documentation of health and safety standards
- Documentation of energy-saving measures

Operational requirements are also assessed during the licensing process, and information on the following items is required (IMPEL Network, 1998):

- Calorific value and added quantity of substitute fuel

- Pollutant content (polychlorinated biphenols, heavy metals, etc.)
- Identity of the waste materials used
- Chemical, physical-chemical, toxic, and ecotoxic properties of the materials
- Combustion conditions and destruction efficiency
- Recirculation systems that reduce environmental emissions
- Possible ways of purging and relieving recirculation systems
- Operating processes with cut-offs (CO cut-off)
- Effect and type of exhaust gas cleaning processes

Access to permit information is important so that other related governmental agencies and the public can participate and monitor plant performance. In addition to paper documentation, electronic reporting and databases can be used. Databases can be designed to provide access (with differing degrees of restriction) to the general public, local authorities, central/regional governments, and other organizations. The EU WID requires that all new permit applications must be made available to the public for comment before the local authorities reach decisions (EC, 2011a).

United States

Before being amended in 1990, the U.S. Clean Air Act (Section 165) required only new or modified stationary sources to obtain construction permits. However, the Clean Air Act Amendments of 1990 added Title V, which requires states to administer a comprehensive permitting program for sources emitting air pollutants.

U.S. cement plant permits are issued by state regulatory agencies implementing Clean Air Act programs. Cement plants generally operate under a Clean Air Act Title V Operating Permit (EPA, 2008). Permit conditions include:

- Emissions limits for key air pollutants, e.g., NO_x, CO, SO₂, PM, and HAPs
- Emissions of substances regulated by MACT Standard 40 CFR 63 Subpart LLL, including PCDD/PCDFs, PM, Hg, and total hydrocarbons

States collect annual fees from emissions sources to cover the “reasonable costs” of administering the permit program, with revenues to be used to support agency air pollution control programs (McCarthy, 2005). Fees must be at least \$25 per ton of regulated pollutants (excluding CO) (McCarthy, 2005). Authorities may choose not to collect fees on emissions in excess of 4,000 tons per year, and may collect other fee amounts.

Permits specify air pollutant emissions limits. Co-processing facilities must prepare permit compliance plans and certify compliance. Permit terms are limited to a maximum of 5 years and must be renewed. State authorities submit permit applications to U.S. EPA for review (McCarthy, 2005).

Co-processing cement plants in the United States must also obtain construction permits to use a new alternative fuel (including MSW and sewage sludge), in part because of capital expenditures for required

modifications to plant materials handling systems. Co-processing cement plants are usually required to conduct air emissions performance testing to demonstrate that the use of alternative fuels/raw materials will not increase the air emissions (U.S. EPA, 2008).

Short-term permits are usually granted to conduct this performance testing, which allows the plants to investigate both the technical performance of the alternative fuel as well as the economic and technical feasibility of using the fuel. Several U.S. regulatory agencies have reported cement plants that ended up not using the alternative fuels after testing because of technical difficulties rather than because of issues related to air emissions (U.S. EPA, 2008). In the United States, co-processing plants sometimes need to obtain other state permits, such as permits for solid waste facility. However, not every modification in plant process or every new use of alternative fuel needs to be permitted (U.S. EPA, 2008).

Brazil

As of 2007, Brazil was using alternative fuels for about 23 percent of its cement production energy needs (Inter-American Development Bank, 2010). The country's first experience with waste-derived fuels in cement plants was in the early 1990s. Initially, co-processing was unregulated, but the state environmental agencies subsequently collaborated with cement industry representatives to formulate a framework of emissions standards and burn tests for plants to receive waste incineration permits (Marigold, 2007). By 1998, Brazil's industrialized southern states (Minas Gerais, Sao Paulo, Rio de Janeiro, Parana, and Rio Grande do Sul), where 65 percent of the country's cement is produced, had promulgated their own regulations for co-processing wastes (Maringolo, 2007). It is estimated that about 80 percent of Brazil's 65 cement plants have substituted waste for either fuel or raw material inputs or both (Busato, no date).

In 1999, the Brazilian federal environmental agency promulgated the national Regulatory Act No. 264/99 "Cement Kilns – Permitting for Waste Co-processing Activities." Regulation 264/99 establishes technical and operational criteria, emissions limits, and pre-permit testing requirements for co-processing permits for cement kilns (Maringolo, 2007). The regulation applies to all wastes except gross domestic wastes and hazardous wastes such as radioactive, explosive, health services, and organochlorine pesticide wastes. In addition, co-processing plants must prove that the waste is entering the kiln as a substitute for either fossil fuels or natural raw materials, that the supply of waste is steady and consistent, and that the co-processed clinker will not leach dangerous metals to the environment.

Regulation 264/99 specifies several steps to acquire a co-processing permit; each step has comprehensive documentation requirements. An initial treatment feasibility study must document the following: general cement plant data; data on raw materials and final fuel characteristics (calorific value, viscosity for liquids, heavy metals content, ash and moisture, and classification according to Brazilian classification standards) used in the plant; a description of the process and equipment used, including flow charts; and a description of pollution control equipment. A "blank test plan" must then be prepared to benchmark pollution levels from the plant without co-processing and to indicate pollution control technologies, detection limits, and self-monitoring protocols, as well as expected emissions and waste dust composition. A test firing plan is the next requirement, which documents: the origins and

specifications of all equipment, fuels, and feed streams to be used in co-processing; monitoring systems; expected emissions and outcomes; and the professional certifications of all technicians involved with the testing. A pre-test burn may be authorized to work out issues prior to the official test.

Several specific emissions parameters are given for elemental emissions and organic hazardous compounds. These parameters can be made stricter by local environmental authorities based on ambient air quality. In addition to this, National Regulatory Act 316/02, Licensing of Incineration/Co-incineration, establishes limits for emissions of dioxins and furans (0.5 nanograms per cubic nanometer [ng/Nm^3] from cement kiln co-processing. The character of the waste fuels must be thoroughly documented, and waste-to-fuel producers are covered by separate regulations. Fuels themselves may also be regulated more stringently by states; for example, in 2010, Minas Gerais state approved a new regulation for waste co-processing in cement kilns that established a minimum calorific value for used wastes (1,500 kilocalories/kg for MSW) (Kihara, 2012). In 2010, Brazil passed the National Solid Waste Policy (No. 12.305/2010), which is intended to standardize waste policy among Brazil's 26 states and calls for dramatic reductions in landfill disposal. In particular, the national policy supports implementation of waste-hierarchy-based local-level waste planning and pushes the expansion of waste recovery from MSW, including processing (Article 9, paragraph 1). The policy will be implemented over the next 5 years.

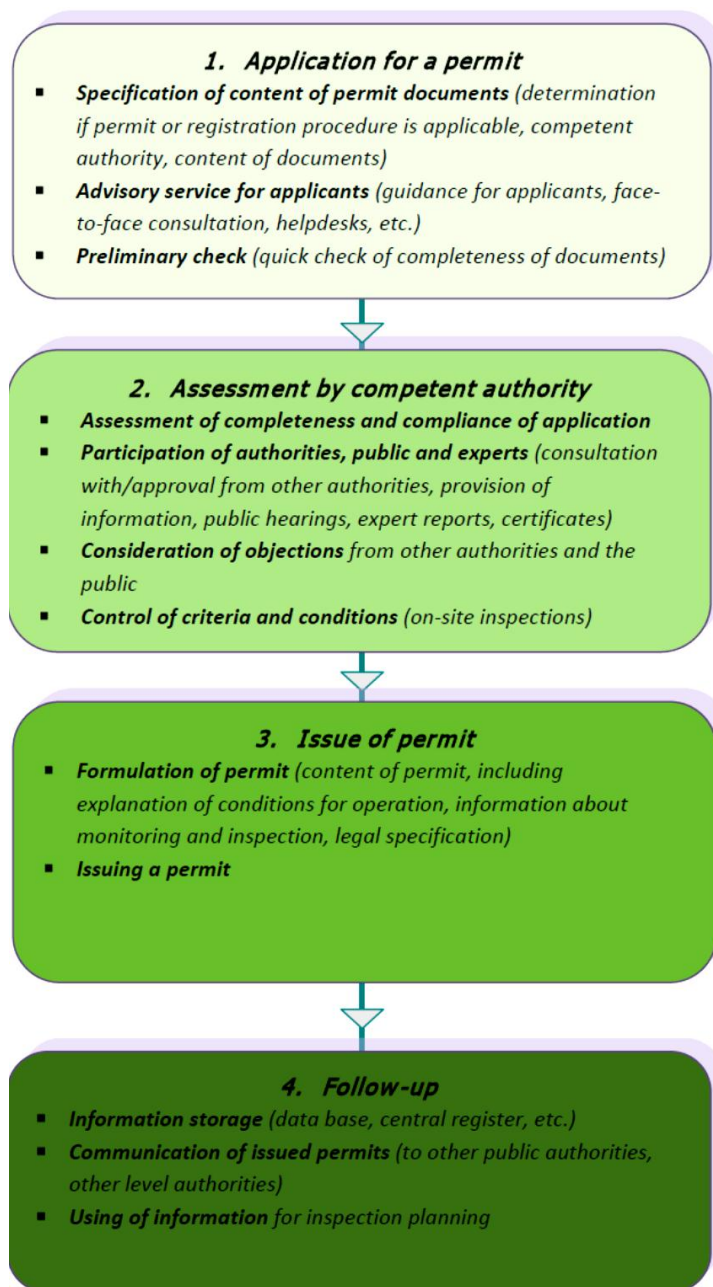

Figure 13. Key Stages in Issuing Co-Processing Permits in Brazil (Milieu, 2011)

3.5. Monitoring System Requirements

Best monitoring practices for co-processing plants include: standard measurement methods, certified instruments, certification of personnel, and accredited laboratories. Monitoring of co-processing plants has three elements: processing monitoring, emissions monitoring, and environmental monitoring (EIPPCB, 2003).

European Union

The EU waste incineration directive requires co-processing plants to install emissions and combustion measurement and monitoring systems. Air emissions and water discharges must be measured either continuously or periodically (EC, 2011a). The following parameters should be monitored continuously: NO_x, CO, total dust, TOC, HCl, HF, SO₂, temperature of the combustion chamber, concentration of oxygen, pressure, and temperature and water vapor content of the exhaust gas. Periodic monitoring is required for the following substances: metals, semi-metals and their compounds, total organic substances, PCDDs/PCDFs. For plants that have a nominal capacity of 2 tonnes or more per hour, operators provide annual reports on plant functioning and monitoring. The annual reports are also made available to the public. Local authorities make public a list of plants that have a nominal capacity of less than 2 tonnes per hour (EC, 2011a).

Facilities in the European Union have to submit key environmental data to the European Pollutant Release and Transfer Register (E-PRTR) (E-PRTR, 2011). E-PRTR replaces the previous European Pollutant Emission Register (EPER) system for environmental reporting and contains annual data reported by approximately 24,000 industrial facilities covering 65 sectors in Europe, including cement industry co-processing plants. Each facility provides information on the quantity of pollutants released to air, water, and land; as well as offsite transfers of waste. E-PRTR aims to increase transparency and public participation in the environmental decision-making process. In Germany, this regulation was implemented with the PRTR Act (SchadRegProtAG) (VDZ, 2010).

EU legislation also requires co-processing plants to submit annual reports on their functioning and monitoring, including descriptions of the plants' general process, emissions to air and water, and comparison of the plant's emissions to the applicable emissions standard. Many EU member states also require plants to submit information on the types of waste co-processed and the capacity of the installation. EU legislation requires member states to report to the European Commission every 1 or 2 years. The European Commission uses a standard questionnaire (EC, 2006a) for member states to report the status of their waste incineration and co-incineration plants, including co-processing plants.

The UK uses the Operator Pollution and Risk Appraisal scheme to assess the environmental performance of cement plants. In 2004, 11 cement plants (85 percent of the total in the country) achieved an "excellent" score for operator performance, compared to 44 percent of all of British industry. All cement plants must have a formal environmental management system in place. All have ISO 14001 certification, and 10 are registered to the EU Eco-Management and Audit Scheme. All cement plant parent companies in England and Wales produce a sustainability or environmental report. In January 2008, Lafarge Cement UK was the first manufacturer to apply for permission to trail a waste derived fuel, which was produced from paper, plastics and some domestic refuse, under a new code of practice agreed with the UK Environment Agency. The permission was granted in April 2008, and the trail was successfully trailed. CEMEX completed two trails of using solid recovered fuel and received the permit to use this fuel at all of its UK cement plants. In each trail, more than 10,000 tonnes of waste were used in cement-making. By 2008, the UK cement industry has achieved an overall of 26.5% replacement of fossil fuels by waste-derived materials (MPA Cement, 2009). To monitor environmental releases from using sewage sludge, the cement sector in Catalonia, Spain signed an agreement in 2005 with the Catalan administration,

trade unions, and local councils, and piloted the monitoring of the environmental impacts of using dried sewage sludge in cement plants (CEMBUREAU, 2009).

United States

The U.S. EPA established regulations to monitor air emissions (i.e., PM, NO_x, and SO₂) from cement kilns through the agency's fence-line monitoring program. Each owner or operator of a cement plant in the United States that is required to install a continuous opacity monitoring system is also required to submit semiannual reports of excess emissions. Under the delayed CISWI Standards, all cement plants treating nonhazardous solid waste are required to demonstrate initial compliance with emissions limits. Existing facilities must annually inspect scrubbers, fabric filters, and other air pollution control devices.

Parametric monitoring and bag Pb detection is also required if applicable. CEMS are required to monitor Hg, PM, and HCl, and annual testing is required for SO₂, NO_x, CO, Pb, Cd, PCDDs and PCDFs. For new cement co-processing facilities, the monitoring requirements are the same as for existing units, but the rule also requires CEMS for CO, SO₂ and NO_x.

Emissions and other compliance data are necessary for U.S. EPA review the MACT and CISWI standards, determine compliance, develop emissions factors, and determine annual emissions rates. To reduce costs and administrative burden on both regulators and plant operators, U.S. EPA receives stack test reports in electronic format rather than on paper. Operators of co-processing cement plants must submit performance test data through the Electronic Reporting Tool (ERT). ERT provides a standardized means of compiling and storing required documentation and significantly reduces the effort involved in collecting data for future activities, such as risk assessments. ERT is connected to U.S. EPA's electronic emissions database (WebFIRE) (EPA, 2012c), which was constructed to store emissions test data for use in developing emissions factors. Thus, cement plant operators can use ERT to collect and prepare data and documentation and can submit data through U.S. EPA's Central Data Exchange network for storage in the WebFIRE database.

3.6. Enforcement of Regulations

Enforcement of regulations and standards is key for a successful, environmentally safe co-processing industry. Enforcement of regulations and standards can also ensure the financing and marketing of co-processing.

European Union

In the European Union, member states must report to the European Commission every 1 or 2 years regarding achievement of waste management system targets. Reports are sent 18 months after the end of the reporting period. The commission then must report to the European Parliament and Council on the application of the WID. Plants that violate the IPPC Directive face administrative sanctions.

United States

In the United States, Section 113 of the Clean Air Act establishes federal authority to issue agency and court orders requiring compliance with the act and to impose penalties for violations. Section 114

authorizes U.S. EPA to require emissions sources to monitor emissions, certify compliance, and submit reports and authorizes U.S. EPA personnel to conduct inspections. The Clean Air Act is enforced primarily by state or local governments, which issue permits, monitor compliance, and conduct the majority of inspections.

In 2008-2010, U.S. EPA established the national “New Source Review/Prevention of Significant Deterioration (NSR/PSD)” enforcement initiative for the cement industry. The initiative was continued in the form of the national initiative “Reducing Air Pollution from the Largest Sources” for the years 2011-2013 (U.S. EPA, 2011g). U.S. EPA’s Office of Enforcement and Compliance Assurance promotes compliance and works with EPA’s regional offices and in partnership with state governments as well as other federal agencies to enforce environmental regulations. During fiscal year 2010, U.S. EPA initiated investigations/negotiations with 85 percent of the U.S. cement sector (U.S. EPA, 2011h). The main enforcement strategy used by the Office of Enforcement and Compliance Assurance is compliance investigation and evaluation. The primary forms of compliance investigations are (U.S. EPA, 2009):

- Written information requests
- State/local permit file reviews
- Regional file reviews
- Public information reviews
- Onsite compliance inspections
- Source emissions testing information requests
- Notices of violation
- Administrative orders, administrative penalty orders, or case referrals to the Department of Justice
- Support of referred claims
- Development of cases for filing
- Training of regional personnel to increase awareness of investigatory techniques

Clean Air Act violations can be charged as misdemeanors or felonies. Penalties for violating emission requirements may be up to \$27,500 per day (U.S. EPA, 2010). U.S. EPA also has the authority to assess administrative penalties and authorizes \$10,000 awards to persons supplying information leading to convictions under the act. Under the 2011 CISWI Standards (whose effective date has been delayed), new nonhazardous solid waste treating cement plants must demonstrate compliance with emission limits within 60 days after the kilns reach the operational charge rate and no later than 180 days after initial startup. Existing units must demonstrate compliance with emission limits “as expeditiously as practicable” and no later than 3 years after approval of a state plan or 5 years after promulgation of the 2011 CISWI Standards. States are responsible for establishing procedures and measures for implementing the U.S. EPA rules. State implementation plans must include emissions limits and other requirements for both new and existing units and must be submitted to U.S. EPA for review.

4. Technological Aspects of Co-processing – International Best Practices

Co-processing entails a number of technological elements, including pre-processing and treatment of wastes so that they are in a usable form for burning in cement kilns. A number of retrofits are required to enable co-processing at plant sites, and new installations and technologies for storage, conveyance, dosing, feeding, and final treatment of MSW and sewage sludge as well as measurement and control of emissions are often required (ALF-CEMIND 2012).

The subsections below describe technologies used in different stages of pre- and co-processing of MSW and sewage sludge. The “operational aspects” of co-processing are not addressed in this report; for more information about operational aspects, see GTZ/Holcim (2006), WBCSD (2005), and EIPPCB (2006).

4.1. Pre-processing Technologies and Practices

Waste materials used for co-processing in the cement industry are derived from selected waste streams. As noted earlier, wastes usually require pretreatment (e.g., dewatering, drying, shredding, blending, grinding, homogenization, etc.) and quality assurance (CEMBUREAU 2009). Mixed municipal waste must be pre-processed in waste management facilities. The extent of the waste pre-processing depends on the source and type of the waste and on cement industry requirements (EIPPCB 2010).

4.1.1. Pre-processing technologies and practices for MSW

MSW is a heterogeneous mixture of materials. Pre-processing helps to make a more homogeneous fuel (RDF) and should be part of integrated MSW management systems. Figure 14 shows an example of integrated MSW management (GTZ/Holcim 2010). The important characteristics of RDF as a fuel are the calorific value, water content, ash content, and sulphur and chlorine content. These values depend on the composition of the waste, which depends on the region of origin and varies according to the sources (e.g., households, offices, construction sites), seasons, the collection system (mixed MSW, source separated), and the pre-processing techniques applied (screening, sorting, grinding, drying) (ALF-CEMIND 2012).

There are various pre-processing methods for MSW. One common practice in developed countries is to use mechanical biological treatment (MBT) on raw municipal solid waste to be used in the cement industry (ALF-CEMIND 2012). MBT is discussed in detail below.

Mechanical biological treatment

MBT is a generic term for an integration of several processes that are commonly part of other waste management techniques (Defra 2007). The main purpose of MBT is to prepare a combustible material (RDF) from MSW. During this procedure, raw MSW is screened and separated to recover discrete recyclable materials such as metals, plastics, sizable pieces of cardboard, aluminum cans, and other material that can be reused. The remaining material, which consists largely of organic components

such as plastics and biodegradable waste, is shredded to desirable sizes, producing the RDF for use as fuel in cement plants (Figure 15) (ALF-CEMIND 2012).

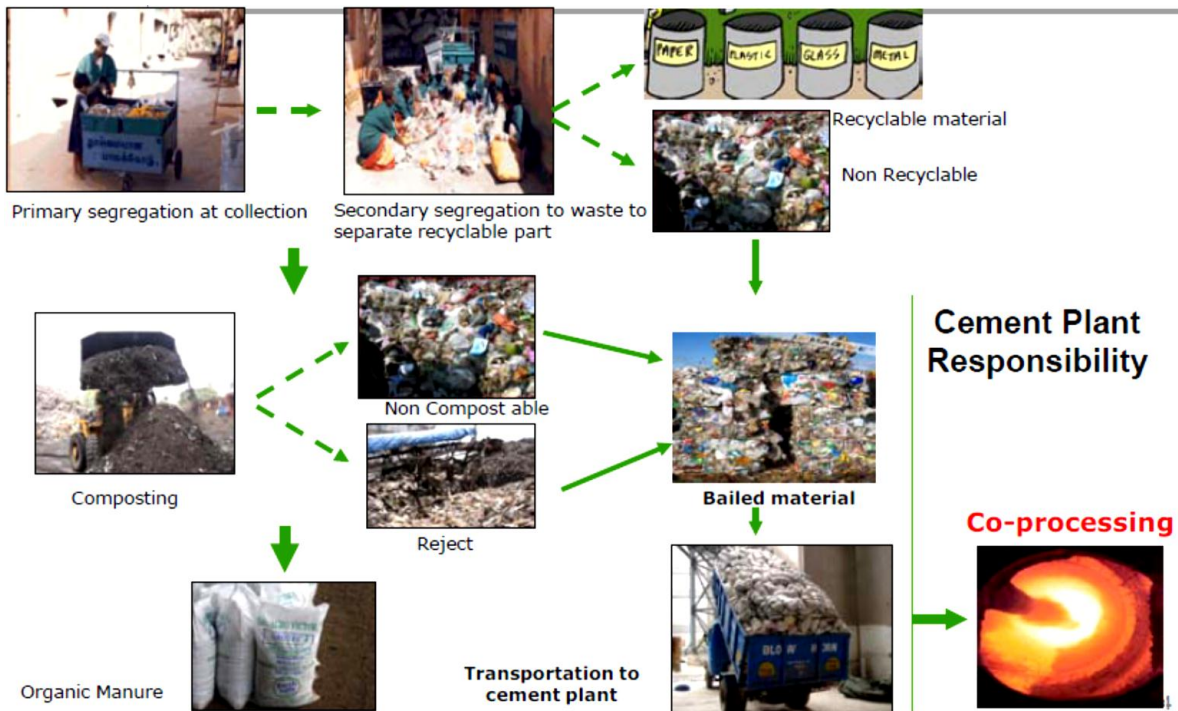

Figure 14. An example of integrated MSW management (GTZ/Holcim 2010)

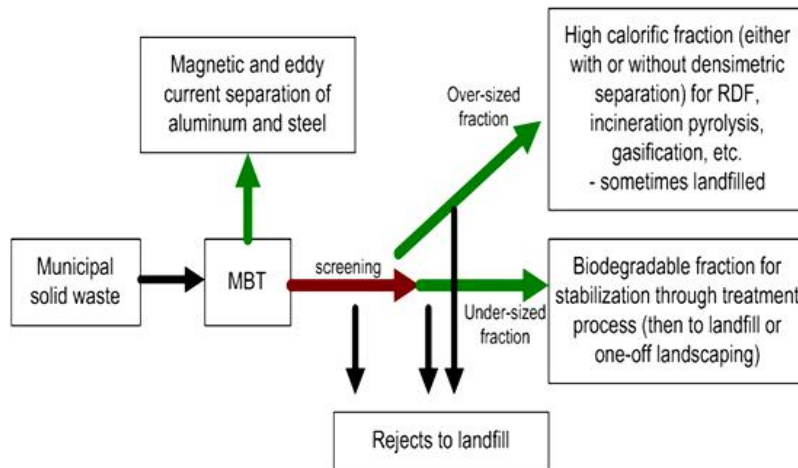

Figure 15. An example of the MBT for RDF production (ALF-CEMIND 2012)

On average, MBT of 1 tonne of municipal solid waste yields about 250 kg of RDF. Some country-specific values are: Austria 230 kg (MBT), Belgium 400-500 kg (MBT), the Netherlands 350 kg (Mechanical treatment), and UK 220-500 kg (Mechanical treatment) (ALF-CEMIND 2012).

Figure 16 shows flow diagrams of the main MBT configurations. The simplified dry stabilization technique on the right hand side can be an option to introduce MBT in emerging countries that have a large amount of organic matter in their MSW. This technique is currently being used in Thailand by the Thai-German Solid Waste Management Project (Seemann 2007).

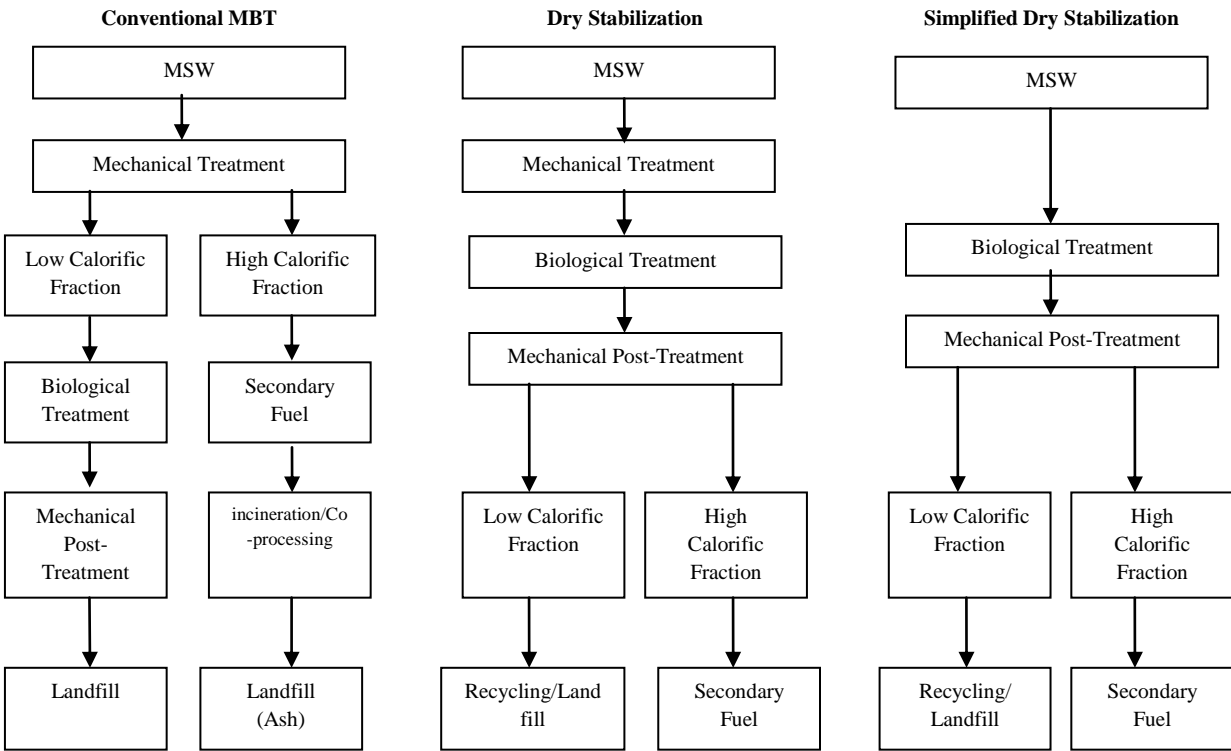

Figure 16. Flow Diagrams for Primary MBT Configurations (Seemann 2007)

MBT is commonly used for nonhazardous waste, such as MSW, commercial waste, and construction and demolition waste. The most common waste materials treated in this fashion are paper, plastic, wood, and textiles. Two major fuel types are produced by MBT: shredded or fluff-like material and densified fuels, such as pellets, cubes, and briquettes. Densified recovered solid fuel can have net calorific values up to 30 MJ/kg depending on composition. The reported minimum calorific values vary from 3 to 40 MJ/kg (EIPPCB 2006).

Individual process units in RDF production lines

RDF production lines consist of several units that separate unwanted components and condition combustible matter to achieve required fuel characteristics. Typical process units separate waste, reduce its particle size, and dry and densify it. These units can be arranged in different sequences depending on the composition of the MSW and the required quality of the RDF. Each type of RDF process unit is explained briefly below (Nithikul 2007).

Waste separation

The separation unit picks out different materials that are suitable for different end uses. Potential end uses include recycling, biological treatment, energy recovery through production of RDF, and landfill. A variety of techniques can be employed to separate waste (see Table 11). Most waste treatment facilities use a combination of several techniques. Waste separation technologies use certain properties of the materials in the waste (size, shape, etc.). Some commonly used waste separation techniques are briefly explained below. Table 13 presents the typical power requirements and capital and operational costs of several of these technologies, based on a study in Italy (Caputo and Pelagagge 2002).

Table 11. MSW Separation Techniques (Defra 2007)

Separation Technique	Separation Property	Materials targeted
Manual Separation	Visible identifying characteristics	Plastics, contaminants, oversize
Trommels and Screens	Size	Oversize – paper, plastic Small – organics, glass, fines
Magnetic Separation	Magnetic	Ferrous metals
Eddy Current Separation	Electrical Conductivity	Non-ferrous metals
Wet Separation Technology	Differential Densities	Float - plastics, organics Sink - stones, glass
Air Classification	Weight	Light – plastics, paper Heavy – stones, glass
Ballistic Separation	Density and Elasticity	Light – plastics, paper Heavy – stones, glass
Optical Separation	Diffraction	Specific plastic polymers

Manual separation. Often the first step in MSW treatment is manual sorting. Bulky items such as appliances, furniture, etc. as well as specified contaminants (e.g., hazardous waste) can be removed from mixed MSW manually by workers. Manual sorting also entails recycling paper, glass/plastic containers and aluminum cans. Equipment involved in manual separation usually includes a sorting belt or table (Nithikul 2007).

Trommel screen. A trommel is a rotary, cylindrical screen that inclines downward (Figure 17). The screening surface is either wire mesh or perforated plate. It can be used for mixed MSW prior to size reduction (pre-trommeling) or after shredding (post-trommeling). Trommel screens have proven to be quite effective and efficient for processing mixed MSW and are commonly used (Nithikul 2007).



Figure 17. Trommel screen (Doppstadt US 2012)

Magnetic separation. Magnetic separation segregates ferrous metals from MSW. Three configurations of magnetic separators are the magnetic head pulley, magnetic drum, and magnetic belt. The magnetic metal recovery per unit weight of total magnetic metal in MSW is about 80 percent for a single stage of magnets. A higher rate of recovery can be achieved using multiple-stage magnetic separation. If an air classifier (see below) is used before the magnetic separator, this can increase the recovery rate to as much as 85 to 90 percent because the air classifier removes lightweight contaminants such as paper and plastic, which interfere with the magnetic separation process (Nithikul 2007).

Air classification. Air classification relies on the differences in aerodynamic characteristics of waste. The process consists of the interaction among a moving stream of air, shredded wastes, and gravitational force. The fraction of MSW that is suspended in the air stream is referred to as the light fraction (e.g., paper and plastic), and the materials that settle are referred to as the heavy fraction (e.g., metals and glass). There are different types of air classifiers for different airflow patterns (Nithikul 2007).

Disc screen. Disc screens are often used to separate the inorganic fraction of waste. A disc screen consists of evenly spaced shafts in a horizontal plane fitted with discs. The openings between the discs allow undersized particles to fall through. All shafts rotate in the same direction and carry the wastes from one end to another (Nithikul 2007).

Waste size reduction

Size reduction (sometimes called shredding or grinding) is an essential operation in mechanical pre-processing of MSW because it results in a degree of size uniformity. Shredding of mixed waste to about 10 centimeters is common in many waste treatment facilities. Additional shredding steps might be required to produce RDF that is smaller than 10 centimeters (Defra 2007).

Table 12 presents different size reduction techniques and tools that are applicable to MSW. Two are prominently used in the management of MSW: high-speed, low-torque hammermills and low-speed, high-torque shear shredders, which are based on different principles and have advantages and disadvantages (Fitzgerald and Themelis 2009). Hammermills and shredders are discussed briefly below.

The typical power requirement and capital and operational cost of these technologies are presented in Table 13 based on a study in Italy (Caputo and Pelagagge 2002).

Energy consumption is an important economic factor in the use of size reduction equipment. The required final size of the waste affects the energy intensity of the size reduction equipment; the smaller the final size, the more energy is required to process the waste. Figure 18 illustrates an example of decreasing final product size corresponding with increasing specific energy requirements for size reduction equipment.

Hammermills. There are two types of hammermills: horizontal rotor and vertical rotor. The horizontal hammermill is commonly used for mixed MSW. It consists of a shaft, hammer, grates, breaker bars, and hinged rejection chute (Figure 19). Wastes are fed into the opening of the machine and interact with the hammers and each other until reduced to a size that can pass through the grates (Nithikul 2007). Hammermills are available in a wide range of sizes and capacities; some can process up to 300 tons per hour of MSW. Capacity depends on the desired final particle size as well as the content of the raw waste. A realistic value for continuous operation of larger hammermills peaks at about 150 t/h. Hammermill specific energy consumption ranges from 6 to 22 kWh/t waste (Fitzgerald and Themelis 2009).

Table 12. MSW size reduction techniques (Defra 2007)

Tool	Technique	Key Concerns
Hammermill	Swinging steel hammers significantly reduce size of material.	Wear on hammers, pulverizing and "loss" of glass / aggregate
Shredder	Rotating knives or hooks turn at a slow speed with high torque. The shearing action tears or cuts most materials.	Damage to shredder from large, strong objects
Rotating Drum	Material is lifted up the sides of a rotating drum and then dropped back into the center. Gravity tumbles, mixes, and homogenizes the wastes. Dense, abrasive items such as glass or metal will help break down the softer materials, resulting in considerable reduction in size of paper and other biodegradable materials.	High moisture of feedstock can be a problem
Ball Mill	Rotating drum uses heavy balls to break up or pulverize the waste.	Wear on balls, pulverizing and "loss" of glass / aggregates
Wet Rotating Drum with Knives	Waste is wetted, forming heavy lumps that break against the knives when tumbled in the drum.	Relatively low size reduction. Potential for damage from large containers
Bag Splitter	This gentle shredder is used to split plastic bags while leaving the majority of the waste intact.	No size reduction; splitter may be damaged by large, strong objects.

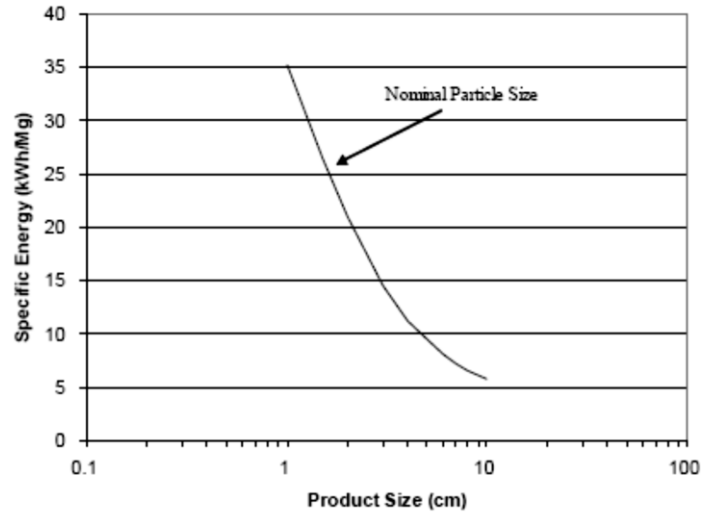

Figure 18. Specific energy requirements for MSW size reduction (Nithikul 2007)

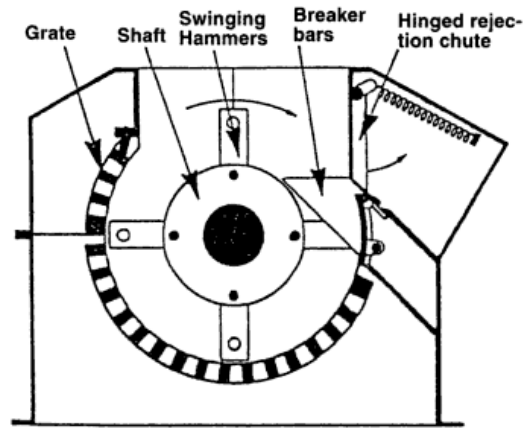

Figure 19. Schematic of horizontal hammermill (Bilitewski et al. 1997)

Shredder. A shredder operates at high torque and low speed (between 10 and 50 rotations per minute [rpm]). Shredders rely on cutting and tearing forces; little or no impact is involved. Shredders are made in single-, double-, or quadruple-shaft configurations. Increased shaft numbers produce a smaller final particle size (Figure 20). The counter-rotating shafts are fitted with cutting knives that intermesh and create large shear forces on any material trapped between them. The capacity of a shredder depends on the rotor speed and the volume between cutting knives. Available industrial shredders have capacities up to around 70 t/h. Shredder-specific energy consumption ranges from 3 to 11 kWh/t (Fitzgerald and Themelis 2009). Because of their high torque and shearing action, shredders are commonly used for materials that are difficult to shred such as tires, aluminum, and plastic (Nithikul 2007).

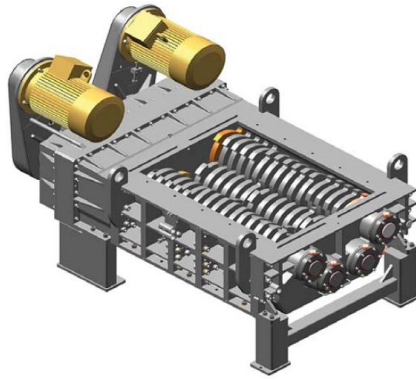

Figure 20. A schematic of a MSW shredder (Fitzgerald and Themelis 2009)

Drying and densification

Drying and densification are used to produce RDF as well as to reduce the volume of waste prior to landfilling. The objective of this process is to improve the quality of RDF. Densification produces briquettes, pellets, or cubes (Nithikul 2007). Depending on the water content and the physical characteristics of the waste, a dewatering process can be applied before drying. Dewatering techniques include: gravity thickening, centrifugal thickening, flotation thickening, and gravity belt and rotary drum thickening.

Different types of technologies are used to dry waste. Waste drying technologies can be classified as follows (Schu 2008):

- Biological dry stabilize processing (untreated MSW- shredded < 200 millimeters [mm])
- Thermal drying
 - Drum dryer (treated MSW - sieved/shredded < 60 mm)
 - Belt dryer (treated MSW- sieved/shredded < 40 mm)
 - Tunnel dryer (MSW- sieved 40 - 400 mm) (Figure 21)

Biological drying uses the intrinsic heat of the waste mixture in combination with forced ventilation and energy recirculation from a heat exchanger. Energy for drying is generated primarily by microbial processes that oxidize organic substances contained in the waste. Disadvantages of this method are a high volume of extracted airflow and a long drying period of 7 to 10 days. Also, fractions of the MSW that have high calorific value do not contain enough biogenous material for this drying method. Therefore, often, thermal drying is preferred over biological drying for waste (Schu 2008).

Thermal drying uses convection or conduction dryers. In convection (direct or adiabatic) dryers, there is direct contact between the heating medium (e.g. hot air) and the product to be dried, which removes moisture from the waste. In conduction dryers, there is no direct contact between the heating medium and the product. Heat transfer takes place through contact between the waste and a heated surface, and moisture is removed by a carrier gas or air. Conduction dryers use approximately 10 percent of the gas

used in convective dryers. Therefore, conduction dryers may be preferable for dusty or odorous wastes since they have lower amount of exhaust gas compared to the convective dryers. (EIPPCB 2006).

Table 13 shows the typical power requirements and capital and operational costs of thermal drying and densification of MSW based on a study done in Italy (it is not clear what type of dryer was used in that study) (Caputo and Pelagagge 2002).

Cost of RDF production

Cost of RDF production depends on the line configuration of the size reduction, densification, and drying equipment; that configuration is determined at least in part by the desired RDF quality. Caputo and Pelagagge (2001) show that different configurations of the RDF production line affect the final cost per tonne of RDF produced (Caputo and Pelagagge 2002). Table 13 shows an example of estimated costs for different RDF production units in Italy. Appendix 4 presents the performance and total cost of different configurations of RDF production lines in Italy, as estimated by Caputo and Pelagagge (2001).

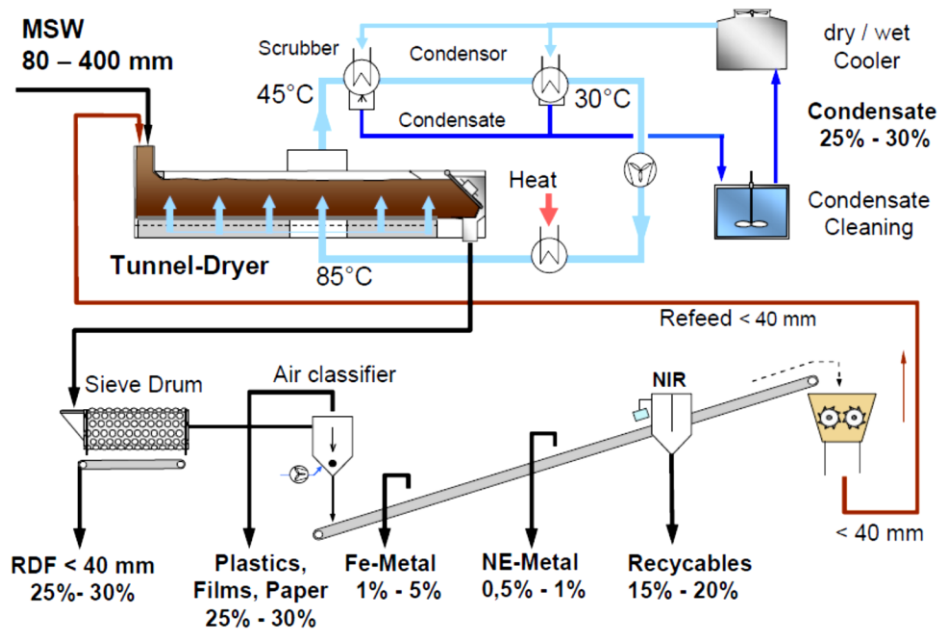

Figure 21. Process flow diagram for a low-temperature tunnel dryer (Schu 2008)

Table 13. RDF production line equipment cost (Caputo and Pelagagge 2002)

Equipment	Capacity (t/h)	Power (kW)	Cost (kEuro)	Amortization (Euro/h)	Operating cost (Euro/h)
Densifier	6	5	206.58	4.73	3.62
Air classifier	5	12	41.31	0.95	0.87
Dryer	6	140	309.87	7.09	10.12
Belt conveyor		6	15.49	0.35	0.43
Hammer mill	2	200	129.11	2.96	14.46
	4	250	144.60	3.31	18.08
	6	300	154.93	3.55	21.69
Pelletizer	4	50	206.58	4.73	3.62
Eddy current separator	5	2.2	7.23	0.83	0.27
	10	2.2	11.87	0.96	0.45
	15	2.2	14.97	1.14	0.48
Magnetic separator	5	3.75	36.15	0.17	0.16
	10	6.25	41.83	0.27	0.16
	15	6.6	49.57	0.34	0.16
Hand sorting				0.00	23.65
Shredder	6	25	56.81	1.30	1.81
	10	50	108.45	2.48	3.62
	15	50	129.11	2.96	3.62
	25	55	154.93	3.55	3.98
Trommel screen	15	20	103.29	2.36	1.45
	25	30	154.93	3.55	2.17

Note: Amortization cost was evaluated according to 10-year lifetime, operating 6 days/week, two 7-hour shifts/day. Electricity cost was estimated at 0.0723 Euro/kWh. Two operators per shift were assumed for hand sorting (Caputo and Pelagagge, 2002).

4.1.2. Pre-processing technologies and practices for sewage sludge

As shown in Figure 22, sewage sludge undergoes a mechanical dewatering process prior to pre-processing (ALF-CEMIND 2012). As the result of dewatering process, the dry solids content increases from 2 - 5 percent to 20 - 40 percent, depending on the characteristics of the raw sludge and the dewatering method applied. Appendix 5 shows a more complete flow diagram of sewage sludge pre- and co-processing from a project in Australia (EIPPCB 2006).

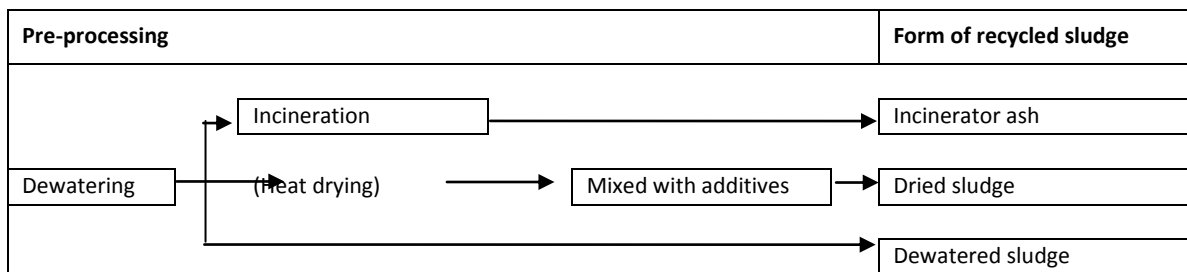

Figure 22. Schematic of sewage sludge pre-processing (Taruya et al. 2002)

Sewage sludge dewatering

Sludge dewatering increases the dry solids content of sludge, producing a sludge cake of 20 to 50 percent dry solids and an aqueous waste stream. The less additional processing required to remove contaminants from aqueous waste stream, the lower the cost of dewatering will be. To achieve more

than 10 percent dry solids content from dewatering, it is necessary to use chemical conditioning, such as high-molecular-weight polymeric flocculants, to assist in separating the bound and entrained water from the sludge (EIPPCB 2006).

There are different types of dewatering processes. The type of process used depends on the nature and frequency of the solids produced and the sludge cake required. For example, filter (or plate) presses use batch processing and can be labor intensive. A filter press can produce a sludge cake with up to 40-percent dry solids. The other type of dewatering technique uses a belt press, which is a continuous process with a filter cloth running through rollers that forcefully dewater the sludge. A belt press can produce sludge cake of up to 35-percent dry solids. Centrifuges also is a continuous process and can produce a cake of up to 40-percent dry solids. Filter presses are most commonly used for sludge from wastewater treatment plants (EIPPCB 2006). The energy required to raise the dry solids content of sludge from 5 to 35 percent by mechanical dewatering is approximately 3-5 kWh. To achieve these levels of dry residual content, organic coagulating or other precipitating agents are usually added (Reimann, 1999). In China, the cost of sludge dewatering (with an increase in dry solids content from 3 to 20 percent) is reported as 8-12 Renminbi per m³ of thickened sludge (IWA Water Wiki 2011).

In practice, dewatered sludge often contains approximately 70 to 80 percent water. This high water content can result in negative heat gain when the sludge is used in cement kilns. Using “fuel” with such a high water content can, in some cases, can cause the kiln temperature to drop below the minimum needed to create cement clinker, which will negatively affect product quality. Also, too much evaporated water increases the offgas flow rate, which could overload offgas cleaning devices and exceed fan capacity (Stasta et al. 2006). This will result into lower clinker production and eventually opportunity losses for selling cement in the local market. In addition, dewatered sludge is more costly to transport because of its large volume, and there is a risk of drainage and odors from sludge-conveying trucks. It is important to mitigate these risks when using dewatered sludge in kilns (Taruya et al. 2002).

Taruya et al. (2002) report that, of the total sewage sludge used in the cement industry in Japan in 2001 (approximately 1 million tons on a dewatered sludge basis), dewatered sludge represented more than half. However, they do not mention the average dry solid content of dewatered sludge in Japan. Also, in most places around the world, dewatered sludge is further processed by drying to increase its dry solids content before it is used in a cement co-processing plant.

Sewage sludge drying

As mentioned above, co-processing and incineration of dewatered sewage sludge are technically possible but may not be economical, so dewatered sludge is often dried to reduce its water content and increase its heat content (Onaka 2000). Sun or open air-drying are the method used to reduce moisture in dewatered sludge, which is effective if the sludge layer is thin and huge areas of land are available.

Other more effective and efficient drying techniques use the following types of dryers (Flaga, no date):

1. Convective dryers, in which sludge comes into direct contact with the drying medium (e.g., hot air). Convective (direct) dryers that can be used for sludge drying are pneumatic dryers (flash dryers), rotary or drum dryers, and fluidized bed dryers.

2. Contact dryers in which sludge comes into contact only with a surface that is heated from the other side by a heating medium. Contact (indirect) dryers that can be used for sludge are paddle dryers, hollow flight dryers, disc dryers, and multi-shelf dryers.
3. Mixed convective-contact dryers.
4. Infrared dryers that use infrared radiation or high-frequency current.

Some technologies can only partially dry sludge (to less than 85 or 90 percent dry solids), and it is not always necessary to dry sludge up to 90-percent or more dry solids (Flaga, no date). Hall (1999) gives a cost range of approximately US\$330-880/tonne of dry solids for sewage sludge drying. The subsections below explain several approaches for drying sewage sludge using different heat sources.

Drum dryer

In tube drum drying, dewatered sludge is transported on a chain conveyor and added to the revolving tube drum in single portions. The residence time of the dewatered sludge in the dryer and thus the dryness of the granulated sludge can be regulated by hydraulic adjustment of the tube angle. The energy used in the drying process is drawn from the waste heat of the associated cement process or incinerator.

Up to 30,000 m³/h drying air (maximum 100 °C) flows through the revolving tube in a direction counter to the dewatered sludge. The heat is used to evaporate water from the sludge, and the plume is extracted by suction through a dust filter and directly transferred to a bio-filter. The granulated dry sludge is discharged automatically by the drum's rotation and loaded into large bags or other containers (EIPPCB 2006).

It is important to avoid carbonization of sludge during drying because Hg emissions are at their highest level at carbonization temperature (160 °C). However, it also should be noted that even when drying is done at higher temperatures of the heating media, the granules itself remain on a temperature lower than 120 °C and are not emitting Hg. Due to this physical behaviour, sewage sludge dryers are not emitting Hg. As a consequence, permits for emission control of sewage sludge dryers often do not include Hg as a value to measure. Later, when the sludge is co-processed at the cement kiln, high levels of CaO are present, which prevents rapid Hg evaporation (Zabaniotou and Theofilou 2008).

Sewage sludge drying using waste heat from cement plant flue gas

Another approach to sewage sludge drying is to use waste heat from cement plant flue gas. Stasta et al. (2006) conducted a feasibility and economic analysis of sludge drying by utilizing excess cement plant heat and found that some of the main factors affecting the economics of such a project are: profit from sludge disposal, transport costs, amount of treated dry matter, and dry matter content in sludge (Stasta et al. 2006). They calculated that approximately 10.8 GJ of heat are necessary to dry 1 tonne of wet sludge. The report also shows that, when a counter-current shaft exchanger is used, cement plant flue gas can provide this amount of waste heat for sludge drying. Stasta et al. considered the rotating disc dryer technology for sludge drying, which entailed an investment cost of approximately US\$ 2.64 million for the whole project. This resulted in a payback period of approximately 5 years (Stasta et al. 2006). Another case study in Australia assessed the use of a horizontal fluidized bed dryer for sludge drying. The

estimated capital cost for this type of dryer was around US\$ 2.4-3.4 million for 60,000 t/year of dry sludge (APP 2011). Other case-studies for successful utilization of cement plant's waste heat for sewage sludge drying are reported in Germany, Turkey, and China. Figure 23 diagrams the use of cement plant flue gas heat for sludge drying.

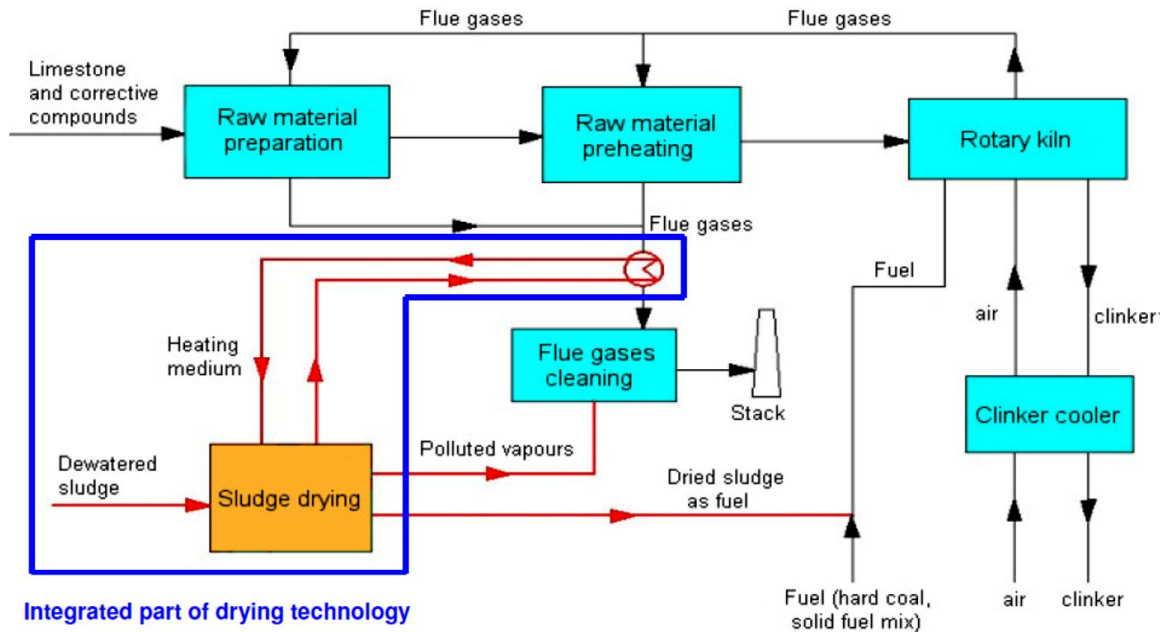

Figure 23. Using cement plant's flue gas heat for sludge drying (Stehlík et al., no date)

Use of biogas from anaerobic sludge digestion for heat drying

Anaerobic digestion is a series of processes in which microorganisms break down biodegradable material in the absence of O_2 . Anaerobic digestion is used to manage waste and/or to release energy for industrial or domestic purposes. The main features of the anaerobic digestion process used for treating sludge are mass reduction, biogas production, and improved dewatering properties of the treated sludge. Figure 24 shows sludge processing with anaerobic digestion (Hanjie 2010). The biogas produced by sludge anaerobic digestion can be used for heat drying the dewatered sludge if waste heat from the cement plant is not available. This will avoid the use of conventional fuels for heat drying. The amount of gas produced by anaerobic sludge digestion is reported equal to 362 - 612 liters per kg volatile solids for primary sludge⁷ and 275-380 liters per kg volatile solids for activated sludge⁸ (Hanjie 2010).

⁷ Primary sludge is also called raw sludge and comes from the bottom of the primary clarifier. Primary sludge is easily biodegradable.

⁸ Activated sludge is also called excess sludge or waste activated sludge and comes from the secondary treatment. Activated sludge is more difficult to digest than primary sludge.

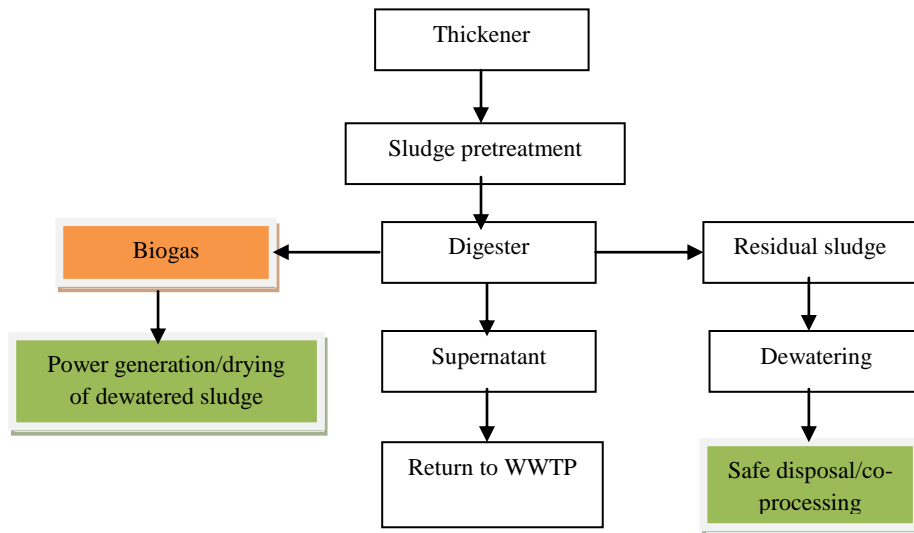

WWTP = wastewater treatment plant

Figure 24. Sludge processing steps including anaerobic digestion (Hanjie 2010)

Table 14 shows the CO₂ emissions per tonne of dry sludge produced by different methods and used in HeidelbergCement plants in Turkey and China. The three sludge drying methods are: 100-percent use of natural gas, 50-percent replacement of natural gas by sludge digestion gas, and 100-percent waste heat from cement process used for sludge drying (Theulen 2011). Table 14 shows that, from a CO₂ emissions reduction perspective, co-processing of sewage sludge is preferable to sludge incineration and the greatest CO₂ emissions reduction is achieved when sludge is dried using only waste heat from the cement kiln.

Table 14. CO₂ emissions per tonne of the dry sludge produced by different methods and used in a cement plant or incinerator (Theulen 2011)

Sludge drying method	Heat source	CO ₂ emissions (in CO ₂ equivalent) per tonne of dry sludge	
		Cement Co-processing	Incineration
100% natural gas	Natural gas network	-400 kg	+600 kg
50% natural gas, 50% sludge digestion gas	Sludge digestion	-750 kg	
100% waste heat	Cement kiln	-1,100 kg	

Drying by blending the dewatered sludge with quicklime

Another sludge drying technique used in Nara Prefecture, Japan is blending dewatered sludge with quicklime, resulting in a usable raw material for cement production. This process dries the sludge using heat generated by the following hydration reaction:

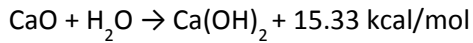

The resulting product, called dried powder sludge, has a very low moisture content, is odorless, and can be used as alternative fuel and raw material in the cement industry. Figure 25 shows this drying process. Waste gas generated from the digesting and blending machine contains as much as 2,400 mg/l dust and ammonia. The waste gas is treated with a bag filter, chemical scrubbing, and activated carbon absorption processes. Using this process, dewatered sludge with 80 percent moisture content can be converted to dried sludge with 5 percent moisture. The dried sludge includes particles of approximately 100 to 200 micrometers (μm) average diameter and can be stored for more than 10 days (Taruya et al. 2002).

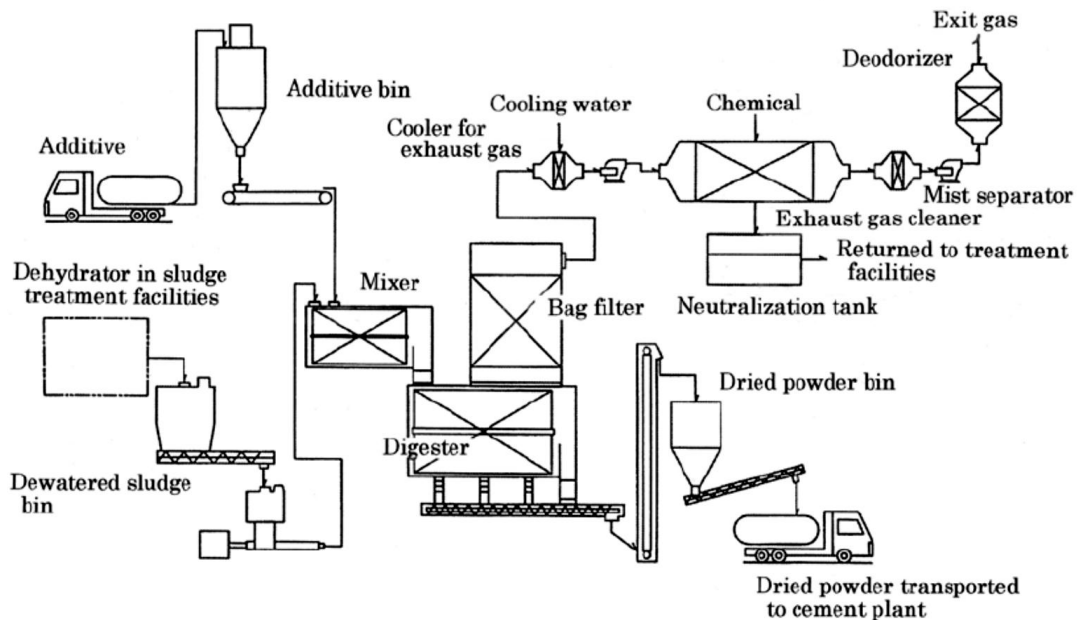

Figure 25. Powder sludge manufacturing in Nara Prefecture, Japan (Taruya et al. 2002)

Solar Drying of Sewage Sludge

In this type of dryer, the solar radiation warms the sludge's surface. The rise in the temperature forces the water molecules out into the surrounding air. The moist air transports the water and has to be evacuated. However, while the surface dries, the lower parts remain moist, and have to be dried or turned. Some systems are designed to turn over the sludge so its other side can get the sun light by a turning and conveying machine. In some other systems, the sludge is dried in a greenhouse using the solar generated heat and the bottom of the sludge is dried by a floor heating system that can be heated with waste heat from different other processes. Anlagenbau GmbH is one of the technology providers for the solar sludge drying. More than 100 systems exist worldwide and are applied mainly in rural areas, serving small communities.

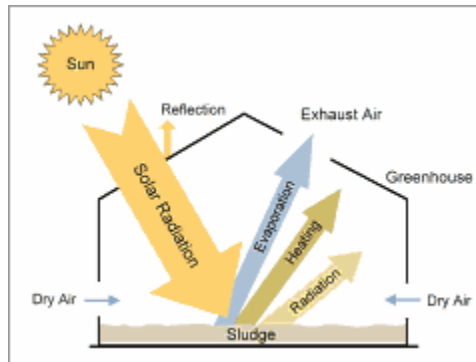

Figure 26. Schematic of open air drying beds solar sludge dryers with natural ventilation (Anlagenbau GmbH 2012)

Dried sewage sludge grinding

In particular cases it might be worthwhile to grind the dry sewage sludge before adding it to the main burner of a cement kiln. This is particularly done when the amount of alternative coarse fuels in the main burner is very high and the fineness of the sewage sludge is a key parameter to keep the flame with enough intensity. Since this was the case in the Maastricht kiln in the Netherlands, the plant decided to grind the sewage sludge until 15 to 25 percent of the sludge is 90 microns in order to have good flame performance (Takx 2002). Different grinding system can be used for this purpose.

In February 2000, ENCI Cement Plant in the Netherlands, in cooperation with Claudius Peters, installed a vertical roller mill, called a “BioMill,” for milling dried sewage sludge. The mill is supplied with ambient air and consists of five large grinding balls revolving around a grinding table that is less than 2 m in diameter. The mill’s energy consumption is approximately 40 kWh/t (ALF-CEMIND 2012). The grinding system has a static precipitator with manual control of the fineness of the final product. The ground sludge is stored in silos equipped with pressure-relief valves and dust filters. The bag filter has three explosion valves. The ground sludge is transported to a small (100 m³) silo on the burner floor. This silo has a pressure-relief valve and a filter. The sludge is then fed to the kiln by a dosing system (Takx 2002) (Figure 27). In another case study in Australia, a vertical roller mill was used for grinding dried sludge before co-processing in the kiln. The estimated capital cost was approximately US\$ 3.3-4.8 million for 60,000 t/year of dry sludge (APP 2011).

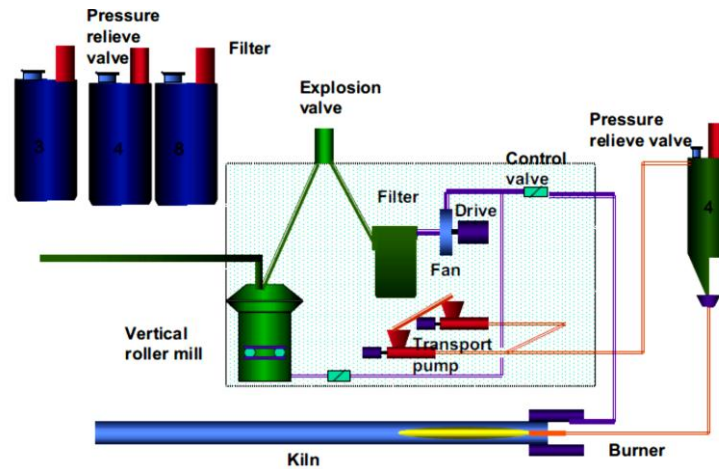

Figure 27. Dried sewage sludge grinding system (BioMill) (Takx 2002)

Cost of sewage sludge pre-processing

Treatment units used in the sewage sludge pre-processing process include mechanical screens, gravity thickeners, mechanical thickeners, decanter centrifuges, anaerobic digesters, and sludge dryers. In practice, combinations of these units might be used (Gorgun and Insel 2007). Gorgun and Insel (2007) evaluated several different process alternatives in Turkey that are made up of combinations of sludge treatment units. Table 15 shows the investment costs, annual operational costs, and payback periods for these alternatives. Steiner et al. (2002) also discuss the economic aspects of sludge management and give the cost of sewage sludge treatment plants in different developing countries.

Table 15. Investment and annual operational cost, and payback periods of several process alternatives for sludge pre-processing (Gorgun and Insel 2007)

Alternative	Description	Investment Cost (US\$)	Annual Operational Cost (US\$)	Payback Period
Mechanical screen (MS)	MS removes total suspended solids in influent wastewater.	170,000	17,000	5 months
MS+Mechanical thickener (MT)	In addition to MS, primary and secondary sludge are combined and subjected to MT (belt press). Approx. 20% solids content can be achieved with the addition of polymer.	290,000	29,000	8 months
MS+MT+Decanter centrifuge (DC)	Primary and secondary sludge are combined and subjected to MT, then introduced to DC. Up to 30% of solids content can be achieved with the addition of polymer.	600,000	60,000	15 months
MS+MT+DC+Sludge Drier (SD)	In comparison to the previous option, solids content can be increased up to 90%.	5,400,000	195,000	9 years
MS+MT+Anaerobic digester (AD)	ADs require 4-6% solid content for optimal operation. An AD can produce biogas to be used for power generation or sludge drying. Ads reduce the organic content of the sludge.	2,690,000	36,000*	5.5 years
MS+MT+AD+DC	In addition to anaerobic digestion, the solids content can be increased up to 90% by DC.	3,000,000	66,000*	5.7 years

* Energy recovery from AD is included

4.2. Storage, handling, and feeding systems

In most cases, special trucks transport pre-processed fuel to a storage site at the co-processing cement plant. The waste material should be properly stored at the plant site in accordance with laws and regulations. Vapor filtration and capture equipment should be in place to minimize the impact of unloading activities on the reception point and surrounding areas (WBCSD 2005). From the storage area, automatic conveyors move the waste to the feed point in the cement kiln system. A dosing system precisely controls the appropriate feed rate of the fuel into the kiln (ALF-CEMIND 2012) (Figure 28). Based on a feasibility study of using sewage sludge in a cement plant in Australia, APP (2011) says the power requirement is approximately 235 kW for receiving, storage, conveying, and feeding of dried sewage sludge in the cement plant. The estimated capital cost for the system was around US\$ 6-11.5 million for 60,000 t/year of dry sludge (APP 2011).

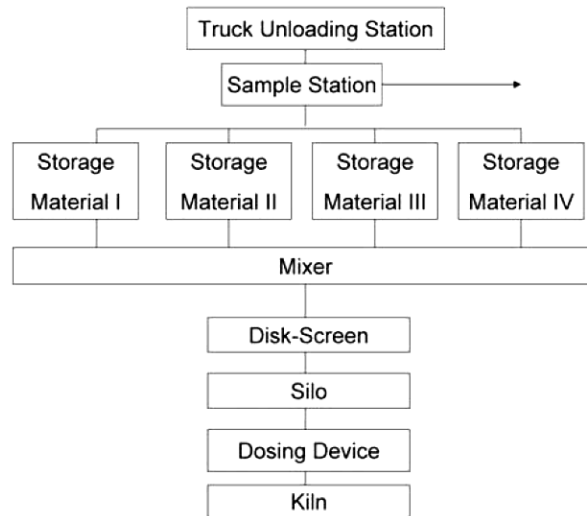

Figure 28. Handling of waste fuel at a cement plant (Reinhard 2008)

4.2.1. Storage

Different storage systems can be used for alternative fuels, including storage halls with reclaiming facilities or storage silos with discharge systems. The type of storage used might depend on the type of waste material. Storage for RDF would be in industrial hangars to preserve the RDF's moisture content and other properties and minimize visual and odor impacts as well as spillage.

Sewage sludge is very abrasive, and, depending on its solid matter content, is prone to fermentation during usage (ALF-CEMIND 2012). The brewing or self-heating quality of sludge can also cause fire or explosions in the storage and grinding system (Takx 2002). Special attention should be paid to these properties when designing handling and storage installations at the cement plant. Closed cylindrical silos with special mechanical discharge devices (cone dischargers or flat-bottomed discharge systems) are used for sewage sludge storage to minimize health impacts. Normally, storage silos are equipped with special cone dischargers (ALF-CEMIND 2012).

4.2.2. Handling and conveyors

Depending on the system configuration and waste type, pneumatic or mechanical transport system moves the waste fuels within the cement plant and feeds them into the cement kiln. A mechanical transport system is less energy intensive. For mechanical transport, different systems can be used (ALF-CEMIND 2012) (Figure 29). Solid materials handling systems need to have adequate dust control systems.



Figure 29. Mechanical transport systems (Hock 2008)

4.2.3. Feeding and dosing systems

Depending on the waste fuel feed point, different feeding systems can be used. Any type of feeding system used should ensure high accuracy and consistence, avoid down times caused by blockages, and be able to flexibly accommodate a range of fuels. Figures 30 and Figure 31 show an example of a handling and dosing system used for feeding RDF into a calciner and into a kiln, respectively.

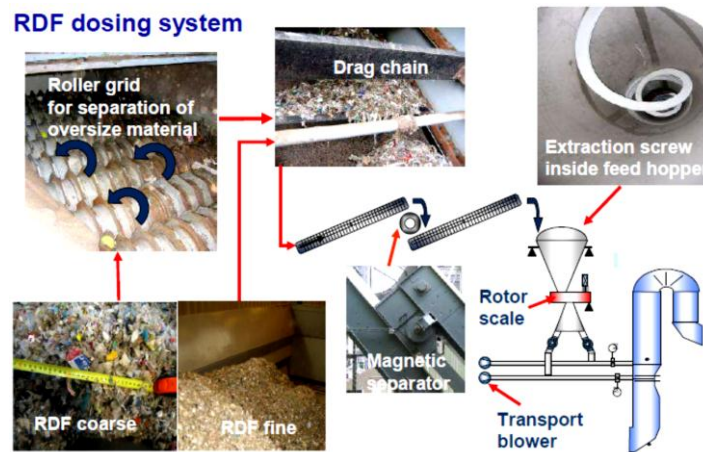

Figure 30. Example of an RDF handling and dosing system for feeding RDF into a calciner (Hempel 2011)

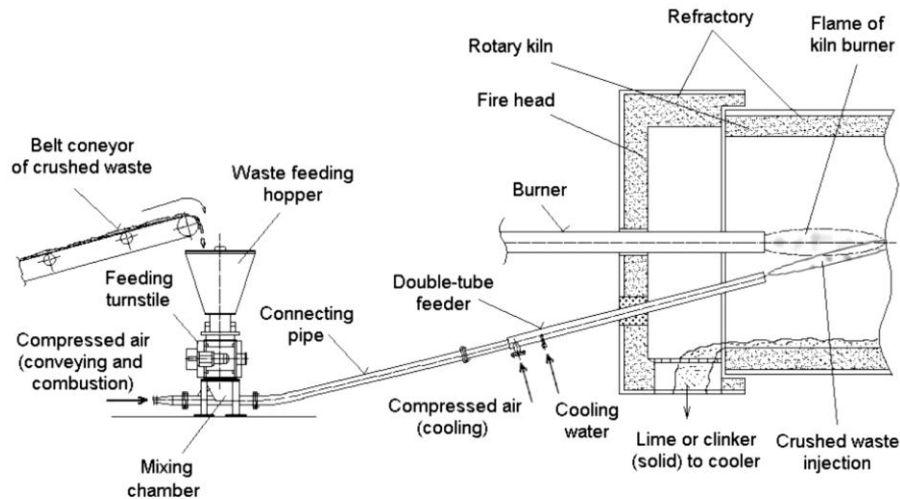

Figure 31. Example of RDF handling and dosing system for feeding RDF into a kiln’s main burner (Stehlík et al., no date)

Dosing systems feed fuel to the kiln system at a predefined ratio. Depending on the waste, different types of dosing systems are used. For instance, Schenck Process offers a rotor weighfeeder, and FLSmidth PFISTER offers screw weighfeeder (Figure 32). Another example is the mid-kiln fuel injector provided by Cadence (Figure 33). Waste-derived fuels are placed on the apparatus, which rotates with the kiln. As the fuel injector reaches the vertical position, a mechanism allows the fuel to drop into the center of the kiln. This system can be quickly fitted to the cement kiln. Its payback time is 1 year or shorter (Cadence 2012a).

A storage and feeding system for co-processing of sewage sludge for 45,000 t/year was installed in a cement plant in Turkey by HeidelbergCement for an investment of \$2.8 million.⁹



Figure 32. Rotor weighfeeders (left) and screw weighfeeders (right) for dosing solid waste fuels (Leong 2008; Schenck Process 2009)

⁹ Cement Sustainability Initiative (CSI), personal communication. June 2012.



Figure 33. Cadence’s mid-kiln fuel injector technology (Cadence 2012a)

4.3. Co-processing of MSW and Sewage Sludge in the Cement Kiln

Typically, RDF may replace 15-20 percent of primary fossil fuels used in cement plants around the world (ALF-CEMIND 2012) although this proportion can be as high as 30 percent (Murray and Price 2008) and in case of high quality RDF it can be up to 60%¹⁰. The maximal sewage sludge feed rate should not be more than 5 percent of clinker production capacity. Consequently, for a 2,000 t/day cement kiln, a maximum of 100 ton per day dry sludge could be used without degrading the clinker quality (ALF-CEMIND 2012). The European Commission (2004) indicates that sewage sludge can replace up to 20 percent of primary fossil fuels used in cement plants.

Replacing coal or pet coke with RDF results in a more than 15-percent increase in the waste gas produced. In a system with a constant blower capacity and a limit on the quantity of fumes that can be emitted, use of RDF can be accommodated in two ways: 1) thermal conditions, i.e., the temperature profile, can be maintained by providing a smaller amount of secondary air (the percentage of O₂ in the dry fumes will be smaller), or 2) the dilution factor can be maintained, resulting in the same O₂ concentration in the waste gas and a lower combustion temperature. Either of these choices can result in a reduced rate of NO_x formation (Genon and Brizio 2008).

4.3.1. Selection of feed point for alternative fuels

Given the differences in temperature in different parts of the cement production process, it is important that waste materials be introduced at the correct point (feed point) in the process to ensure complete combustion or incorporation and to avoid unwanted emissions. The feed point should be selected according to the nature of the waste fuels (WBCSD 2005). The most common points at which wastes are inserted into the cement production process are (Stockholm Convention 2006):

- the main burner at the rotary kiln outlet end
- the feed chute at the transition chamber at the rotary kiln inlet end (for lump fuel)
- the secondary burners to the riser duct
- the precalciner burners to the precalciner

¹⁰Cement Sustainability Initiative (CSI), personal communication. June 2012.

- the feed chute to the precalciner (for lump fuel)
- the mid kiln valve in the case of long wet and dry kilns (for lump fuel)

The appropriate points for feeding waste fuel to the kiln system in relation to temperature and residence time depend on the kiln design, type, and operation (Figure 34). Overall, the kiln should operate in a way that ensures that the gas resulting from the co-processing of waste is raised, in a controlled and homogeneous fashion even under the most unfavorable conditions, to a temperature of 850°C for 2 seconds. If waste with a content of more than 1 percent of halogenated organic substances (chlorine) is co-processed, this temperature needs to be raised to 1,100°C -1,200°C for at least 2 seconds (EIPPCB 2010).

Waste fuels with highly stable molecules, such as highly chlorinated compounds, should be introduced at the main burner where the high combustion temperature and long retention time will ensure complete combustion. Waste with VOCs may be introduced at the main burner, in mid-kiln, in the riser duct, or at the precalciner but should not be introduced with other raw materials except where tests demonstrate that this will have no effect on the offgas (WBCSD 2005). Hazardous waste should be fed through either the main burner or the secondary burner of preheater/precalciner kilns. Hazardous and other wastes fed through the main burner will be decomposed under oxidizing conditions at a flame temperature of more than 1,800°C. Waste fed to a secondary burner, preheater, or precalciner will be decomposed at an expected burning zone temperature of typically more than 1,000°C (Basel Convention 2011). Wastes should be fed into the kiln system continuously except during operations such as startups and shutdowns when appropriate temperatures and residence times cannot be achieved (EIPPCB 2010).

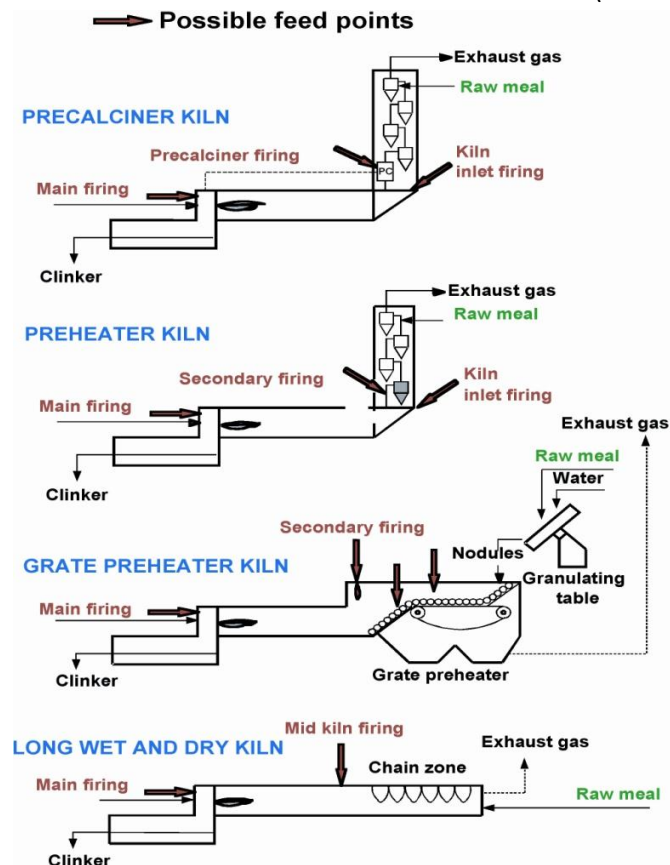

Figure 34. Typical waste feed points (Basel Convention 2011)¹¹

4.3.2. Multi-fuel burners

One of the most important modifications that a cement plant must make for waste co-processing is to install a burner that can handle both traditional primary fossil fuels and waste-derived fuels. The most popular burner type today is the so called multi-fuel burner, which is offered almost by all equipment suppliers (ALF-CEMIND 2012). KHD's PYRO-Jet burner (Figure 35) is an example; this burner is used in Switzerland for multiple fuels in the following proportions (Hand 2007):

- 25 percent coal
- 19 percent oil
- 13 percent solvents
- 34 percent plastics (<10 mm)
- 9 percent sewage sludge

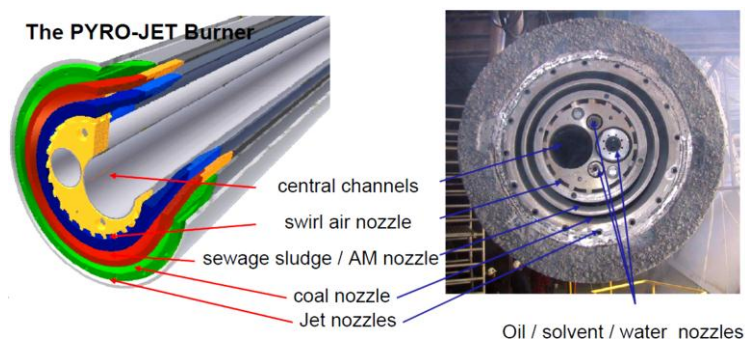

Figure 35. Cross-section view of a multi-fuel burner (Hand 2007)

Multi-fuel burners consist of concentric tubes. Air gaps between the concentric tubes enable injection of compressed combustion air. Steam is used to assist in injecting certain fuels. Inside or adjacent to the concentric tubes, tubes are installed with special nozzles for injection of secondary air and/or liquid fossil and alternative fuels. The inner tube is the channel for the solid waste fuels because it offers the most abundant cross section of all the concentric tubes (ALF-CEMIND 2012).

Some commercial multi-fuel burners are:

- SUSPENSION burner by Cadence Environmental Energy Inc.¹²
- FCT MULTI-FUEL kiln burner by FCT-Combustion¹³
- DUOFLEX burner by FLSmidth¹⁴

¹¹ See Appendix 2 for a diagram of reaction zones for different kiln technologies.

¹² <http://www.cadencerecycling.com/>

¹³ <http://www.fctinternational.com/>

¹⁴ <http://www.flsmidth.com/>

- LOW-NOx FLEXIFLAME™ burner by Greco-Enfil International S.L.¹⁵
- PYRO-JET® burner and PYROSTREAM® burner by KHD Humboldt Wedag GmbH¹⁶
- ROTAFLAM® rotary kiln burner and calcination burner by PILLARD FEUERUNGEN GmbH¹⁷
- Clinkering zone burner by Polysius AG¹⁸
- M.A.S. burner and UNICAL calciner burner by Unitherm Cemcon Firingsystems GesmbH¹⁹

Appendix 9 contains a short list of technology providers for pre- and co-processing of alternative fuels in the cement industry.

4.3.3. Additional kiln system improvements/retrofits for co-processing

Solid alternative fuel combustion behavior differs from that of coal in several ways (Jensen 2008):

- The pyrolysis rate has a greater influence on alternative fuel burnout.
- Diffusion of oxygen limits alternative fuel combustion rate to a greater extent than it limits the combustion rate of coal.
- Temperature does not have a strong effect on burnout of alternative fuel.
- Particle size is not simply related to the sieve residue of alternative fuel.

Figure 36 shows the relationship between particle size and burnout time of different types of solid fuel. Solid alternative fuels usually have a higher burnout time because of their larger particle size compared to that of coal. This can cause operational problems in a normal cement plant unless the plant design accounts for this phenomenon (Jensen 2008).

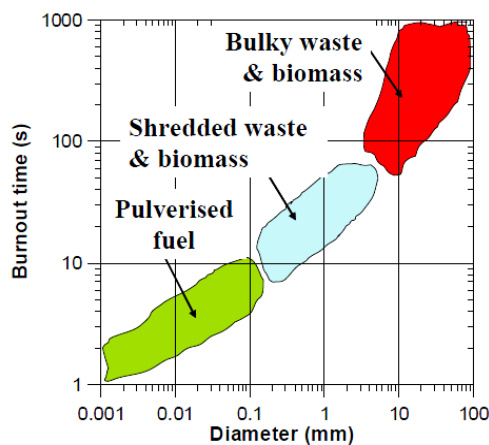

Figure 36. Relation of particle size and burnout time for different types of fuel used in cement kilns (Jensen 2008)

¹⁵ <http://www.grecoenfil.com/>

¹⁶ <http://www.humboldt-wedag.de/>

¹⁷ <http://www.pillard.de/>

¹⁸ <http://www.polysius.com/>

¹⁹ <http://www.unitherm.co.at/>

Calciner configurations and retrofits

Different calciner configurations facilitate use of various alternative fuels with different properties and address the abovementioned issue of burnout time (Figure 37). For shredded waste and biomass, the extended calciner residence time provides enough time for fuel burnout whereas for bulky biomass and waste streams, design changes are required (Figure 36), such as installation of additional equipment (for example, KHD Humboldt Wedag’s combustion chamber or FLSmidth’s HOTDISC).

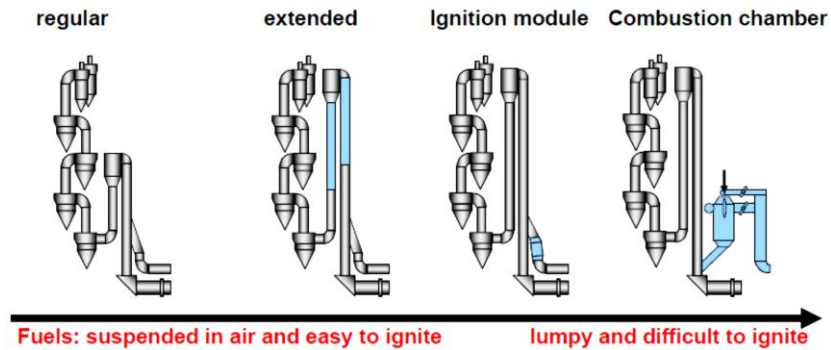

Figure 37. Different calciner configurations for co-processing alternative fuels (Hand 2007)

KHD Humboldt Wedag’s combustion chamber is a new addition to kiln system components. It allows increased use of low-quality alternative fuels in co-processing (Figure 38). The combustion chamber has been in operation at a cement plant in Norway since 2004. Since the retrofit, 60 percent of the total fuel used in the kiln system is fed through the combustion chamber. The fuel composition is 6-percent coal/petcoke/animal meal mix, 16-percent solid hazardous waste, and 38-percent fluff RDF (Hand 2007).

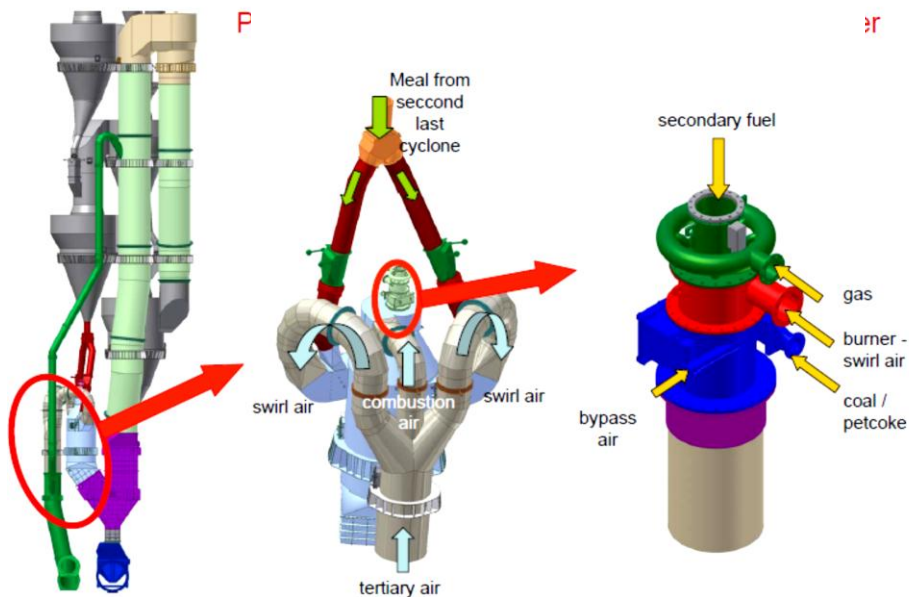

Figure 38. Precalciner with KHD Humboldt Wedag’s combustion chamber (Hand 2007)

Another major cement technology supplier, FLSmidth, provides calciner solutions, including the HOTDISC, for co-processing alternative fuels (Jensen 2008). The HOTDISC is added to the calciner and functions as a moving hearth furnace. When alternative fuel, preheated raw meal, and tertiary air are fed into the HOTDISC, it produces combustion gases, partly calcined meal, and combustion residues. These are then processed in the calciner along with the other streams (Figure 39). The result is calcined meal ready for the kiln, with well-controlled emissions. The heat content of the alternative fuels is used for calcination. The extra residence time for the fuel minimizes volatile circulation and blockages at the kiln inlet (FLSmidth 2011).

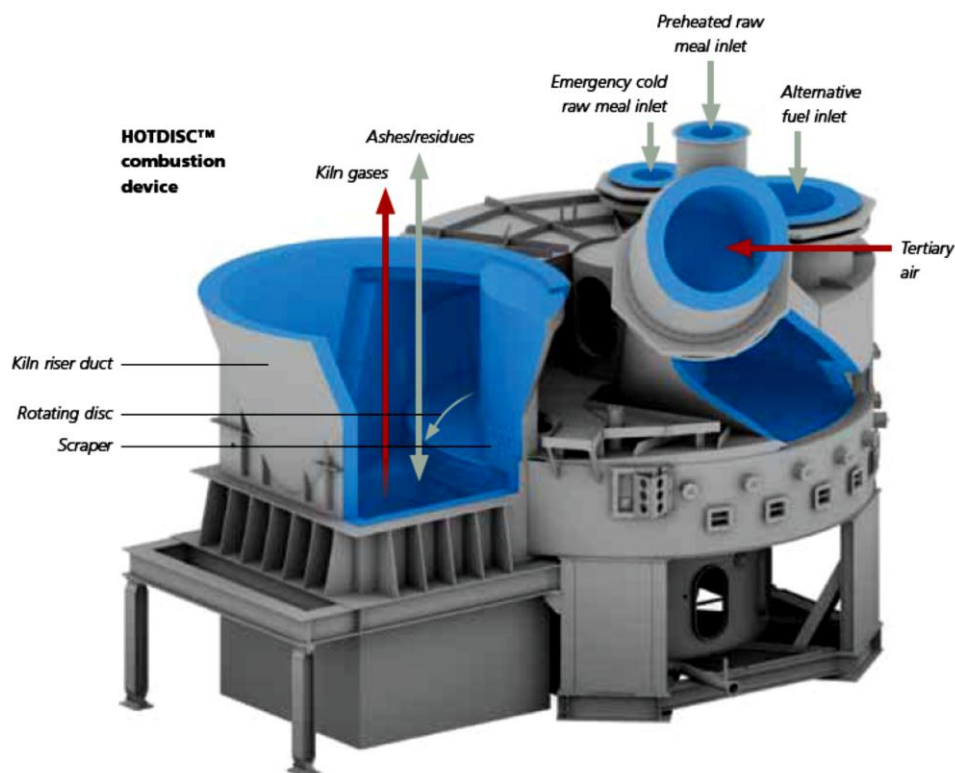

Figure 39. FLSmidth’s HOTDISC (FLSmidth 2011)

Mixing air technology for the kiln

Higher-temperature O₂-rich gases tend to travel along the top of the kiln, and cooler, CO₂-rich gases tend to travel along the bottom. This gas stratification inhibits the combustion process, limits alternative fuel usage, and contributes to emissions. Adding high-velocity opposing streams of mixing air causes the stratified kiln gas layers to rotate and mix (Figure 40). This rotation improves combustion and allows for increased alternative fuel use, significant NO_x reduction, lower emissions, less sulfur buildup, improved thermal efficiency, and overall better product quality (ALF-CEMIND 2012).

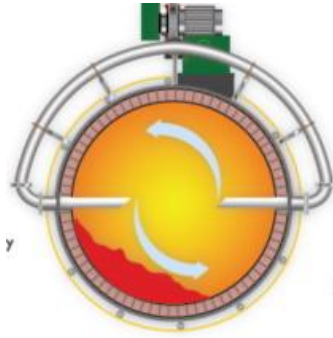

Figure 40. Mixing air technology (ALF-CEMIND 2012)

Pneumo-swirl-device for solid waste fuel co-firing

Solid waste fuels are conveyed by compressed air through a piping system to the burner. The waste fuel channel inside the burner is basically a pipe of the same diameter as the fuel conveyor pipe. The Pneumo-swirl-device can be installed at the hot end of this pipe and sets the fuel flow into a defined rotation. The air necessary to create this rotation is taken from the burner’s primary air pipe system, so compressed air is not necessary. The Pneumo-swirl-device has slots around the circumference of the waste fuel pipe (ALF-CEMIND 2012). A low swirl intensity results in a large throwing length, and a high swirl intensity increases the throwing angle so that alternative fuel is deflected into the flame, and the time for burnout is extended as well (Figure 41).

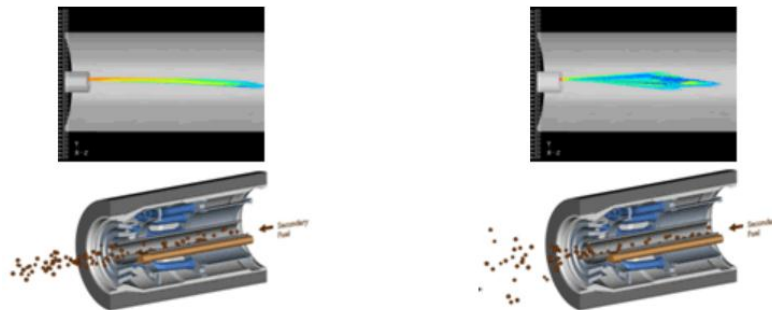

Figure 41. Low swirl intensity (left) and high swirl intensity (right) provided by the Pneumo-swirl-device (Unitherm Cemcon 2012)

4.4. Product Quality Control Systems

Depending on the amounts of alternative raw materials and fuels used in co-processing, the concentration of individual elements in the final product can increase or decrease compared to the results with traditional fossil fuels. As cement is blended with aggregate, e.g., gravel and sand for the production of concrete or mortar, the behavior of these trace elements in the building material (concrete or mortar) is a critical determinant of environmental impacts of the co-processed product as well as impacts on the product quality (CEMBUREAU 2009).

Heavy metal releases from concrete and mortar are minimal because these metals remain firmly trapped in the product. Independent tests on concrete and mortar have shown that the leaching of heavy metal concentrations is significantly below limits prescribed by national legislations. In addition, as noted earlier, according to the European Cement Industry Association, environmental releases have not been detected when products containing heavy metals are stored under extreme conditions (CEMBUREAU 2009).

Phosphate content influences cement setting time. Chlorine (which should be less than 0.1 percent in cement), sulphur, and alkali content all affect overall product quality. Thus, the amount of these elements in clinker and cement should be monitored closely at plants where waste is co-processed. Thallium and chromium content should also be monitored in cement kiln dust and final products because of possible allergic reactions in sensitive users (Stockholm Convention 2006).

4.5. Emissions and Air Pollution

Cement kiln emissions result from physical and chemical reactions of raw materials and from combustion of fuels. The main constituents of kiln exit gases are nitrogen from the combustion air, CO₂ from calcination and combustion, water from the combustion process and raw materials, and excess O₂. The exit gases also contain small quantities of dust, chlorides, fluorides, SO₂, NO_x, CO, and even smaller quantities of organic compounds and heavy metals (Stantec 2011).

4.5.1. Impact of co-processing on kiln emissions

The impact of waste co-processing on emissions from cement manufacturing is relatively minor if co-processing is done correctly and in compliance with strict regulations. Nonetheless, it is important to compare the presence of nitrogen, sulphur, chlorine, and other elements in the waste fuel with the concentrations of these elements in fossil fuels. The subsections below discuss some of these important elements in more detail.

Sulphur

Because clinker has an alkaline matrix, the presence of sulphur in waste fuels does not result in critical levels of sulphur gas emissions. However, the possibility that sulphur might react with different metals in raw meal must be considered. The concentration of sulphur in substitute fuels is generally much lower than the reference value in conventional fossil fuels (0.1-0.2 percent in RDF, 3-5 percent in fossil fuels). Therefore, there is no problem of precipitation or clogging from sulphur in alternative fuels. However, issues of alkali sequestration and transfer in the clinker must be assessed (Genon and Brizio 2008).

NO_x

Nitrogen is responsible for the formation of NO_x. In general, formation of NO_x is related to the amount of nitrogen in the fuel, the temperatures in the kiln, the residence times, and the types of burners (Genon and Brizio 2008). RDF has low nitrogen content (0.3-0.5 percent) in comparison with fossil fuels (1.5-2 percent). Overall, alternative fuels do not lead to higher NO_x emissions and, in some cases, NO_x

emissions can even be lower when waste fuels are used (Genon and Brizio 2008). A rotary kiln in which raw materials are sintered at a temperature of 1,450°C using fossil fuel emits a large volume of NOx gas. When dewatered sludge is injected into the kiln, ammonia contained in the dewatered sludge decomposes NOx as follows:

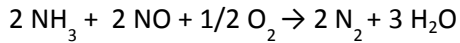

where:

NH₃ = ammonia

NO = nitrogen oxide

N₂ = nitrogen dioxide

H₂O = water

Figure 42 shows an example of NOx emissions from a cement kiln where dewatered sludge is injected. Using sludge eliminates 40 percent of the NOx emitted when only traditional fuel (e.g. coal) is burned. Also, the small amount of primary air used in third-generation burners results in a low flame temperature and hinders the thermal conversion of sludge nitrogen to NOx (Zabaniotou and Theofilou 2008). Nevertheless, the ratio of sludge in the fuel must be controlled carefully (Fytilli and Zabaniotou 2008).

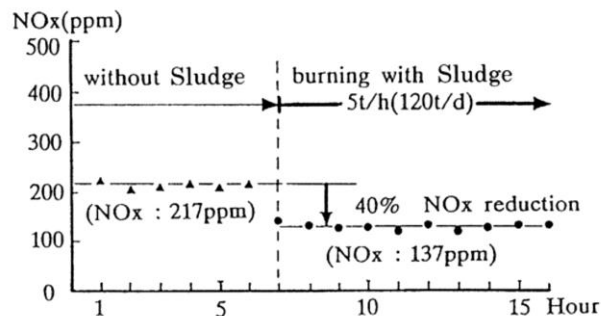

Figure 42. NOx Emissions of a cement kiln with and without co-processing of sewage sludge (Taruya et al. 2002)

Chlorine

The presence of chlorine in waste fuels can have both direct and indirect effects on cement kiln emissions and performance. Methods have been developed to manage chlorine and its potential effects, but it is important that these effects are recognized and managed. Trace levels of chlorine in feed materials can lead to the formation of acidic gases such as HCl and HF (WBCSD 2002). Chlorine compounds can also build up on kiln surfaces and lead to corrosion (McIlveen-Wright 2007). Introduction of chlorine into the kiln may also increase the volatility of heavy metals (Reijnders 2007) and foster the formation of dioxins.

Genon and Brizio (2008) indicate that the alkaline matrix of the clinker means that the presence of chlorine in substitute fuels does not result in critical levels of gaseous emissions. However, if the chlorine content of the fuel approaches 0.3-0.5 percent, this can lead to reactions between alkali and chlorine, the volatilization of chlorides and their recycling with dust, and the need to operate a bypass (extraction of part of the flue gas) to limit the chlorides in the final clinker. The high temperature of bypassed gases means increased heat consumption. Each percentage increase of bypassed gas requires approximately an additional 20-25 MJ/t of clinker, compared to a total energy consumption of 3,000-3,500 MJ/t in the cement kiln (Genon and Brizio 2008).

Heavy Metals

The use of suitable waste has only a minor influence on metal emissions because of the high retention of metals in the finished product. Non-volatile metals tend to be bound almost completely in the clinker matrix. Semi-volatile metals such as Pb or Cd tend to be captured in the clinker stream or in dust (EIPPCB 2010). A study using the U.S. EPA's toxicity characteristic leaching procedure to test the mobility of heavy metals in clinker when exposed to acidic conditions found that only Cd could be detected in the environment, and it was at levels below regulatory standards, which is 5 parts per million (ppm) (Shih 2005). Highly volatile metals such as Hg and Cd are of primary concern because they tend to vaporize and leave the kiln system (EIPPCB 2010). In traditional incineration processes, Hg (and other heavy metal) emissions are effectively controlled with the combination of a wet scrubber followed by carbon injection and a fabric filter. Similar control options are under development for cement kilns including using adsorptive materials for Hg capture (Peltier 2003; Reijnders 2007). At present, the use of dust removal devices like electrostatic precipitators and fabric filters is common practice, but these devices respectively capture only about 25 percent and 50 percent of potential Hg emissions (UNEP Chemicals 2005). The only way to effectively control the release of these volatile metals from cement kilns is to limit their concentrations in the raw materials and waste fuel (Mokrzycki et al. 2003; UNEP Chemicals 2005).

Normally, mercury in sludge comes from either the cleaning process at the sewage plant or from the incoming sewerage where it is present (Zabaniotou and Theofilou 2008). Giant Cement, in the United States, limits the Hg and Cd contents in alternative fuels for their kilns to less than 10 ppm and 440 ppm, respectively. These limits are significantly lower than those for other metals such as Pb, chromium, and zinc, which can be as high as 2,900, 7,500, and 90,000 ppm, respectively (Murray and Price 2008).

Dioxins and furans

The Stockholm Convention requires parties to reduce or eliminate releases of POPs that result from intentional production and use, from unintentional production, and from stockpiles and wastes (Stockholm Convention 2006). The formation of POPs such as PCDDs and PCDFs is a recognized concern for cement manufacturing. PCDDs and PCDFs have the potential to form if chlorine is present in the input fuel or raw materials. Formation can be repressed, however, by the high temperatures and long residence times that are standard in cement kilns (Karstensen 2008).

As noted earlier, the location at which waste materials are fed into the kiln system is an important factor. In this case, wastes that are fed into the main firing system tend to reach high enough temperatures and achieve long enough retention times to limit PCDD/PCDF emissions. Wastes fed into the secondary firing zone might not reach high enough temperatures or achieve long enough retention times (EIPPCB 2010). PCDD/PCDF formation is further minimized by limiting the concentration of organics in the raw material mix and by quickly cooling the exhaust gases in wet and long dry kilns. Evidence from several operating kilns suggests that preheater/precalciner kilns have slightly lower PCDD/PCDF emissions than wet kilns (WBCSD 2002; Karstensen 2008).

Numerous studies comparing PCDD/PCDF formation in kilns using conventional and waste-derived fuels have found no significant difference in the emissions from the two (Murray and Price 2008; EIPPCB 2010). Karstensen (2008) reviewed more than 2,000 PCDD/PCDF cement kiln measurements from various studies representing most production technologies and waste feeding scenarios. The data generally indicate that most modern cement kilns can meet an emissions level of 0.1 ng I-TEQ/m³ and that responsible use of organic hazardous and other wastes to replace a portion of fossil fuels is not an important factor influencing the formation of PCDD/PCDFs (Karstensen 2008).

Lafarge investigated the possible effect of feeding different wastes to the lower-temperature preheater/precalciner. Table 16 presents the results. Wastes injected at mid or feed-end locations do not experience the same elevated temperatures and long residence times as wastes introduced at the main burner. The observed concentration level of PCDD/PCDFs was low in all measurements. The reported data indicate that cement kilns can comply with an emissions level of 0.1 ng I-TEQ/Nm³, which is the limit in several western European countries' legislation governing hazardous waste incineration plants (Karstensen 2006).

Table 16. Influence of feeding wastes to the preheater/precalciner on PCDD/PCDF emissions (Karstensen 2006)

Plant	Type of alternative fuel	PCDD/F emissions in ng I-TEQ/Nm ³
1	Animal meal, plastics, and textiles	0.0025
2	Animal meal and impregnated sawdust	0.0033
3	Coal, plastic, and tires	0.0021 & 0.0041
4	Tires	0.002 & 0.0060
5	Petcoke, plastic, and waste oil	0.0010
6	Petcoke, sunflower shells, and waste oil	0.01200
7	Tire chips	0.004 & 0.02100
8	Solvents	0.0700
9	Impregnated sawdust and solvents	0.00003 & 0.00145
10	Solvents	0.00029 & 0.00057
11	Sludge	<0.0110
12	Car waste and sludge	0.0036 & 0.07 & 0.0032

For other emissions, the European Commission and CEMBUREAU summarize assumed impacts of waste co-processing as follows (CEMBUREAU 2009; EIPPCB 2010):

- Dust emissions are unaffected by co-processing wastes.
- The alkaline kiln environment removes any traces of HCl and HF produced during firing.
- CO is largely unaffected.
- There is no correlation between the use of alternative fuels and TOC emissions levels.

Table 17 shows an example of using RDF as a fuel source on the emissions profile of a typical cement kiln.

Table 17. Example of emissions profile from a cement kiln using RDF (Stantec 2011)²⁰

Parameter	Measure	Individual Measurements	
		No Utilization of Wastes	Utilization of Wastes
Total Particulate	mg/m ³	2.8 – 12.90	12.0 – 15.900
HCl	mg/m ³	0.88 – 5.93	0.87 – 1.320
SO _x	mg/m ³	714 – 878.00	311 – 328.000
HF	mg/m ³	0.13 – 0.23	0.02 – 0.040
NO _x	mg/m ³	789 – 835.00	406 – 560.000
Total Carbon	mg/m ³	11.7 – 23.20	5.7 – 7.100
PAHs *	mg/m ³	–	0.003
Benzene	mg/m ³	0.27 – 0.540	0.45 – 0.550
Cd	mg/m ³	<0.005	<0.007
Tl	mg/m ³	<0.005	<0.005
Hg	mg/m ³	0.014 – 0.044	0.003 – 0.006
Sum of Sb, As, Pb, Cr, Co, Cu, Mn, Ni, V, Sn	mg/m ³	<0.300	<0.500
PCDD/PCDF, I-TEQ	mg/m ³	0.001 – 0.002	0.005 – 0.006

* PAH = polycyclic aromatic hydrocarbon

4.5.2. Emissions Control Techniques

Continuous measurement is the BAT to accurately quantify the following emissions parameters: exhaust volume, humidity, temperature at particulate matter control device inlet, dust/particulate matter, O₂, NO_x, dust, SO₂, CO. Regular, periodic monitoring is the BAT for the following substances: metals and their compounds,²¹ total organic carbon/organic components, HCl, HF, NH₃, PCDD/PCDF. Measurements of the following items might be required occasionally under special operating conditions (Stockholm Convention 2006):

- Destruction and removal efficiency of POPs in cement kilns

²⁰ Note: although the report cited does not specify the original sources of the waste in each application, RDF in Germany is generally derived from processing MSW materials (not including specialized waste streams such as construction/demolition materials). Also it should be noted that although the monitoring approach for each parameter is not described in the report, cement kilns in the EU and North America typically use CEMs for parameters such as SO_x and NO_x and periodic stack testing for other parameters (PAHs, metals).

²¹ It is especially important to measure metals when wastes with higher metal content are used as raw materials or fuels.

- Benzene, toluene, xylene
- Polycyclic aromatic hydrocarbons (PAHs)
- Other organic pollutants (principal organic hazardous constituents, e.g., chlorobenzenes, PCBs including coplanar congeners, chloronaphthalenes).

Figure 43 shows an overview of measurement points for cement plant emissions. Emissions control in cement kilns primarily uses bag houses to capture particulate matter from the flue gas; this also controls emissions of most heavy metals. More modern facilities or retrofitted plants may be equipped with NOx control, specifically Selective Non-Catalytic Reduction (SNCR). Emissions of other parameters, such as POPs or acid gases, are generally controlled through the operating characteristics of cement facilities (Stantec 2011).

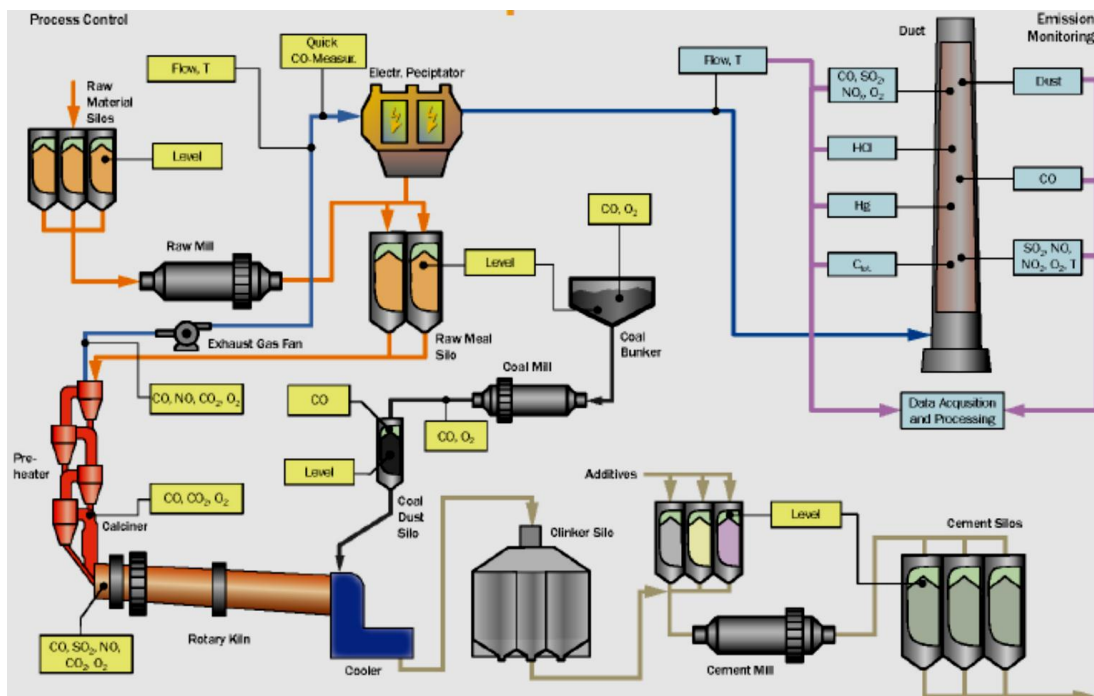

Figure 43. Overview of measurement points in a cement plant (Kolyfetis 2007)

Greer (2003) identifies existing and potential control technologies for gaseous pollutants from Portland cement manufacturing (Appendix 6). Karstensen (2007a and 2008) also explains emissions control technologies for the cement industry. IPPC provides the BAT for emissions control and associated emission levels for the cement industry in the European Union (EIPPCB 2010). In addition, guidance on BAT for preventing or minimizing the formation and subsequent release of unintentional POPs from cement kilns that co-process hazardous waste has been published by the Stockholm Convention Secretariat (UNEP, 2007).

4.5.3. Continuous emissions monitoring system

CEMS determines gas or particulate matter concentrations or emissions rates using pollutant analyzer measurements and a conversion equation, graph, or computer program to produce results in units of the applicable emissions limit or standard. CEMS is a useful tool in gathering process emissions data to demonstrate environmental compliance and to control and optimize plant processes. CEMS is required under some of the U.S. EPA and EU regulations for either continual compliance determinations or determination of exceedances of standards (U.S. EPA 2012c).

For each pollutant and parameter identified by regulations, emissions levels and values should be assessed for scenarios that occur during kiln operation: startup, shutdown, compound or direct mode (gas passing through raw mill or direct to dust collector), and for the various raw materials and fuels mixes. The measurement ranges should be set in accordance with permit conditions and expected concentrations. Particular attention should be paid to sampling, e.g., following the sampling procedures in ISO 10396:2007 “Stationary sources emissions – Sampling for the automated determination of gas emission concentrations for permanently-installed monitoring systems” (WBCSD 2012a).

Selection of CEMS technology depends on various factors such as (SICK Sensor Intelligence, No date):

- Gas conditions
- Reliability of the analyzer according to gas conditions
- Measurement task
- Type and number of measured components
- Type of fuel
- Operation costs
- Requirements imposed by local regulations (current and future)

There are different types of CEMS. Two general categories of CEMS are extractive and in-situ technologies (Figure 44). The most widely used type of CEMS is an extractive system in which a sample of gas is continuously drawn from the process point, filtered, transported, conditioned, and presented to a gas analysis system. Gas concentrations are measured, recorded and stored as data that are used to generate reports or alarms or control an aspect of the plants' process. Hardware for an extractive CEMS generally consists of the following major subsystems (K2BW 2012):

- Sample transport and conditioning
- Sample gas analysis
- Data acquisition, reporting, and system control



Figure 44. Extractive (left) and in-situ (right) CEMS technologies (SICK Sensor Intelligence no date)

Appendix 7 gives the recommended method for using CEMS to determine each type of pollutant emitted by a cement plant. Appendix 8 presents the standards for cement plant emissions measurements.

4.6. Health and Safety Practices

It has been demonstrated that waste co-processing can be accomplished in an environmentally sound manner; however, improper design or operation can result in a threat to community and worker health. Although cement kilns have all the desirable properties for efficient thermal destruction of many hazardous wastes, many cement kilns were not designed for this purpose and require modification of the fuel injection system and construction of waste-receiving facilities before they can process wastes. These facility modifications should be carefully designed and monitored to ensure that environmental and health risks are minimized (Karstensen 2007a).

After a kiln is modified to accept wastes and a test burn has demonstrated that the system operates in a manner that protects human and environmental health, a quantitative risk assessment should be conducted to determine the potential for adverse health impacts within the community and among kiln employees. Risks associated with these four major elements of the plant process should be assessed:

1. Transportation
2. Storage and handling
3. Kiln emissions
4. Clinker contamination

The first three of these risks can be evaluated in terms of three separate components: 1) risk of toxic material release, 2) risk of human exposure, and 3) risk of adverse health effects. All types of risk related to the co-processing of wastes require knowledge of the chemical properties of the waste and of the byproducts from waste combustion. This knowledge is necessary for calculating the expected fate and transport of the pollutants in the environment (Karstensen 2007a).

Easily understandable safety and emergency instructions should be provided to employees and contractors in a timely manner before co-processing begins or before new materials are added to the system. Hazards relating to new materials should be reviewed with operating staff prior to their use in the facility. Conducting a job safety analysis can be part of identifying hazards and potential exposures, along with appropriate control practices and techniques (WBCSD 2005).

Emissions to air from waste pre-processing will depend on the types of wastes treated and the processes used. Emissions must be monitored and reported according to operating permits and applicable regulations. Abatement techniques should be in place as needed. Dust is usually reduced by bag filters. Counter measures for noise and odors should be considered. Common emission control methods for VOCs include carbon adsorption, thermal treatment and, in specific cases, biological treatment (Basel Convention 2011).

Discharges of wastewater to surface water should not result in contaminant concentrations in excess of local ambient water quality criteria. Discharges to public or private wastewater treatment systems should meet the pre-treatment and monitoring requirements of the treatment system and should not interfere, directly or indirectly, with the operation and maintenance of the system, pose a risk to worker health and safety, or adversely impact characteristics of residuals from the wastewater treatment operation (Basel Convention 2011).

If co-processing of MSW and sewage sludge is done correctly and in accordance with strict environmental and emissions regulations, it should pose no additional environmental and health risk compared to using fossil fuels. Rovira et al. (2011) conducted a study in Spain showing that the human health risks for the population living around the cement plant of Vallcarca, which co-processes sewage sludge, are comparable to those in previous studies performed when petroleum coke was exclusively used as fuel. Emissions were in both cases acceptable according to international standards (Rovira et al. 2011). Another study in Spain by Schuhmacher et al. (2009) for a different cement plant confirmed that using sewage sludge in the plant did not increase health risks related to metals and PCDD/PCDFs for individuals living in the vicinity of the plant (Schuhmacher et al. 2009).

A study by Zabaniotou and Theofilou (2008) in Cyprus assessed the effects of co-processing of wet sewage sludge (moisture content 65-70 percent) at a cement kiln. Environmental gaseous emissions were measured, with emphasis on heavy metal concentrations (especially Hg). The authors concluded that co-processing of sewage sludge does not emit PCDDs/PCDFs harmful to human health (Zabaniotou and Theofilou 2008).

It should be noted that in the above examples, the cement plants were complying with the stringent environmental and emissions standards of the respective countries and were taking necessary actions to keep the emissions below the permitted levels.

For more complete discussion of the health and safety issues related to co-processing of waste in cement plants, see GTZ/Holcim (2006). For broader information on health and safety in the cement industry, see the work of the Cement Sustainability Initiative's Task Force 3 on health and safety (WBCSD 2012b).

5. Summary

This report reviews international best practices for pre-processing and co-processing of MSW and sewage sludge in cement plants. The report explains the fundamentals of co-processing, examples of best international regulatory and institutional practices related to co-processing, and best international practices related to technological aspects of pre- and co-processing.

There are different reasons and motivation for co-processing waste in the cement industry. These include: fuel cost savings particularly in the face of the rising fuel prices, conservation of nonrenewable fossil fuels and protection of the environment from the activities associated with obtaining virgin fuels, reduction of greenhouse gas emissions, advantages of co-processing over waste incineration and landfilling, integration of waste ash into clinker, and avoidance of new investment in incinerators or landfill facilities, among others.

Different studies from around the world have shown that if co-processing of MSW and sewage sludge is done correctly and in accordance with strict environmental and emissions regulations, there is no additional environmental and health risk associated with using waste fuels compared to using fossil fuels for cement production.

The polluter pays principle must be applied to the economic analysis of co-processing. This principle holds that those who produce waste (e.g., industry) or are responsible for its handling (e.g., municipalities) are responsible for and should bear the cost for environmentally sound management of that waste.

Some policies can make the use of MSW and/or sewage sludge in cement production more economically attractive. These include restricting the landfilling of MSW and or sewage sludge, increasing fossil fuel prices, enacting a carbon tax, or enacting carbon trading schemes, among others.

Effective regulatory and institutional frameworks are critical to ensure that co-processing practices in the cement industry are not harmful to health or the environment. An integrated solid waste management model and regulations and standards related to environmental performance, product quality, operations and safety, permitting, and monitoring and reporting are key elements in a regulatory framework for a sustainable co-processing industry. Experiences around the world over several decades have resulted in effective policy measures and practices. Countries that are developing a co-processing industry can learn from these experiences, many of which are cataloged in this report, in designing and implementing an environmentally sound co-processing industry.

From the technological perspective, pre-processing and treatment of waste are often required to make the waste ready for co-processing in cement kilns. A number of retrofits are required and often new installations and technologies are needed at the plant site to enable storage, conveyance, dosing, feeding, and co-processing of MSW and sewage sludge as well as the measurement and control of

emissions. As much as possible, BATs should be applied to the pre- and co-processing processes in order to ensure that waste co-processing in the cement industry is environmentally sound.

Acknowledgments

This work was supported by the U.S. Environmental Protection Agency and the Institute for Industrial Productivity through the U.S. Department of Energy under Contract No. DE-AC02-05CH11231. The authors are grateful to Howard Klee of the World Business Council for Sustainable Development's Cement Sustainability Initiative, Suzanne Giannini-Spohn of the U.S. Environmental Protection Agency, Jigar Shah and Julia Reinaud of the Institute for Industrial Productivity, and Bruno Fux and Thomas Guillot of Holcim for their valuable support and inputs. We also would like to thank Nan Wishner for editing this report. At LBNL, we thank Cecilia Chen for helping us with formatting of the report.

References

- ALF-CEMIND. 2012. Supporting the use of alternative fuel in the cement industry-Technology guide. Available at <http://www.alf-cemind.com/cd/index.htm>
- Anlagenbau GmbH. 2012. Solar Drying of Sewage Sludge. Available at <http://www.wendewolf.com/klsbesch.php?lang=en>
- Anton, D. K. 2008. Australian Environmental Law: A Federal Overview (June). Available at SSRN: <http://ssrn.com/abstract=1141711>
- Asia Pacific Partnership Cement Task Force (APP). 2010. Project Final Report Form, Project No. CMT-07-07(3) Utilizing Biosolids in Cement Kilns. (November).
- Asia-Pacific Partnership on Clean Development and Climate (APP). 2011. Utilising Biosolids in Cement Kilns. Final Report. Available at www.asiapacificpartnership.org
- Australian Cement Industry Federation. No date. Biosolids in cement production. Available at cement.org.au/file_download/7/Biosolids
- Battelle. 2002. Toward a Sustainable Cement Industry. March.
- Basel Convention. 2011. Technical guidelines on the environmentally sound co-processing of hazardous wastes in cement kilns- Revised final version (31 October 2011). Available www.basel.int/Portals/4/.../docs/pub/.../cement/tg-cement-e.doc
- Bernard, D. 2006. "French Experience in Waste Recovery in Cement Kilns". Available at: http://www.polskicement.com.pl/4/artykuly/36_35.pdf Accessed on April 13, 2012
- Bilitewski, B., G. Härdtle, K. Marek. 1997. Waste Management. Berlin: Springer. ISBN: 3-540-59210-5.
- Bolwerk, R. n.d. "Co-Processing of Waste and Energy Efficiency By Cement Plants." Parallel Session on Innovate Energy Efficiency Examples of Different Industrial Sectors – Energy Efficiency in the Cement, Metal and Petrochemical Industry.
- Bolwerk, R., G. Ebertsch, M. Heinrich, S. Plickert, and M. Oerter. 2006. "German Contribution to the Review of the Reference Document on Best Available Techniques in the Cement and Lime Manufacturing Industries – Part II: Cement Manufacturing Industries."
- Boral Cement. 2011. Project Report: Utilizing Biosolids in Cement Kilns, Asian-Pacific Partnership on Clean Development and Climate, CMT-06-07-sub3. December.
- Busato, L.C. n.d. Dioxins and Furans in Brazil: the Formation and Emission in Cement Kilns within the Framework of the Stockholm Convention.
- Cadence. 2012a. Cadence Fuel Injector. Available at <http://www.cadencerecycling.com/fuelinjector.html>
- Campisano, K. 2011. Beneficial Use of Biosolids in Cement Production. Available at www.biosolids.com.au
- Caputo, A.C. and P.M. Pelagagge. 2002. "RDF production plants: Design and costs." Applied Thermal Engineering 22 (2002): 423–437
- CEMBUREAU (The European Cement Association). n.d.. "Lifting the waste status must be subject to strict conditions." Available at: <http://www.cembureau.eu/newsroom/article/lifting-waste-status-must-be-subject-strict-conditions> Accessed on April 13, 2012
- CEMBUREAU (The European Cement Association). 2009. Sustainable Cement Production: Co-processing of Alternative Fuels and Raw Materials in the European Cement Industry. Available at

<http://www.cembureau.be/sustainable-cement-production-co-processing-alternative-fuels-and-raw-materials-cement-industry>

CEMBUREAU (The European Cement Association). 1999. Environmental Benefits of Using Alternative Fuels in Cement Production: A life cycle approach. Available at <http://www.cembureau.be/library/cembureau-publications>

Cement Industry Federation. 2009. Australia Cement Industry Sustainability Report 2009.

Clean Air Act (CCA). 2012. Title 40: Protection of Environment. Available at:

<http://ecfr.gpoaccess.gov/cgi/t/text/text-idx?c=ecfr&sid=18c6ff99757e23f30b32ea68a15c92db&rgn=div6&view=text&node=40:6.0.1.1.1.17&idno=40> Accessed on April 13, 2012

Crous, H. 2009a. National Policy on the Thermal Treatment of General and Hazardous Waste.(March)

Crous, H. 2009b. National Policy Development Process for high Temperature Waste Incineration and AFR Co-Processing in Cement Production Final Comments and Response Report, Report No. CKAF0203V4. (September).

Department for Environment, Food and Rural Affairs (Defra). 2007. Mechanical Biological Treatment of Municipal Solid Waste. Available at <archive.defra.gov.uk/environment/waste/residual/newtech/.../mbt.pdf>

DoppstadtUS. 2012. Trommel screen. Available at

<http://www.doppstadtus.com/index.php?section=SM514&showFeatures=yes>

EIPPCB (European Integrated Pollution Prevention and Control Bureau). 2010. Reference Document on Best Available Techniques in the Cement, Lime and Magnesium Oxide Manufacturing Industries. European Commission. May. Available at <http://eippcb.jrc.es/reference/cl.html>

EIPPCB (European Integrated Pollution Prevention and Control Bureau). 2006. Reference Document on Best Available Techniques for the Waste Treatment Industries. European Commission. August. Available at <http://eippcb.jrc.es/reference/wt.html>

Enomia Research & Consulting. 2011. "Costs for Municipal Waste Management in the EU." Available at: <http://ec.europa.eu/environment/waste/studies/pdf/eucostwaste.pdf> Accessed on April 13, 2012.

Environmental Protection Agency Victoria (EPA Victoria). 2011. Environmental License: Boral Cement Limited, EM30625. Aug. 24, 2011.

European Commission. 2004. Sustainability Impact Assessment (SIA) Methodology: Towards an upgrade in 2004. SIA Methodology: Consultation Paper. D.-G. f. Trade. Brussels, EC. Available at trade.ec.europa.eu/consultations/documents/consul_114.pdf

European Commission (EC). 2006a. "Commission decision of 20/II/2006 laying down a questionnaire to be used for reporting on the implementation of Directive 2000/76/EC on the incineration of waste." Brussels, Belgium.

European Commission (EC). 2006b. "Reference Document on Best Available Techniques for Waste Treatment Industries." Available at: http://eippcb.jrc.es/reference/BREF/wt_bref_0806.pdf Access on April 13, 2012

European Commission (EC). 2006c. "Reference Document on Best Available Techniques for Waste Incineration." Available at: http://eippcb.jrc.es/reference/BREF/wi_bref_0806.pdf Access on April 13, 2012

- European Commission (EC). 2009. "Assessing Legal Compliance With and Implementation of the Waste Acceptance Criteria and Procedures by the EU-15." Available at:
http://ec.europa.eu/environment/waste/pdf/report_wac.pdf Access on April 13, 2012
- European Commission (EC). 2010. "Reference Document on Best Available Techniques in the Cement, Lime, and Magnesium Oxide Manufacturing Industries." Available at:
http://eippcb.jrc.es/reference/BREF/clm_bref_0510.pdf Access on April 13, 2012
- European Commission (EC). 2011a. "Waste Incineration." Available at:
http://europa.eu/legislation_summaries/environment/waste_management/l28072_en.htm
Accessed on April 13, 2012
- European Commission (EC). 2011b. "Integrated Pollution Prevention and Control (until 2013)." Available at: http://europa.eu/legislation_summaries/environment/waste_management/l28045_en.htm
Accessed on April 13, 2012
- European Commission (EC). 2011c. "Industrial Emissions." Available at:
http://europa.eu/legislation_summaries/environment/air_pollution/ev0027_en.htm Accessed on April 13, 2012
- European Commission (EC). 2012a. "Directive 2008/98/EC on waste (Waste Framework Directive)." Available at: <http://ec.europa.eu/environment/waste/framework/index.htm> Accessed on April 13, 2012
- European Commission (EC). 2012b. "Landfill of Waste." Available at:
http://ec.europa.eu/environment/waste/landfill_index.htm Access on April 13, 2012
- European Commission (EC). 2012c. "The Waste Incineration Directive." Available at:
<http://ec.europa.eu/environment/air/pollutants/stationary/wid/legislation.htm> Access on April 13, 2012
- European Commission (EC). 2012d. "The Industrial Emissions Directive." Available at:
<http://ec.europa.eu/environment/air/pollutants/stationary/ied/legislation.htm> Access on April 13, 2012
- European Commission (EC). 2012e. "Frequently Asked Questions Concerning Permitting". Available at:
<http://ec.europa.eu/environment/waste/framework/pdf/FAQs/FAQ%20Permitting.pdf> Accessed on April 13, 2012
- European Environment Agency. 2009. "Diverting Waste from Landfill: Effectiveness of Waste Management Policies in the European Union." Available at:
http://epp.eurostat.ec.europa.eu/portal/page/portal/waste/documents/Landfill_Directive_Report.pdf Accessed on April 13, 2012
- European Pollutant Release and Transfer Register (E-PRTR). 2011. Available at: <http://prtr.ec.europa.eu/>
Access on April 13, 2012
- European IPPC Bureau. 2003. Integrated Pollution Prevention and Control, Reference Document on the General Principles of Monitoring (July 2003). European Commission, Joint Research Centre, Institute for Prospective Technological Studies. Seville. Available from
ftp://ftp.jrc.es/pub/eippcb/doc/mon_bref_0703.pdf [Accessed 19 August 2009]
- European Union Network for the Implantation and Enforcement of Environmental Law (IMPEL Network). 1998. "IMPEL Workshop on Licensing and Enforcement Practices in Cement Plants Using Alternative Fuels." Carinthia, Austria.

- Fitzgerald, G. and N. Themelis. 2009. "Technical and Economic Impacts of Pre-shredding the MSW Feed to Moving Grate WTE Boilers." Proceedings of the 17th Annual North American Waste-to-Energy Conference NAWTEC17, Chantilly, Virginia, USA. May 18-20.
- Flaga, A. no date. Sludge drying. Institute of Heat Engineering and Air Protection, Cracow University of Technology, Poland. Available at www2.lwr.kth.se/forskningsprojekt/.../Flagasludgedrying73.pdf
- FLSmith. 2011. HOTDISC™ Combustion Device. Available at <http://www.flsmidth.com/en-US/Products/Product+Index/All+Products/Cement+Burning/Hotdisc/Hotdisc>
- Fytli, D. and A. Zabaniotou. 2008. "Utilization of sewage sludge in EU application of old and new methods—A review." *Renewable and Sustainable Energy Reviews*. Volume 12, Issue 1, January, pp. 116–140.
- Gendebien, A., A. Leavens, K. Blackmore, A. Godley, K. Lewin, K.J. Whiting, R. Davis, J. Giegrich, H. Fehrenbach, U. Gromke, N. del Bufalo, and D. Hogg. 2003. "Refuse Derived Fuel, Current Practice and Perspectives: Final Report." WRc Ref: CO5087-4.
- Genon, G. and E. Brizio. 2008. "Perspectives and limits for cement kilns as a destination for RDF." *Waste Management* 28 (2008): 2375–2385.
- GTZ/Holcim. 2008. Training Kit on Co-Processing Waste Materials in Cement Production- Brochure. Available at <http://www.coprocem.org/>
- GTZ/Holcim. 2006. Guidelines on Co-Processing Waste Materials in Cement Production. Available at <http://www.coprocem.org/>
- GTZ/Holcim. 2010. Exploring Co-processing as an Option for disposal of certain fractions of Municipal Solid Waste- Workshop Report. India. Available at www.hrdp-net.in/live/hrdpmp/.../wkshpreportcoprocessing.pdf
- Global Environmental Center Foundation. 2005. Eco-towns in Japan: Implications for and Lessons for Developing Countries and Cities. June.
- Gorgun E., and G. Insel. 2007. "Cost evaluation of sludge treatment options and energy recovery from wastewater treatment plant sludge treating leather tanning wastewaters." *Journal of Leather Science*, No. 1, 2007, s. 17-20.
- Greer, W.L. 2003. Interactions Among Gaseous Pollutants from Cement Manufacture and Their Control Technologies. R&D Serial No. 2728. Skokie, Illinois, USA: Portland Cement Association. Available at www.bvsde.paho.org/bvsacd/cd24/among.pdf
- Hall, J. 1999. "Ecological and economical balance for sludge management options." Proceedings of the workshop on Problems around sludge, 18-19 November, Stresa (Italy). Available at ec.europa.eu/environment/waste/sludge/pdf/workshoppart4.pdf
- Hand, A. 2007. Technology Options for the Cement Industry with the Use of Alternative Fuels. KHD Humboldt Wedag GmbH. Alf-Cemind Workshop, Athens, Greece. May 16. Available at alf-cemind.com/docs/presentations/KHD%20presentation.pdf
- Hanjie, Z. 2010. Sludge treatment to increase biogas production. Available at www.sjostadsverket.se/download/18.../LWR_EX_10_20.pdf
- Hashimoto, S., T. Fujita, Y. Ceng, and E. Nagasawa. 2010. "Realizing CO₂ emission reduction through industrial symbiosis: a cement production case study for Kawasaki." *Resources, Conservation and Recycling* (54) pp. 704-710.

- He, P. J., F. Lü, H. Zhang, L.M. Shao, D.J. Lee. 2007. "Sewage Sludge in China: Challenges Toward a Sustainable Future." *Water Practice & Technology*. doi10.2166/wpt.2007.083
- HeidelbergCement. 2011. Potential of PAD to further improve CO₂ efficient sewage sludge recovery in cement kilns. BioValor Symposium, Arnhem, the Netherlands. June. Available at www.biovalor-europe.com/cms-assets/.../24887-463932.theulen.pdf
- Hempel, C. 2011. "Cement plant upgrade to reduce the primary (fossil) fuel consumption." In *Proceedings of 7th Green Cementech*, Hyderabad, India. May.
- Hock, U. 2008. "System technology for the use of alternative fuels for kiln firing in the cement industry." In *Proceedings of ASEAN Federation of Cement Manufacturers (AFCM)'s 21st technical symposium and exhibition*. Bangkok, Thailand.
- Hotta, Y. and C. Aoki-Suzuki. 2010. *Selected Case Studies of Integrated Waste Management and the 3Rs at Local Level in Japan – Yokohama and Kamakura*.
http://www.iges.or.jp/en/wmr/pdf/activity20101007/6_Hotta.pdf
- Inter-American Development Bank. 2010. *Cement Manufacturing Plant Guidelines: An Approach to Reconciling the Financing of Cement Manufacturing Plants with Climate Change Objectives*. August.
<http://idbdocs.iadb.org/wsdocs/getdocument.aspx?docnum=35601768>
- Institute for Prospective Technological Studies (IPTS). 1999. "The Incineration of Waste in Europe: Issues and Perspectives." March.
- IWA Water Wiki, 2011. *China Overview*. Available at
<http://www.iwawaterwiki.org/xwiki/bin/view/Articles/China>
- Japan Cement Association. 2010. *Waste Material Used in Cement Industry*. Available at
<http://www.jcassoc.or.jp/cement/2eng/eh3.html>
- Jensen, L.S. 2008. "Complete alternative fuel solution for cement kilns." In *Proceedings of ASEAN Federation of Cement Manufacturers (AFCM)'s 21st technical symposium and exhibition*. Bangkok, Thailand.
- K2BW. 2012. *Continuous Emission Monitoring Systems*. Available at
<http://www.k2bw.com/continuousemissionmonitor.htm>
- Karstensen, K. H. 2008. Formation, release and control of dioxins in cement kilns - A review. *Chemosphere*, 70 (2008): 543–560.
- Karstensen, K.H. 2007a. *A Literature Review on Co-processing of Alternative Fuels and Raw Materials and Hazardous Wastes in Cement Kilns*. Available at
<http://www.environment.gov.za/PolLeg/GenPolicy/2008Sep25/cement.html>
- Karstensen, K.H. 2007b. *Cement Production Technology in South Africa and an Evaluation of Their Ability to Co-Process AFRs and Treat Hazardous Wastes*. Report No. 66011-xx (November). Co-processing occurs at a small number of plants in South Africa currently, but is limited to aluminum processing wastes.
- Karstensen K.H. 2006. *Formation and Release of POPs in the Cement Industry*. Second edition. World Business Council for Sustainable Development/SINTEF.
- Kihara, Y. 2012. Associação Brasileira de Cimento Portland. Personal Communication. March.
- Kolyfetis, E. 2007. "Alternative Fuels & Raw Materials in Halyps cement." Italcementi Group. *Proceedings of the workshop on Alternative Fuels & Alternative Raw Materials in the Cement Industry*. Athens, Greece, May 16. Available at <http://www.alf-cemind.com/publications.html>

- Leong, C.C. 2008. "Solid fuel feed optimization-towards multi-fuel system." In the Proceedings of ASEAN Federation of Cement Manufacturers (AFCM)'s 21st technical symposium and exhibition. Bangkok, Thailand.
- Maringolo, V. 2007. "Use of waste-derived fuels and materials in the Brazilian cement industry," *Global Fuels Magazine* (June); pp. 33-34.
- McCarthy, J.E. (coordinator). 2005. "Clean Air Act: A Summary of the Act and Its Major Requirements." Available at: <http://fpc.state.gov/documents/organization/47810.pdf> Accessed on April 13, 2012
- McIlveen-Wright, D. R., Y. Huang, S. Rezvani, Y. Wang. 2007. "A technical and environmental analysis of co-combustion of coal and biomass in fluidised bed technologies." *Fuel* 86(14): 2032-2042.
- McGrath, B. 2012. Technical Manager, Boral Cement. Personal Communication. April.
- Memon, M.A. no date. "Integrated Solid Waste Management." Presentation at the International Environmental Technology Center. Osaka, Japan.
- Milieu Law & Policy Consulting Ltd (Milieu). 2011. "Provisions on Penalties Related to Legislation on Industrial Installations: Document on Good Practices." October. Brussels, Belgium.
- Milieu Ltd, WRc and RPA. 2008. Environmental, economic and social impacts of the use of sewage sludge on land Final Report Part I: Overview Report. Available at ec.europa.eu/environment/waste/sludge/pdf/part_i_report.pdf
- Mineral Production Association Cement (MPA Cement). 2009. Performance 2008 : a sector plan report from the UK cement industry. Available at http://cement.mineralproducts.org/documents/MPAC_Performance_2008.pdf
- Mokrzycki, E., A. Uliasz-Bochenczyk, M. Sarna. 2003. "Use of alternative fuels in the Polish cement industry." *Applied Energy* 74(1-2): 101-111.
- Murray, A. and L. Price. 2008. Use of Alternative Fuels in Cement Manufacture: Analysis of Fuel Characteristics and Feasibility for Use in the Chinese Cement Sector. Ernest Orlando Lawrence Berkeley National Laboratory, U.S. Department of Energy. Available at <http://china.lbl.gov/publications/use-alternative-fuels-cement-manufacture-analysis-fuel-characteristics-and-feasibility->
- Nakamura, Y. 2007. "Waste Management and Recycling Business in the United States and Japan" USJP Occasional Paper 07-09. Cambridge MA: Harvard University.
- National Bureau of Statistics (NBS). 2005-2011. China Energy Statistical Yearbook (various years). Beijing: China Statistics Press.
- Nithikul, J. 2007. Potential of refused derived fuel production from Bangkok municipal solid waste. Masters of Engineering thesis. Available at www.faculty.ait.ac.th/visu/Data/.../Jidapa%20Thesis%2012-12-07.pdf
- Onaka, T. 2000. "Sewage can make Portland cement: a new technology for ultimate reuse of sewage sludge." *Water Science and Technology* Vol. 41 No 8, pp 93-98.
- Organization for Economic Cooperation and Development (OECD). 2010. OECD Environmental Performance Reviews: Japan 2010.
- Ozaki, M., A. Miyamoto. 2007. "Utilization of Melt-solidified Slag from Sewage Sludge as Construction Material." Available at: <http://www.pwri.go.jp/eng/activity/pdf/reports/ozaki.070603.pdf> Accessed on April 12, 2012
- Peltier, R. 2003. "Mercury removal standards are coming. Where's the technology?" *Power* 147(4): 40.

- Portland Cement Association (PCA). 2012. Cement and Concrete Basics: Manufacture of Portland Cement. Available at http://www.cement.org/basics/concretebasics_history.asp
- Reinhard, J.D. 2008. "Preparing and handling of RDF for the cement industry." In Proceedings of ASEAN Federation of Cement Manufacturers (AFCM)'s 21st technical symposium and exhibition. Bangkok, Thailand.
- Reijnders, L. 2007. "The cement industry as a scavenger in industrial ecology and the management of hazardous substances." *Journal of Industrial Ecology* 11(3): 15- 25.
- Reimann, D.O. 1999. "Problems about sewage sludge incineration" Proceedings of the Workshop on Problems around Sludge." Stresa, Italy. November 18-19. Available at ec.europa.eu/environment/waste/sludge/pdf/workshoppart4.pdf
- Rovira, J., M. Mari, M. Nadal, M. Schuhmacher, J.L. Domingo. 2011. "Use of sewage sludge as secondary fuel in a cement plant: human health risks." *Environment International* 37 (2011): 105–111.
- Schneider, M, K. Kuhlmann, F. Söllenböhmer. 1996. "PCDD/F–Emissions from German Cement Clinker Kilns." *Organohalogen Compounds*, Volume 27.
- Schenck Process. 2009. FUEL – MASTER: Solutions for reliable feeding of alternative fuels. In Proceedings of 5th Green Cementech, Hyderabad, India. May.
- Schu, R. 2008. Low Temperature Drying as Key Technology for Waste Recycling. Second international Symposium on Energy from Biomass and Waste. Venice, Italy. Available at http://www.ecoenergy.de/go_public/freigegeben/Low_temperature_drying_R.Schu_Venice2008_Publication.pdf
- Schuhmacher, M., M. Nadal, J.L.Domingo. 2009. "Environmental monitoring of PCDD/Fs and metals in the vicinity of a cement plant after using sewage sludge as a secondary fuel." *Chemosphere*. Volume 74, Issue 11, March, pp. 1502–1508.
- Seemann, A. 2007. "Co-incineration of Municipal Solid Waste in Cement Industry.: Proceedings of the International Conference on Sustainable Solid Waste Management, Chennai, India. September 5-7. pp. 348-355.
- Shih, P., J. Chang, H. Lu, L. Chiang. 2005. "Reuse of heavy metal-containing sludge in cement production." *Cement and Concrete Research* 35(11): 2110-2115.
- SICK Sensor Intelligence. No date. Presentation on continuous emission monitoring system for cement plants. Available at <http://www.sick.com>.
- South Africa Department of Environmental Affairs. 2009. National Environmental Management: Waste Act, 2008 (Act No. 59 of 2008) National Policy on Thermal Treatment of General and Hazardous Waste. 24 July 2009.
- Stantec, 2011. Waste to Energy: a Technical Review of Municipal Solid Waste Thermal Treatment Practices. Available at <http://www.bcbioenergy.com/resources/industry-resources/>
- Stasta, P., J. Boran, L. Bebar, P. Stehlik, J. Oral. 2006. "Thermal processing of sewage sludge." *Applied Thermal Engineering* 26 (2006): 1420–1426.
- Stehlík P., P. Šasta, J. Borá, L. Houdková, V. Ucekaj, L. Bébar, M. Šarlej. No date. Waste as alternative fuel. Institute of Process and Environmental Engineering, Brno University of Technology, Czech Republic.. Available at www.cpi.umist.ac.uk/eminent/.../VUT_Waste_as_alternative_fuel.pdf
- Steiner, M., A. Montangero, D. Koné, M. Strauss. 2002. Economic aspects of low-cost faecal sludge management. Estimation of collection, haulage, treatment and disposal /reuse cost,

- EAWAG/SANDEC, Dübendorf, Switzerland. Available at www.eawag.ch/forschung/sandec/.../ewm/dl/FSM_cost_report.pdf
- Stockholm Convention. 2006. Cement Kilns Firing Hazardous Waste - Draft 15. April 2006. Available at www.pops.int/documents/.../Book%206%20Cement%20Kilns.doc
- Swiss Agency for the Environment, Forests and Landscape (SAEFL). 2005. "Guidelines: Disposal of Wastes in Cement Plants." Updated Edition.
- Swiss Confederation. 2009. "National Reporting to CSD 18/19 by Switzerland: Waste Management".
- Taiheiyō Cement Company. 2006. Utilization of Municipal Solid Wastes in the Cement Manufacturing Process: Two Examples from Taiheiyō Cement Corporation. Presentation given at the IEA – Cement Energy Efficiency Workshop, Paris, Sept. 4-5.
- Takx, A. 2002. Sewage sludge as a secondary fuel and raw material at ENCI. Available at <http://www.eco-responsibility.nl/nl/artikelen/co-processing>
- TA Luft (Technical Instructions on Air Quality Control). 2002. First General Administrative Regulation Pertaining the Federal Emission Control Act. Germany. Available at: http://www.bmu.de/english/air_pollution_control/ta_luft/doc/36958.php Accessed on April 12, 2012
- Taruya, T., N. Okuno, K. Kanaya. 2002. Reuse of sewage sludge as raw material of Portland cement in Japan. *Water Science and Technology*, 46 (10) (2002): 255–258
- United Nations Framework Convention on Climate Change (UNFCCC). 2010. Dehydration and incineration of sewage sludge in Singapore. CDM project design document. Available at <http://cdm.unfccc.int/Projects/DB/JCI1255679005.07>
- United Nations Environment Programme (UNEP). 2007. Guidelines on Best Available Techniques and Provisional Guidance on Best Environmental Practices Relevant to Article 5 and Annex C of the Stockholm Convention on Persistent Organic Pollutants: Cement Kilns Firing Hazardous Waste. Geneva, Switzerland: UNEP.
- United Nations Environment Programme (UNEP) Chemicals. 2005. Standardized Toolkit for Identification and Quantification of Dioxin and Furan Releases. Geneva, Switzerland. Available at www.chem.unep.ch/pops/pcdd_activities/toolkit/.../Toolkit_2003.pdf
- Unitherm Cemcon. 2012. Pneumo Injector V2 for solid alternative fuels. Available at http://www.unitherm.co.at/en/pneumo_injector_v2.html
- U.K. Department for Environment, Food and Rural Affairs (Defra). 2006. "Implementation on Directive 2000/76/EC within the United Kingdom."
- U.S. Environmental Protection Agency (EPA). 2005. "National Emission Standards for Hazardous Air Pollutants: Final Standards for Hazardous Air Pollutants for Hazardous Waste Combustors." Available at: <http://www.epa.gov/osw/laws-regs/state/revision/frs/fr212.pdf> Access on April 13, 2012
- U.S. Environmental Protection Agency (EPA). 2008. "Cement Sector Trends in Beneficial Use of Alternative Fuels and Raw Materials (Revised Draft)." Available at: <http://www.epa.gov/sectors/pdf/cement-sector-report.pdf> Access on April 13, 2012
- U.S. Environmental Protection Agency (EPA). 2009. "U.S. Environmental Protection Agency - October 2007 FY08 – FY10 Compliance and Enforcement National Priority: Clean Air Act, New Source Review/Prevention of Significant Deterioration." Available at:

- <http://www.epa.gov/compliance/resources/publications/data/planning/priorities/fy2008prioritycaansrpsd.pdf> Access on April 13, 2012
- U.S. Environmental Protection Agency (EPA). 2010. "CAA Statute, Regulations, & Enforcement." Available at: <http://www.epa.gov/compliance/civil/caa/caaenfstatreq.html> Access on April 13, 2012
- U.S. Environmental Protection Agency (EPA). 2011a. "National Ambient Air Quality Standards (NAAQS)." Available at: <http://www.epa.gov/air/criteria.html> Access on April 13, 2012
- U.S. Environmental Protection Agency (EPA). 2011b. "Taking Toxics Out of the Air." Available at: <http://www.epa.gov/air/toxicair/takingtoxics/p1.html#7> Access on April 13, 2012
- U.S. Environmental Protection Agency (EPA). 2011c. "Standards of Performance for New Stationary Sources and Emission Guidelines for Existing Source: Commercial and Industrial Solid Waste Incineration Unit." Available at: <http://www.epa.gov/ttn/atw/129/ciwi/fr21mr11.pdf> Access on April 13, 2012
- U.S. Environmental Protection Agency (EPA). 2011d. "Industrial, Commercial, and Institutional Boilers and Process Heaters and Commercial and Industrial Solid Waste Incineration Units:Final rules; Delay of effective dates." Available at: <http://www.epa.gov/ttn/atw/boiler/fr18my11.pdf> Access on April 13, 2012
- U.S. Environmental Protection Agency (EPA). 2011e. "Commercial and Industrial Solid Waste Incineration Units: Reconsideration and Proposed Amendments; Non-Hazardous Secondary Materials That Are Solid Waste; Proposed Rule." Available at: <http://www.epa.gov/ttn/atw/129/ciwi/fr23de11.pdf> Access on April 13, 2012
- U.S. Environmental Protection Agency (EPA). 2011f. "CAA National Enforcement Programs: MACT Air Toxics Enforcement." Available at: <http://www.epa.gov/compliance/civil/caa/caaenfprog.html#MACT> Access on April 13, 2012
- U.S. Environmental Protection Agency (EPA). 2011g. "Cement Manufacturing Enforcement Initiative." Available at: <http://www.epa.gov/compliance/civil/caa/cement/index.html> Access on April 13, 2012
- U.S. Environmental Protection Agency (EPA). 2011h. "National Enforcement Initiatives for Fiscal Years 2008 - 2010: Clean Air Act: New Source Review/Prevention of Significant Deterioration." Available at: <http://www.epa.gov/compliance/data/planning/priorities/caansrpsd.html> Access on April 13, 2012
- U.S. Environmental Protection Agency (U.S. EPA). 2012a. Municipal Solid Waste. Available at <http://www.epa.gov/osw/nonhaz/municipal/>
- U.S. Environmental Protection Agency (U.S. EPA). 2012b. Energy recovery from waste. Available at <http://www.epa.gov/osw/nonhaz/municipal/wte/index.htm>
- U.S. Environmental Protection Agency (U.S. EPA). 2012c. Continuous Emission Monitoring - Information, Guidance, etc. Available at <http://www.epa.gov/ttn/emc/cem.html>
- U.S. Environmental Protection Agency (U.S. EPA). 2012d. Cement Manufacturing Enforcement Initiative. Available at <http://www.epa.gov/compliance/civil/caa/cement/index.html>
- U.S. Environmental Protection Agency (U.S. EPA). 2012e. About Air Toxics. Available at <http://www.epa.gov/ttn/atw/allabout.html>
- U.S. Environmental Protection Agency (U.S. EPA). 2008. Cement Sector Trends in Beneficial Use of Alternative Fuels and Raw Materials-Revised Draft. Available at <http://www.epa.gov/sectors/pdf/cement-sector-report.pdf>

- Van Oss, H. 2005. Background Facts and Issues Concerning Cement and Cement Data. U.S. Department of the Interior, U.S. Geological Survey. Available at pubs.usgs.gov/of/2005/1152/2005-1152.pdf
- Vandenbroek International, 2012. Waste Drying & Municipal Waste Treatment. Available at <http://www.vadeb.com/applications/msw-drying-rdf/>
- Verein Deutscher Zementwerke (VDZ). 2010. "Activity Report 2007-2009." Düsseldorf, Germany. Available at: http://www.vdz-online.de/fileadmin/gruppen/vdz/3LiteraturRecherche/TB07_09/VDZ_ActivityReport07_09.pdf Accessed on April 13, 2012
- World Business Council for Sustainable Development (WBCSD). 2012a. Guidelines for Emissions Monitoring and Reporting in the Cement Industry. Version 2.0 (2012); Final Draft 5.9.1: 19 January 2012.
- World Business Council for Sustainable Development (WBCSD). 2012b. Employee Health and Safety. Available at <http://www.wbcdcement.org/index.php/key-issues/health-and-safety>
- World Business Council for Sustainable Development (WBCSD). 2009. Cement Sustainability Initiative: Cement Industry Energy and CO₂ Performance "Getting the Numbers Right." Available at <http://www.wbcd.org/DocRoot/IV5ZFD9dESJoSb3h7kxM/csi-gnrreport-withlabel.pdf>.
- World Business Council for Sustainable Development (WBCSD). 2005. Guidelines for the Selection and Use of Fuels and Raw Materials in the Cement Manufacturing Process. Available at <http://www.wbcdcement.org/index.php/publications>
- World Business Council for Sustainable Development (WBCSD). 2002. Toward a Sustainable Cement Industry: Environment, Health, and Safety Performance Improvement. Available at www.wbcd.org/web/projects/cement/tf3/sub_ehs.pdf
- World Business Council for Sustainable Development (WBCSD)/International Energy Agency (IEA). 2009a. Cement Technology Roadmap 2009 - Carbon emissions reductions up to 2050. Available at www.iea.org/papers/2009/Cement_Roadmap.pdf
- World Business Council for Sustainable Development (WBCSD)/International Energy Agency (IEA). 2009b. Cement roadmap targets. Available at www.iea.org/papers/2009/Cement_Roadmap_targets_viewing.pdf
- Worrell, E., C. Galitsky. 2004. Energy Efficiency Improvement and Cost Saving Opportunities for Cement Making. An ENERGY STAR® Guide for Energy and Plant Managers. Available at www.energystar.gov/ia/business/industry/LBNL-54036.pdf
- WWF. 2008. A blueprint for a climate friendly cement industry. Available at http://wwf.panda.org/about_our_earth/all_publications/?151621/A-blueprint-for-a-climate-friendly-cement-industry
- Zabaniotou, A. and Theofilou, C. 2008. Green energy at cement kiln in Cyprus—Use of sewage sludge as a conventional fuel substitute. *Renewable and Sustainable Energy Reviews* 12 (2008): 531–541.
- Zhanga, D. Q., S.K. Tanb, R.M. Gersbergc. 2010. "Municipal solid waste management in China: Status, problems and challenges." *Journal of Environmental Management*. Volume 91, Issue 8, August, pp. 1623–1633.

Appendices

Appendix 1. Cement Production Processes and Energy Use

Mining and Quarrying

The most common raw materials used in cement production are limestone, chalk, and clay, with limestone or chalk forming the majority of the ingredients in cement. These materials are usually extracted from a quarry adjacent or very close to the cement plant. Limestone provides calcium oxide and some of the other oxides; and clay, shale, and other materials provide most of the silicon, aluminum, and iron oxides required for the manufacture of cement. Approximately 5 percent of CO₂ emissions from cement production are associated with quarry mining and transportation (WWF 2008).

Raw Material Grinding and Preparation

Grinding raw materials for cement is an electricity-intensive step generally requiring about 25 to 35 kilowatt-hours (kWh)/t raw material. Grinding differs according to the type of process used in clinker production. In dry processing, the raw materials are ground into a flowable powder in horizontal ball mills, vertical roller mills, or roller presses. Materials might be dried using waste heat from the kiln exhaust or clinker cooler hood, or auxiliary heat from a stand-alone air heater. The moisture content in the dry feed is typically around 0.5 percent but can range from 0 to 0.7 percent. When raw materials are very moist, as is the case in some countries and regions, wet processing may be preferable. In the wet process, raw materials are ground in a ball or tube mill with the addition of water to produce a slurry whose water content ranges from 24 to 48 percent but is typically 36 percent (Worrell and Galitsky 2004).

Clinker Production

Clinker production is the most energy-intensive stage in cement production, accounting for more than 90 percent of total cement industry energy use and virtually all of the fuel use. Kiln systems evaporate the inherent water in the raw meal, calcine the carbonate constituents (calcination),²² and form cement minerals (clinkerization). The main type of high-heat or pyroprocessing kiln used today is the dry rotary kiln. A dry rotary kiln uses feed material with low moisture content (0.5 percent). The first dry kiln process was developed in the U.S. and did not involve preheating. Later developments added multi-stage suspension preheaters (cyclones) or shaft preheaters. More recently, precalciner technology was developed in which a second combustion chamber is added between the kiln and a conventional preheater that allows for further reduction of kiln fuel requirements. The typical fuel consumption of a dry kiln with four, five, or six-stage preheating can vary between 2.9 and 3.5 GJ/t clinker, and almost all the process-related CO₂ emissions from cement production are associated with calcination during clinker production. Once the clinker is formed in the rotary kiln, it is cooled rapidly to minimize the formation of glass and ensure the maximum yield of alite (tricalcium silicate), an important component for the hardening properties of cement. The main cooling technologies are the grate cooler or the tube or

²² Calcination is the process of heating a substance to a high temperature that is below the substance's melting or fusing point, to change the substance's physical or chemical constitution.

planetary cooler. In the grate cooler, which is most common today, the clinker is transported over a reciprocating grate through which air flows perpendicular to the clinker flow (Worrell and Galitsky 2004).

Finish Grinding

To produce powdered cement, nodules of clinker are finely ground in ball mills, ball mills combined with roller presses, roller mills, or roller presses. At this stage, 3 to 5 percent gypsum is added to control the setting properties of the cement. The amount of electricity used for raw meal and finish grinding depends strongly on the hardness of the materials (limestone, clinker, pozzolana, etc.) and the desired fineness of the cement as well as the amount of additive. Blast furnace slag is harder to grind and thus requires more grinding power. Traditionally, ball mills are used in finish grinding, but many plants use vertical roller mills as well. Modern state-of-the-art approaches utilize a high-pressure roller mill or horizontal roller mill (e.g., Horomill®). Finished cement is stored in silos; tested; and bagged or shipped in bulk on cement trucks, railcars, barges, or ships (Worrell and Galitsky 2004). Figure A.1 shows the steps of the cement production process using the NSP kiln.²³

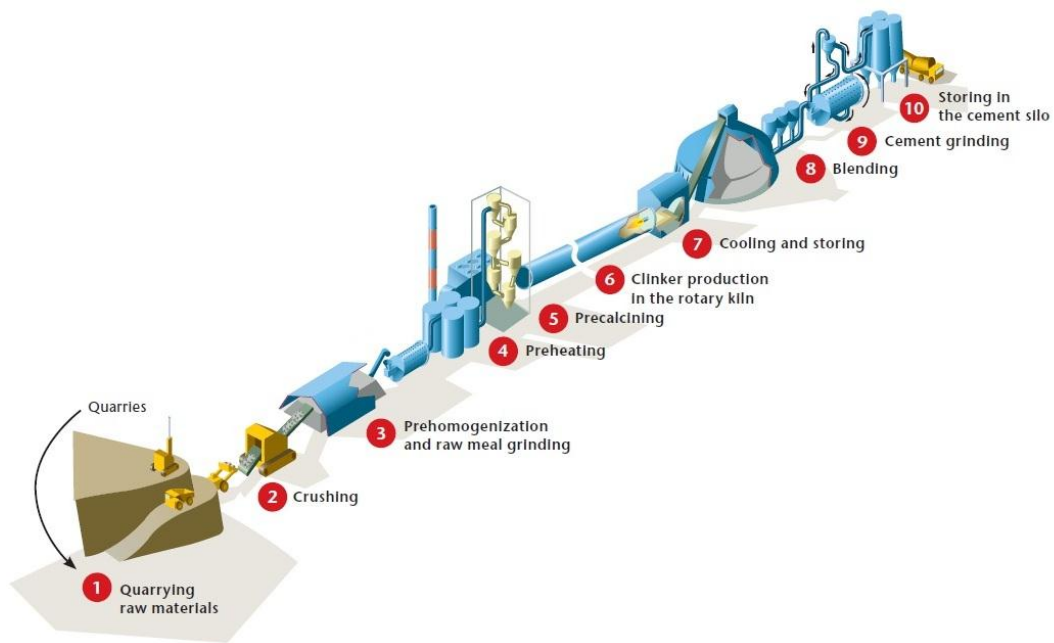
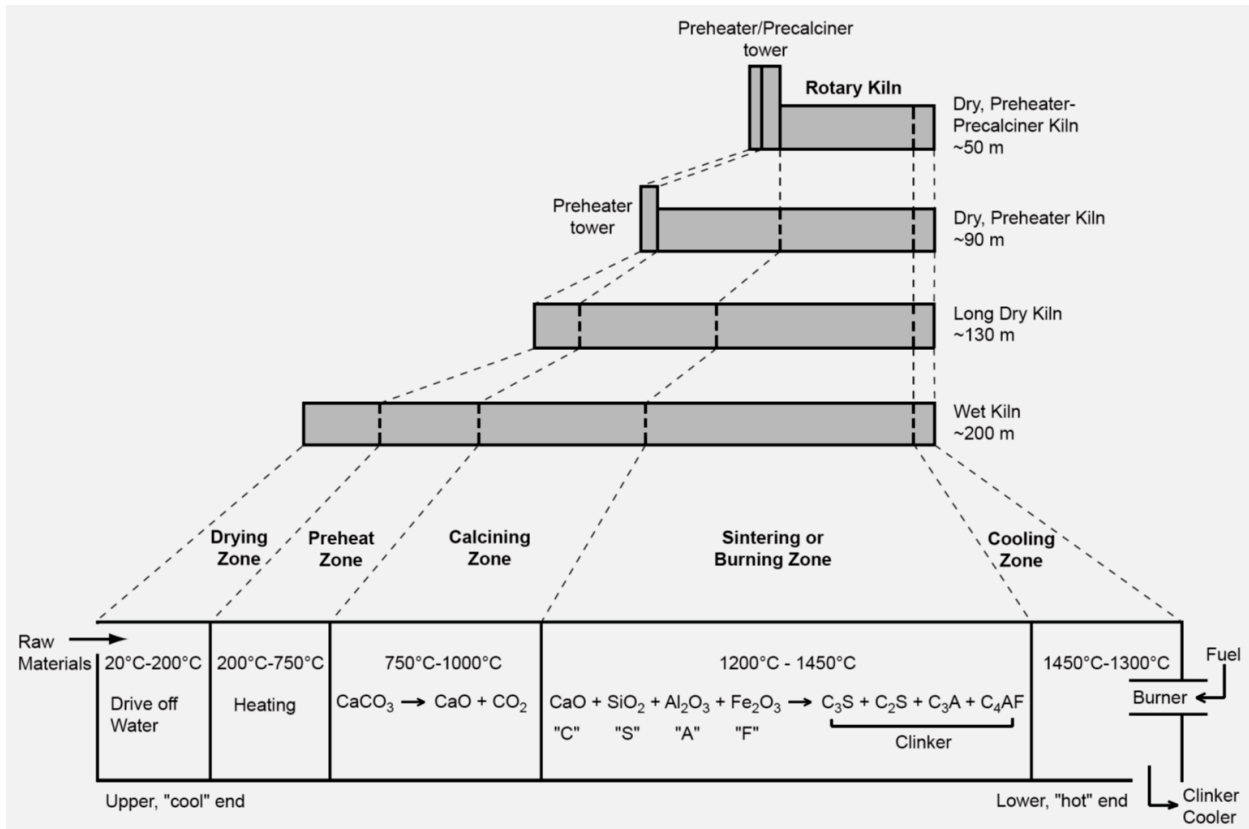

Figure A.1. Steps in the cement production process using the new suspension preheater and precalciner kiln (WBCSD/IEA 2009a)

²³ This description of the cement production process is partially excerpted from Worrell and Galitsky (2004).

Appendix 2. Diagram of Reaction Zones for Different Kiln Technologies



Source: Van Oss (2005)

Appendix 3. Example of an Accept-Refuse Chart

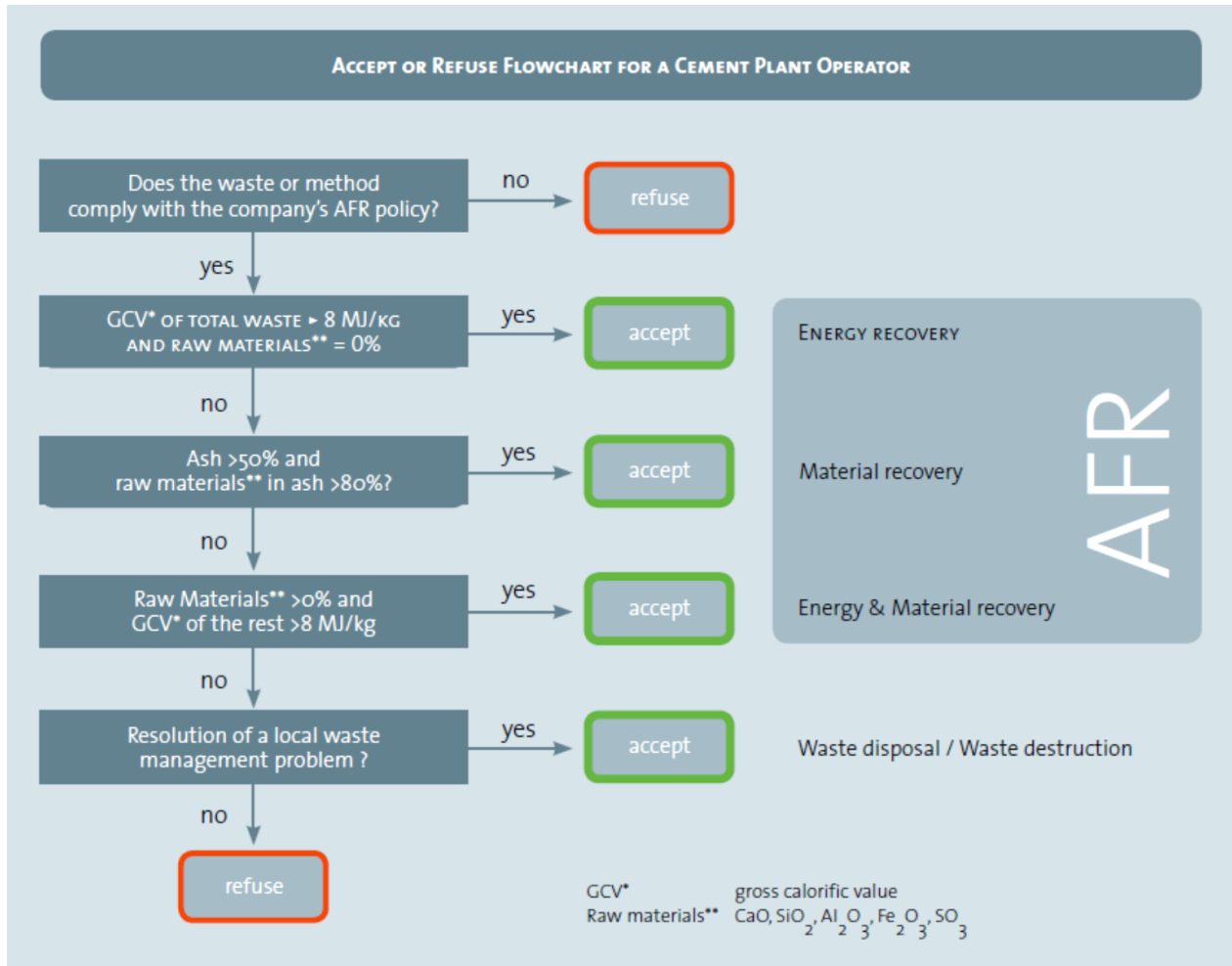

Source: GTZ/Holcim (2006)

Appendix 4. Performance and Cost of RDF Production Lines

Table A.4.1. Performance and cost of fluff RDF production lines with varying input waste mixes (Caputo and Pelagagge 2002)

Line #	Line configuration	MSW input fraction (%)	Efficiency (%)	Moisture (%)	Ash (%)	LHV (kcal/kg RDF)	Production cost (Euro/t RDF)
1	PT-HS-MS-S-T-M-T	100	18.3	8.76	6.0	3478	16.56
2	T-HS-MS-S-T-M-T	100	24.9	9.05	6.67	3388	15.07
3	T-HS-MS-S-T-MS-M-T	100	24.3	9.0	6.28	3403	15.64
4	T-HS-MS-S-T-MS-M-T-MS	100	23.8	9.0	6.22	3406	16.18
5	T-HS-MS-S-T-ECS-M-T	100	24.1	9.1	5.3	3434	15.93
6	T-HS-ECS-S-T-ECS-M-T	100	24.0	9.1	5.28	3438	16.19
7	T-HS-MS-S-T-S-T-M-T	100	20.9	6.9	6.42	3546	20.15
8	T-HS-MS-S-T-MS-S-T-M-T	100	20.5	6.9	6.06	3559	20.78
9	T-HS-MS-S-T-ECS-S-T-M-T	100	20.3	6.9	5.23	3590	21.18
10	S-T-MS-M-T	100	30.7	10.7	8.5	3152	9.48
11	S-T-MS-S-T-M-T	100	24.7	7.4	7.7	3409	12.45
12	S-T-MS-S-T-MS-M-T	100	24.1	7.4	7.3	3424	12.97
13	S-T-ECS-S-T-MS-M-T	100	23.7	7.4	5.5	3488	13.37
14	S-T-ECS-S-T-ECS-M-T	100	23.6	7.4	5.3	3494	13.59
2	T-HS-MS-S-T-M-T	90	31.9	7.8	6.15	3792	12.26
7	T-HS-MS-S-T-S-T-M-T	90	28.2	6.0	5.9	3961	15.50
8	T-HS-MS-S-T-MS-S-T-M-T	90	27.8	5.9	5.7	3977	15.32
9	T-HS-MS-S-T-ECS-S-T-M-T	90	27.6	6.0	5.1	3999	15.60
15	T-HS-ECS-S-T-ECS-S-T-M-T	90	27.6	6.0	5.1	4001	15.76
10	S-T-MS-M-T	90	37.3	9.65	7.6	3544	9.26
11	S-T-MS-S-T-M-T	90	31.8	6.8	6.9	3804	10.17
2	T-HS-MS-S-T-M-T ^a	80	38.9	7.1	5.83	4050	11.85
10	S-T-MS-M-T	80	43.5	8.2	6.9	3846	9.68
11	S-T-MS-S-T-M-T	80	38.6	5.8	6.3	4083	10.19
2	T-HS-MS-S-T-M-T ^a	70	45.8	6.6	5.6	4230	10.47
10	S-T-MS-M-T	70	49.9	7.5	6.4	4060	7.54
2	T-HS-MS-S-T-M-T ^a	60	53.5	7.2	5.4	4310	9.12
10	S-T-MS-M-T	60	56.3	6.9	6.1	4225	6.82
2	T-HS-MS-S-T-M-T ^a	50	59.4	5.13	5.35	4499	8.47
10	S-T-MS-M-T	50	62.8	6.4	5.8	4355	6.12

^a Line suitable to feed a parallel compost producing plant.

ECS = eddy current separator

HS = hand sorting

LHV = low heating value

M = mill

MS = magnetic separator

PT = preliminary trommel screen

RDF – refuse-derived fuel

S = shredder

T = trommel screen

Table A.4.2. Performance and Cost of Densified RDF Production Lines with Varying Input Waste Mixes (Caputo and Pelagagge 2002)

Line #	Line configuration	MSW input fraction (%)	Efficiency (%)	Moisture (%)	LHV (kcal/kg RDF)	Production cost (Euro/t RDF)	
						Densified	Pelletized
2	T-HS-MS-S-T-M-T-DE/P ^a	80	38.9	7.1	4050	12.71	13.57
11	S-T-MS-S-T-M-T-DE/P	80	38.6	5.8	4083	11.05	11.92
2	T-HS-MS-S-T-M-T-DE/P ^a	70	45.8	6.6	4230	11.20	11.93
10	S-T-MS-M-T-DE/P	70	49.9	7.5	4060	8.21	8.88
2	T-HS-MS-S-T-M-T-DE/P ^a	60	53.5	7.2	4310	9.75	9.75
10	S-T-MS-M-T-DE/P	60	56.3	6.9	4225	7.42	7.42
2	T-HS-MS-S-T-M-T-DE/P ^a	50	59.4	5.13	4499	9.04	9.04
10	S-T-MS-M-T-DE/P	50	62.8	6.4	4355	6.65	6.65

^a Line suitable to feed a parallel compost producing plant.

DE = densifier

HS = hand sorting

LHV = low heating value

M = mill

MS = magnetic separator

MSW = municipal solid waste

P = pelletizer

RDF = refuse-derived fuel

S = shredder

T = trommel screen

Appendix 5. Flow Diagram of Sewage Sludge Pre- and Co-processing Project in Australia

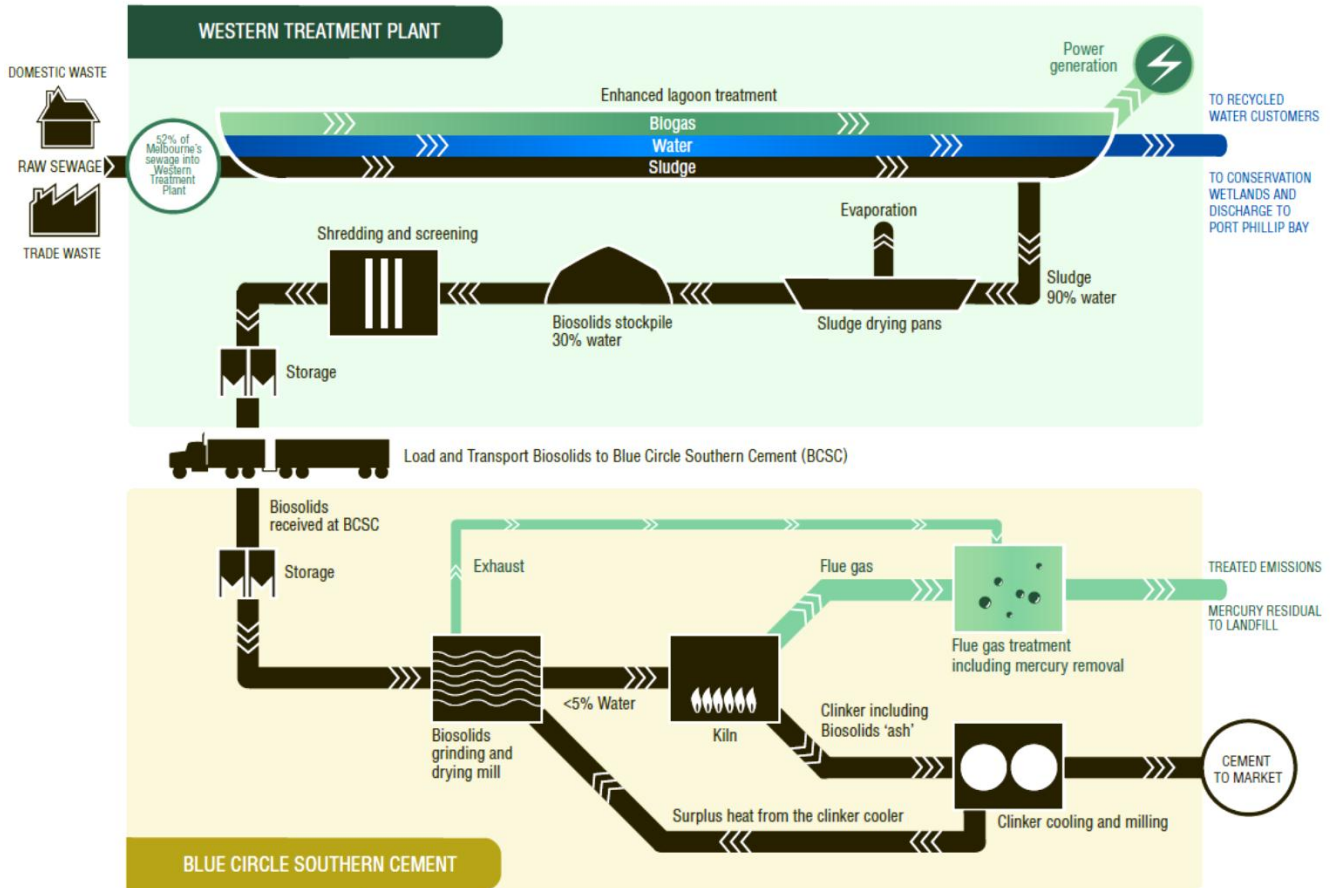

Source: Australian Cement Industry Federation (no date)

Appendix 6. Control Technologies for Gaseous Pollutants from Cement Manufacturing

Table A.6.1. Existing control technologies for gaseous pollutants from Portland cement manufacturing (Greer 2003)

Existing control technologies		Pollutant for which technology was intended	Potential effects	
			Synergetic	Counteractive
Inherent scrubbing		SO ₂	Process specific	Process specific
O ₂ / excess air control	Increase	SO ₂ , THC, CO		NOx, CO ₂
	Decrease	NOx	CO ₂	SO ₂ , CO, product color and quality
Fuel substitution (lower sulfur)		SO ₂	Fuel specific	Fuel specific
Raw material substitution containing	Lower sulfide	SO ₂	Material specific	Material specific
	Lower organics	THC, CO	Material specific	Material specific
	Lower carbonates	CO ₂	Material specific	Material specific
	Lower sulfide or chloride	AG	Material specific	Material specific
Raw material alkali/sulfur balance		SO ₂	Material specific	Material specific
In-line raw mill		SO ₂	THC, AG, NH ₃ , D/F, detached plume	THC, detached plume
Preheater upper stage hydrated lime injection		SO ₂	D/F	PM
Calcined feed recirculation		SO ₂		NOx, CO ₂
Cement kiln dust internal scrubber		SO ₂	AG, D/F	
Preheater upper stage trona injection		SO ₂	AG, D/F	CKD disposal
Calcium-based internal scrubber		SO ₂	D/F, detached plume, waste disposal	
Pyroprocessing system design		SO ₂	Process specific	Process specific
Tailpipe wet scrubber		SO ₂	NH ₃ , HCl	AG, PM, solid waste disposal, wastewater
Decrease SO ₂ generation		AG	SO ₂	
Indirect firing		NOx	CO ₂	PM
Low-NOX burner		NOx	Burner/application specific	Burner/application specific
Mid-kiln firing		NOx	Application specific	Application specific
Process improvements		NOx	Project specific	Project specific
Process control improvements		NOx	Project specific	Project specific
Low-NOX calciner		NOx		CO
Staged combustion		NOx		CO
Semi-direct firing		NOx	PM	
Mixing air fan		NOx, THC, CO	SO ₂	
Cement kiln dust insufflation		NOx		CO, CO ₂ , SO ₂
Biosolids injection		NOx		CO, NH ₃ , detached plume, metals
Inherent process characteristics (time, temperature, and turbulence)		THC	CO	
Pyroprocessing system design		THC, CO	Process specific	Process specific

Existing control technologies	Pollutant for which technology was intended	Potential effects	
		Synergetic	Counteractive
Regenerative thermal oxidizer	THC, CO	Detached plume, D/F	NOx, CO ₂ , SO ₃ , AG, waste disposal
Good combustion practice	CO	NOx, CO ₂ , SO ₂ , THC	
Improved thermal efficiency	CO ₂	Project specific	Project specific
Clinker substitution	CO ₂	Reduction in all gaseous pollutants per ton of cement produced	Reduction in all gaseous pollutants per ton of cement produced
Improved electrical efficiency	CO ₂	Reduction in all gaseous pollutants per ton of cement produced	Reduction in all gaseous pollutants per ton of cement produced
Mineralizers	CO ₂	NOx	AG
Electricity generation from waste heat	CO ₂	Reduction in all pollutants related to power generation	Reduction in all pollutants related to power generation
PMCD inlet temperature control	D/F		
Reduced residence time at temperature	D/F		

Table A.6.2. Potential control technologies for gaseous pollutants from Portland cement manufacturing (Greer 2003)

Potential control technologies	Pollutant for which technology might be intended	Potential effects	
		Synergetic	Counteractive
Mixing air fan	SO ₂ , NOx, CO, THC		
In-line raw mill hydrated lime injection	SO ₂	THC, AG, D/F, detached plume	
Fabric filter absorption	SO ₂	AG	
Sodium-based internal scrubber	SO ₂	AG, D/F, detached plume	CKD disposal
Calcium/sodium based internal scrubber	SO ₂	AG, D/F	CKD disposal
Oxygen enrichment	SO ₂ , THC, CO		NOx
	NOx	SO ₂ , CO	
Dual-alkali process (soda ash/lime)	SO ₂	AG	Waste disposal
Thermal decomposition (roasting)	SO ₂	THC	CO, NOx, CO ₂
Tailpipe dry scrubber	SO ₂ , AG	AG, THC, D/F	NOx, CO, CO ₂ , waste disposal
Cement kiln dust tailpipe scrubber	SO ₂	THC, NH ₃ , AG, detached plume	
Fuel substitution	Low nitrogen containing fuel	NOx	Fuel/process specific
	High hydrocarbon containing fuel	CO ₂	Fuel specific
Raw material substitution containing	Lower nitrogen	NOx	Material specific
	Lower ammonia	NH ₃	Material specific
	Lower D/F	D/F	Material specific
Selective noncatalytic reduction	NOx		NH ₃ , detached plume

Modified direct firing	NOx	PM	
LoTOX™ scrubber	NOx		Water discharges, ozone slip
Flue gas recirculation	NOx		CO, SO ₂
Selective catalytic reduction	NOx		NH ₃ , CO ₂ , detached plume, solid catalyst wastes
Tri-NOX® Multi-Chem wet scrubber	NOx	SO ₂ , AG	Water discharges
Water/steam injection	NOx		CO, CO ₂
Catalytic filtration	NOx		
	D/F	PM	
Non-thermal plasma	NOx	SO ₂ , THC, D/F	
Thermal desorption (roasting)	THC		SO ₂ , CO
Thermal oxidation	THC, CO	D/F	CO ₂ , NOx
Recuperative thermal oxidation	THC, CO	D/F	CO ₂ , NOx
Wet electrostatic precipitator	THC, AG	SO ₂ , NOx, PM, NH ₃ , D/F, detached plume	Waste disposal, water treatment
Ultraviolet light	THC, D/F		CO
Catalytic oxidization	THC, CO		CO ₂ , NOx
Granular activated carbon adsorption	THC, D/F	NOx, SO ₂ , metals	Waste disposal, high reagent consumption
Powdered activated carbon adsorption	THC, D/F	NOx, SO ₂ , metals	D/F, waste disposal, high reagent consumption
Electricity generation from the sun and wind	CO ₂	Reduction in all pollutants related to power generation	Reduction in all pollutants related to power generation
Tailpipe wet scrubber	NH ₃ AG	SO ₂ , THC	PM, acid mist, wastewater
Fabric filter absorption	AG	SO ₂	
Tailpipe dry bicarbonate injection	AG	SO ₂ , D/F, detached plume	Waste disposal
Temperature control	AG	SO ₂ , NH ₃ , THC, D/F, detached plume	Water/waste disposal

Appendix 7. Recommended Method for Using CEMS to Determine Each Type of Pollutant from a Cement Plant

Pollutant	Recommended method of determination
Dust Concentration <20 mg/Nm ³	Scattered light method
Dust Concentration >20 mg/Nm ³	Optical transmission method
Nitrogen oxide (NO)	NDIR (cold and hot) / FTIR / DOAS-UV
Nitrogen dioxide (NO ₂)	FTIR / NDIR (cold) and converter / Calculation*
SO ₂	NDIR (cold and hot) / FTIR I DOAS-UV
VOCs	Flame Ionization Detector (FID)

**Alternatively, default values can be used that are either based on results of spot measurements or calculated.*

NDIR: Nondispersive infrared; FTIR: Flow through infrared; UV: ultraviolet

Parameter	Recommended method of determination
O ₂	Zirconium oxide (ZRO ₂ method) / Paramagnetic method
Water content	NDIR (hot) / FTIR / Laser method / Fixed value*
Volume Flow	Ultrasonic method / Differential pressure principle
Temperature	Pt100-Sensor / In-situ analyzer implemented
Absolute Pressure	In-situ analyzer integrated / Fixed value*
Gas pressure	Separate sensor / Volume pressure) / Fixed value1 flow integrated (differential pressure) / Fixed value*

**Alternatively, default values can be used that are either based on results of spot measurements or calculated.*

Source: WBCSD (2012a)

Appendix 8. Standards for Cement Plant Emissions Measurements: Sampling and Analyses

POLLUTANT	STANDARD / REFERENCE METHOD	SPOT/CONTINUOUS	SAMPLING/ ANALYSIS
Dust	EN 13284-1:2002	Spot	Sampling and analysis
	US EPA method 5, 5i, 17	Spot	
	ISO 9096:2003	Spot	
	ISO 12141:2002	Spot	
Nitrogen Oxides (NO _x /NO ₂)	EN 14792:2006	Continuous	Sampling and analysis
	US EPA method 7 E	Continuous	
	US EPA method 7 (A to D)	Spot	
	ISO 10849:1996	Continuous	
	ISO 11564:1998	Spot	
Sulfur Oxides (SO _x /SO ₂)	EN 14791:2006	Spot	Sampling and analysis
	US EPA method 6 C	Continuous	
	US EPA 6, 6A, 8	Spot	
	ISO 7935:1992	Continuous	
	ISO 7934:1998	Spot	
	ISO 11632:1998	Spot	
Hg	EN 13211:2001-2005	Spot	Sampling
	EN 14884:2005	Continuous	Sampling and analysis
	US EPA method 29, 101A	Spot	
Heavy Metals	EN 14385:2004	Spot	Sampling and analysis
	US EPA method 29	Spot	
VOC / THC	EN 13649:2002	Spot	Sampling and analysis
	EN 12619:2000	Continuous	
	US EPA method 25A	Continuous	
PCDD/F	EN 1948-1/2/3/4:2006	Spot	Sampling and analysis
	US EPA method 23	Spot	
PARAMETER	STANDARD / REFERENCE METHOD	SPOT/CONTINUOUS	SAMPLING/ ANALYSIS
GAS VELOCITY, MOISTURE AND OXYGEN			
Flow Rate & Velocity	US EPA 1, 2	Continuous	measurement
	ISO 10780:1994	Continuous	
Moisture (Water vapor)	EN 14790:2005	Spot	Sampling and analysis
	US EPA 4	Spot	
Oxygen	EN 14789:2006	Spot	Sampling
	US EPA 3, 3B	Spot	Sampling and analysis
	US EPA 3A	Continuous	

Source: WBCSD (2012a)

Appendix 9. Short List of Pre- and Co-processing Technology Providers for Alternative Fuels in the Cement Industry

Below is a list of some providers of technology for pre- and co-processing of alternative fuels in the cement industry. This list is not exhaustive.

Pre-processing of MSW and sewage sludge

- Anlagenbau GmbH (<http://www.wendewolf.com/klsbesch.php?lang=en>)
- Buss-SMS-Canzler (<http://www.sms-vt.com/index.php?id=631&L=1>)
- Continental Biomass Industries (<http://www.cbi-inc.com/applications/msw.aspx>)
- DoppstadtUS (<http://www.doppstadtus.com/>)
- Eurohansa, Inc. (<http://www.eurohansa.com/applications.html>)
- Flottweg Separation Technology (<http://www.flottweg.de/>)
- Franklin Miller, Inc. (<http://www.franklinmiller.com/>)
- Granutech-Saturn Systems (<http://www.granutech.com/solid-waste-shredder.html>)
- Huber Technology (<http://www.huber.de/>)
- Integrated Engineers Inc. (<http://wecleanwater.com/>)
- Klein Technical Solutions GmbH (<http://www.klein-ts.com/en/>)
- Peninsula Equipment (<http://www.peninsulaequipment.com/Products.php>)
- SludgeSolution (<http://sludgesolutions.veoliaes.com/>)
- SSI Shredding Systems (www.ssiworld.com)
- UNTHA shredding technology (<http://www.untha.com/en>)
- Vandenbroek International (<http://www.vadeb.com/applications/msw-drying-rdf/>)

Storage, handling, and feeding systems

- Aumund Group (<http://www.aumund.com/>)
- Claudius Peters Technologies GmbH (<http://www.claudiuspeters.com/>)
- EUREMI S.A. (www.euremi.com)
- FCB. Ciment S.A. (<http://www.fcb-ciment.com>)
- FLSmidth A/S (<http://www.flsmidth.com/>)
- Fox Valve Development Corp. (<http://www.foxvalve.com>)
- Geo. Robson & Co (Conveyors) Ltd. (<http://www.robson.co.uk/>)
- Metso Minerals Industries Inc. (www.metsominerals.com)
- Pebco Inc. (<http://www.pebco.com/>)
- Pfister GmbH (<http://www.pfister.de/>)
- PILLARD FEUERUNGEN GmbH (<http://www.pillard.de/>)
- Polysius AG (<http://www.polysius.com/>)
- Schenck Process Group (<http://www.schenckprocess.com/en/>)
- STAG AG (<http://www.stag.net/>)
- Vecoplan LLC (<http://www.vecoplanllc.com/>)

- WTW Engineering (<http://www.mhc-engineering.de/116/>)

Co-firing of MSW and sewage sludge in the kiln

- Cadence Environmental Energy Inc. (<http://www.cadencerecycling.com/>)
- FCT-Combustion (<http://www.fctinternational.com/>)
- FLSmidth (<http://www.flsmidth.com/>)
- Greco-Enfil International S.L. (<http://www.grecoenfil.com/>)
- KHD Humboldt Wedag GmbH (<http://www.humboldt-wedag.de/>)
- PILLARD FEUERUNGEN GmbH (<http://www.pillard.de/>)
- Polysius AG (<http://www.polysius.com/>)
- Unitherm Cemcon Firingsystems GesmbH (<http://www.unitherm.co.at/>)

Emissions control systems

- Ecotech (<http://www.ecotech.com/>)
- Sick Group (<http://www.sick.com/>)
- K2BW (<http://www.k2bw.com/>)
- Altech Environment U.S.A. (<http://www.altechusa.com/>)