



# ERNEST ORLANDO LAWRENCE BERKELEY NATIONAL LABORATORY

---

Automated Continuous Commissioning of Commercial  
Buildings  
ESTCP Project SI-0929

Trevor Bailey, Zheng O'Neill, Madhusudana  
Shashanka, Philip Haves, Xiufeng Pang, Prajesh  
Bhattacharya

September 2011



## **DISCLAIMER**

This document was prepared as an account of work sponsored by the United States Government. While this document is believed to contain correct information, neither the United States Government nor any agency thereof, nor The Regents of the University of California, nor any of their employees, makes any warranty, express or implied, or assumes any legal responsibility for the accuracy, completeness, or usefulness of any information, apparatus, product, or process disclosed, or represents that its use would not infringe privately owned rights. Reference herein to any specific commercial product, process, or service by its trade name, trademark, manufacturer, or otherwise, does not necessarily constitute or imply its endorsement, recommendation, or favoring by the United States Government or any agency thereof, or The Regents of the University of California. The views and opinions of authors expressed herein do not necessarily state or reflect those of the United States Government or any agency thereof or The Regents of the University of California.

## Contents

List of Figures .....	4
List of Tables .....	8
Acronyms .....	10
ACKNOWLEDGEMENTS .....	12
EXECUTIVE SUMMARY .....	13
1.0 INTRODUCTION .....	18
1.1 BACKGROUND .....	18
1.2 GOAL AND OBJECTIVES OF THE DEMONSTRATION.....	20
1.3 REGULATORY DRIVERS.....	21
2.0 TECHNOLOGY DESCRIPTION .....	22
2.1 TECHNOLOGY OVERVIEW .....	22
2.2 TECHNOLOGY DEVELOPMENT .....	24
2.2.1 Building EnergyPlus Model.....	24
2.2.2 Building Visualization and Diagnostics.....	26
2.2.3 BCVTB implementation .....	36
2.3 ADVANTAGES AND LIMITATIONS OF THE TECHNOLOGY .....	43
3.0 PERFORMANCE OBJECTIVES.....	46
4.0 FACILITY/SITE DESCRIPTION .....	55
4.1 FACILITY/SITE LOCATION AND OPERATIONS .....	55
4.2 FACILITY/SITE CONDITIONS.....	57
5.0 TEST DESIGN .....	60
5.1 CONCEPTUAL TEST DESIGN .....	60
5.2 BASELINE CHARACTERIZATION .....	60
5.3 DESIGN AND LAYOUT OF TECHNOLOGY COMPONENTS.....	61
5.3.1 Instrumentation and Monitoring .....	61
5.3.2 Performance Monitoring System PC Server.....	70
5.4 OPERATIONAL TESTING .....	71
5.5 SAMPLING PROTOCOL .....	72
5.6 SAMPLING RESULTS .....	72
6.0 PERFORMANCE ASSESSMENT.....	76
6.1 Building EnergyPlus Model.....	78
6.2 Energy Diagnostics .....	82
6.3 Energy Savings Assessment .....	87
7.0 COST ASSESSMENT.....	100

7.1	COST MODEL .....	100
7.1.1	Hardware Capital Costs .....	100
7.1.2	Installation Cost .....	103
7.2	COST DRIVERS .....	103
7.3	COST ANALYSIS AND COMPARISON .....	103
8.0	IMPLEMENTATION ISSUES.....	107
9.0	REFERENCES .....	110
	APPENDICES .....	112
	Appendix A: Points of Contact.....	112
	Appendix B: Equipment Calibration and Data Quality Issues.....	113
	Appendix C: Detailed Energy Modeling –Drill Hall .....	115
	Appendix D: Detailed Energy Modeling –BLDG26 .....	124
	Appendix E: BLDG26 EnergyPlus Model Calibration and Verification.....	135
	Appendix F: Load Estimation.....	140
	Appendix F: Automated Continuous Commissioning Tool GUI Screenshots from the Demonstration .....	141
	Appendix H: Response to ESTCP IPR Action Items .....	145

## List of Figures

Figure 1 Automated Continuous Commissioning System.....	21
Figure 2 Diagram of the Performance Monitoring System. ....	22
Figure 3 Diagram of the Building Control Virtual Test Bed.....	24
Figure 4 Rendered geometry generated by DesignBuilder.....	25
Figure 5 Schematics for FDD module and visualization module.....	27
Figure 6 Univariate statistical monitoring .....	28
Figure 7 User Interface .....	30
Figure 8 Pull down menu.....	31
Figure 9 Energy usage visualization.....	31
Figure 10 Pull-down menu for different end use.....	32
Figure 11 Total power consumption comparisons between measurements and simulation predictions.....	32
Figure 12 Hot water energy consumptions between measurements and simulation predictions .	33
Figure 13 Visualizations for Air Handling Unit.....	34
Figure 14 Visualizations for the Chilled Water Subsystem.....	35
Figure 15 Visualizations for the Hot Water Subsystem.....	35
Figure 16 Drill-down and diagnostics interface.....	36
Figure 17 Results of running globalwi.....	37
Figure 18 BACnet configuration file .....	38
Figure 20 Specifying an the External Interface in the EnergyPlus IDF Editor .....	40
Figure 21 EnergyPlus setup interface for external real time weather information.....	40
Figure 22 Ptolemy interface to setup EnergyPlus.....	42
Figure 23 Actual water consumption in Drill Hall .....	53

Figure 24 Location of Building 7230.....	56
Figure 25 Location of Building 26.....	57
Figure 26 Location of additional power meters for Bldg 7230 .....	67
Figure 27 Locations for chilled water thermal energy and primary loop supply and return water temperature sensor for Bldg 7230.....	68
Figure 28 Location for hot water thermal energy meter for Bldg 7230.....	68
Figure 29 Locations of additional power meters/CTs for Bldg26 .....	69
Figure 30 Locations for chilled water BTU meter for Bldg26 .....	69
Figure 31 Locations for hot water BTU meter for Bldg26 .....	70
Figure 32 Drill Hall outside air temperature.....	73
Figure 33 Drill Hall AHU4 outside air temperature vs. mixed air temperature .....	73
Figure 34 Drill Hall secondary loop chilled water flow rate .....	74
Figure 35 Drill Hall chilled water supply temperature vs. chilled water return temperature. ....	74
Figure 36 Drill Hall AHU 4 static pressure .....	75
Figure 37 Sensitivity indices of facility electricity to 1009 input parameters .....	80
Figure 38 Calibration procedure .....	81
Figure 39 Comparisons of monthly electricity consumption.....	81
Figure 40 Comparisons of power consumption for chiller and AHU1 supply fan.....	82
Figure 41 Potential sensor bias diagnostics .....	83
Figure 42 Economizer fault .....	83
Figure 43 Lighting faults .....	84
Figure 44 Comparison of the total building electricity consumption between measured and simulated data for one week .....	84
Figure 45 Comparison of lighting power consumption (left) and cooling electricity power consumption (right) for one week.....	85

Figure 46 Comparison of cooling electricity power consumption for the period beginning 05-May-2011 and ending 07-May-2011 .....	85
Figure 47 Comparison of plug-loads for 01-Aug-2011 from 8:00 AM to midnight. ....	86
Figure 48 April plug load profiles in Building 26 .....	87
Figure 49 Total electricity consumption end use breakdown from May 4 to May 11, 2010.....	88
Figure 50 Drill Hall lighting demand from May 4 to May 11, 2010.....	89
Figure 51 Annual energy (electricity) end use breakdown comparisons between current operation and proposed operation (occupancy based lighting control) .....	90
Figure 52 Total electricity consumption monthly breakdown comparisons between current operation and proposed operation (occupancy based lighting control) .....	90
Figure 53 AHU2 operation temperatures with OA intake ratio (MAT-RAT/OAT-RAT) .....	91
Figure 54 AHU2 outside air (OA) damper position and outside air flow rate .....	92
Figure 55 Monthly comparison of cooling electricity consumption between current operation and proposed operation (reduce OA intake in non-economizer mode).....	93
Figure 56 Monthly comparison of steam consumption between current operation and proposed operation (reduce OA intake in non-economizer mode).....	93
Figure 57 AHU 1 & 2 operations.....	94
Figure 58 AHU1 schematic diagram .....	95
Figure 59 Annual energy (electricity) end use break-down comparisons between current operation and proposed operation (run two AHUs at the same time).....	95
Figure 60 Fan electricity consumption monthly breakdown comparisons between current operation and proposed operation (run two AHUs at the same time).....	96
Figure 61 Plug electricity consumption in Building 26 from March 3rd to June 3rd 2011 .....	97
Figure 62 Annual energy (electricity) end use breakdown comparisons between current operation and proposed operation (plug load regulation) .....	98

Figure 63 Total electricity consumption monthly break down comparisons between current operation and proposed operation (plug load regulation)..... 98

Figure 64 Pie chart plot of capital cost structure for Building 7230 and Building 26..... 104

Figure 65 Illustration of the scatter-plot utility that was eventually removed from the automated commissioning visualization tool. .... 109



## List of Tables

Table 1 Performance Objectives .....	46
Table 2 Summary of selected energy savings strategies and associated payback .....	54
Table 3 Major Equipment Used in Building 7230.....	58
Table 4 Major equipment used in Building 26 .....	58
Table 5 Additional system tool components for Bldg7230 .....	62
Table 6 Additional system tool components for Bldg26 .....	62
Table 7 Performance monitoring points list for Bldg 7230 .....	63
Table 8 Performance monitoring points list for Bldg26 .....	64
Table 9 Weather station measurement accuracy.....	70
Table 10 Building data facts .....	72
Table 11 Summary of performance assessment.....	76
Table 12 Consumption Outputs Chosen for the Sensitivity Analysis.....	79
Table 14 Real time (July 1 <sup>st</sup> to July 26 <sup>th</sup> , 2010) comparison of end use electricity consumption	82
Table 15 Total electricity consumption from May 4 to May 11, 2010.....	87
Table 16 Annual energy (electricity) end use break down comparisons between current operation and proposed operation (occupancy based lighting control) .....	89
Table 17 Annual energy (electricity and steam) end use break down comparisons between current operation and proposed operation (reduce OA intake in non-economizer mode).....	92
Table 18 Annual energy (electricity) end use break-down comparisons between current operation and proposed operation (run two AHUs at the same time).....	95
Table 19 Annual energy (electricity) end use break down comparisons between current operation and proposed operation (plug load regulation) .....	97
Table 20 Cost model for the automated continuous commissioning tool.....	100
Table 21 Material cost for Building 7230.....	101

Table 22 Material cost for Building 26.....	101
Table 23 Material cost for weather station .....	101
Table 24 Different capital cost scenarios for Building 7230 .....	105
Table 25 Different capital cost scenarios for Building 26 .....	105
Table 27 Cost analysis results for Building 7230 demonstration .....	105
Table 28 Cost analysis results for Building 26 demonstration .....	106

## **Acronyms**

AHU: Air Handling Unit

ANSI: American National Standards Institute

API: Application Programming Interface

ASHRAE: American Society of Heating, Refrigerating, and Air-Conditioning Engineers

BACnet: Building Automation and Control Networks

BMS: Building Management System

CFM: Cubic Feet per Minute

CHW: Chilled Water

CO<sub>2</sub>: Carbon Dioxide

CT: Current Transducer

DB: Database

DD: Data Diagnostic

DDC: Direct Digital Control

DEM: Digital Energy Monitor

DoD: Department of Defense

DoE: Department of Energy

EEMCS: Extended Energy Management and Control System

EIS: Energy Information Systems

EMCS: Energy Management and Control System

ESTCP: Environmental Security Technology Certification Program

FDD: Fault Detection and Diagnosis

GPM: Gallon per Minute

HVAC: Heating, Ventilation and Air Conditioning

HW: Hot Water

IBPSA: International Building Performance Simulation Association

ICC: International Code Council

IPMVP: International Performance and Measurement Verification Protocol

ISDN: Integrated Services Digital Network

LBNL: Lawrence Berkeley National Laboratory

MC: Monte Carlo

NAVFAC: Naval Facilities Engineering Command

NIST: National Institute of Standards and Technology

NOAA: National Oceanic and Atmospheric Administration

PACRAT: Performance and Continuous Re-Commissioning Analysis Tool

PC: Personal Computer

PI: Principal Investigator

POC: Point of Contact

RH: Relative Humidity

SIR: Savings to Investment Ratio

SQL: Structured Query Language

TMY: Typical Meteorological Year

U.S.: United States

UTRC: United Technologies Research Center

V: Volts

VAV: Variable Air Volume

VFD: Variable Frequency Drive

## **ACKNOWLEDGEMENTS**

This work was supported by the Assistant Secretary for Energy Efficiency and Renewable Energy, Building Technologies Program, of the U.S. Department of Energy under Contract No. DE-AC02-05CH11231.

This work was performed under the project EW09-29 administered by ESTCP (Environmental Security Technology Certification Program) technology program of the Department of Defense. We would also like to thank ESTCP program manager, Dr. James Galvin and facility manager at Naval Station Great Lakes, Mr. Peter Behrens, for their support.

## EXECUTIVE SUMMARY

The DoD (Department of Defense) is the largest single user of energy in the United States, representing 0.8% of the total US energy consumed and 78% of the energy consumed by the Federal government<sup>1</sup>. Approximately 70% of the DoD electricity use is consumed by its buildings and facilities. The energy policy for DoD is being guided by the Energy Policy Act of 2005, Executive Order 13423 [1], and the Energy Independence and Security Act of 2007 to ensure a 30% energy reduction by 2015. Increasing existing DoD facility energy efficiency offers the largest opportunity for reducing DoD energy consumption. Building energy systems often consume 20% more energy than is necessary due to system deviation from the design intent. Identifying the specific sources and root causes of energy waste in buildings can be challenging largely because energy flows are generally invisible and because of the diversity of potential problems. To help address this challenge, the United Technologies Research Center (UTRC) in partnership with the Lawrence Berkeley National Laboratory (LBNL) proposed to demonstrate an automated, model-based, whole-building performance monitoring system at two Department of Defense (DoD) sites in partnership with the Naval Station Great Lakes. The system continuously acquires performance measurements of HVAC and lighting usage from the existing Energy Management and Control System (EMCS) augmented by additional sensors as required (The system could also acquire water usage data, but this was not of interest at the selected demonstration sites.). The system compares these measurements in real time to reference simulation models that either represent the design intent for each building or have been calibrated to represent acceptable performance. The comparison enables identification and quantification of sub-optimal performance, identification of the conditions under which sub-optimal performance occurs, a means to compare alternative corrective actions using whole building metrics, and finally a means to validate improved performance once corrective actions have been taken. The study has also supported the development of best practice guides that outline procedures to ensure that a new facility's HVAC, lighting, and water distribution systems are operating properly and to correct faulty existing systems.

The goal of this project was to demonstrate a whole-building performance monitoring and anomaly classification system in two DoD buildings. The specific objectives of the project were to demonstrate a model-based whole-building monitoring system and establish its ability to:

- Identify, classify, and quantify building energy and water consumption deviations from design intent or an optimum,
- Support classification and identification of root causes of such deviation,
- Support recommendations for corrective actions,
- Quantify and prioritize the economic, energy, and water value for corrective actions, and
- Demonstrate that the building performance improves, ideally to its design intent, following implementation of corrective actions.

---

<sup>1</sup> DoD. 2008a. Office of the Under Secretary of Defense For Acquisition, Technology, and Logistics, Report of the Defense Science Board Task Force on DoD Energy Strategy, More Fight – Less Fuel.

The majority performance objectives were met during our demonstration. The exceptions include all the objectives related to water system. Based on the site visit and review with the facility manager at the Naval Station Great Lakes, water conservation is not viewed as a significant issue for buildings at Naval Station Great Lakes. The assessment of performance objective is summarized in the table below:

<b>Performance Objective</b>	<b>Success Criteria<sup>2</sup></b>	<b>Performance Assessment</b>
<b>Quantitative Performance Objectives</b>		
Reduce Building Energy Consumption (Energy) & Greenhouse Gas Emissions (CO <sub>2</sub> )	>10% reduction in building total energy consumption and related costs (over baseline) >15% reduction in building peak demand energy and related costs (over baseline) >10% reduction in building total equivalent CO <sub>2</sub> emissions (over baseline)	> 30% reduction in building total energy consumption and related costs (over baseline) >30% reduction in building peak demand energy and related costs (over baseline) >30% reduction in building total equivalent CO <sub>2</sub> emissions (over baseline)
Reduce HVAC Equipment Specific Energy Consumption (Energy)	>10% reduction in overall HVAC equipment specific energy consumption (over baseline)	> 20% reduction in overall HVAC equipment specific energy consumption (over baseline)
Reduce Building Loads (Energy)	5-10% reduction in lighting and plug loads and related costs (over baseline)	>20% reduction in lighting and plug loads and related costs (over baseline)
Building Model Validation	Overall building energy consumption accuracy within +/- 15% HVAC equipment energy consumption accuracy within +/- 10%	Overall building energy consumption accuracy within +/- 10% HVAC equipment energy consumption accuracy within +/- 10%
Automated Continuous Commissioning System Payback <sup>3</sup>	Simple payback time is less than 5 year <sup>4</sup>	SPB is between 2.65 and 6.43 SIR is between 1.13 and 2.75

<sup>2</sup> Success criteria related to building and HVAC equipment energy consumption will be assessed using both model-based simulations and actual energy measurements. Note: only those recommended energy fault corrective actions that were implemented by DOD facilities during the execution of this project could be assessed using actual energy measurements.

	SIR is greater than 2.1.	See the SPB, SIR calculation in section 7 for details
<b>Qualitative Performance Objectives</b>		
Ease of Use	An energy manager and/or facility team skilled in HVAC able to do automated commissioning of building with some training	The user interface was refined based on feedback from facility team. The refined interface was well received.
Energy Fault Identification, Classification and Prioritization	Energy manager and/or facility team able to detect , classify and prioritize (based on energy impact) building faults by comparing simulated building performance (design intent or optimal) against measured building performance	The system allows direct comparisons of energy consumption at multiple levels by providing deviations between the measurements and reference simulation models that either represent the design intent or have been calibrated to represent acceptable performance. Also, the system flags faulty behavior via anomaly scores. This information enables facility team to prioritize faults based on energy impacts from simulation models.
Water System Fault Identification, Classification and Prioritization	Energy manager and/or facility team able to detect , classify and prioritize building water system faults by comparing simulated building water consumption (design intent or optimal) against measured building water consumption	Water usage is not a primary concern to the demonstration sites.
Energy Fault Corrective Action Prioritization	Energy manager and/or facility team able to prioritize energy fault corrective actions by comparing the simulated building energy impact benefits for each fault corrective action alternative against the simulated or measured baseline building energy performance	By comparing the simulated building energy impact benefits, the system enables facility team to prioritize the fault corrective action.

<sup>3</sup> This payback success criterion is only applied to the case when the only retrofits considered are those that do not involve major equipment retrofits

<sup>4</sup> DoD Energy Managers Handbook <http://www.wbdg.org/ccb/DOD/DOD4/dodemhb.pdf>



Water System Fault Corrective Action Prioritization	Energy manager and/or facility team able to prioritize water consumption corrective actions by comparing the simulated building water consumption benefits for each fault corrective action alternative against the simulated or measured baseline building water consumption performance	Water usage is not a primary concern to the demonstration sites.
Automated Continuous Commissioning System Robustness	80% of faults identified are classified correctly (during 3 month demonstration period)	All faults that were detected and reported to the facility managers have been validated. Of the faults reported during the demonstration period, more than 80% have been identified and classified correctly based on feedback from the facility teams.

The following energy faults were detected and diagnosed from the demonstrated sites:

- Economizer faults: too much outside air intake during non-economizer modes
- Lighting faults: lights on during unoccupied hours
- Plug load faults: excessive plug load due to occupant behaviors.
- Chiller faults: chiller was off when commanded on due to control issues. These cause AHU discharge air temperature cannot be maintained as well as room temperatures. This causes thermal comfort issues.

The overall performance evaluation for the automated continuous commissioning system is summarized as following:

- A real-time model-based whole-building performance monitoring and energy diagnostics tool using EnergyPlus has been developed and demonstrated in Naval Station Great Lakes.
- A framework of whole-building simulation-based energy diagnostics has been established. Fault detection and diagnostics (FDD) algorithms based on statistical process control method such as  $T^2$  and Q statistics have been tested.
- A visualization dashboard for building performance energy monitoring and energy diagnostics has been developed and deployed in a real building. This dashboard provides an effective way for building facility manager to perform building performance decision-making.
- Currently, the instrumentation cost is relatively high. The largest components are the equipment and installation costs related to submetering and the on-site weather station. It is possible and reasonable to eliminate on-site weather station by using weather data from the internet or an existing weather station on the base. There are some ongoing research efforts for cost-effective submetering such as virtual meters.

- Facility team at the demonstration site found the energy usage visualization tool to be helpful as it enabled them to monitor impacts of control changes they made on energy consumption.
- Faults and issues identified by the automated continuous commissioning tool were appreciated by the facility team.

## 1.0 INTRODUCTION

### 1.1 BACKGROUND

Executive Order 13423 [1] and the Energy Independence and Security Act of 2007 (Title IV Subtitle C) require that U.S. federal agencies improve energy efficiency and reduce greenhouse gas emissions by 30% by 2015 relative to a 2003 baseline. It also requires water consumption to be reduced by 2% annually, beginning in 2008 and running through 2015, for a total reduction of 16% relative to a 2007 baseline. At some point in the future, similar goals for greenhouse gases may be formalized. Reducing the amount of energy and water wasted by building heating, ventilating, and air-conditioning (HVAC); lighting; and water systems can achieve much of this goal. These systems often consume 20% more energy than is necessary to meet occupant comfort and indoor air quality requirements largely due to system deviation from design intent [2]. HVAC systems present the most problems, particularly air distribution systems, and common correctional measures focus on modifications to control systems [3].

Identifying the specific sources and root causes of water and energy waste in particular buildings can be challenging, largely because energy flows and water usage are invisible and because of the diversity of potential problems. A crucial barrier is the lack of data or information at sufficient detail (due to lack of measurement systems or difficulty in acquiring such data) to isolate abnormal changes in load conditions or anomalous equipment operations. Moreover, even if problems are identified, it can be difficult to prioritize a set of corrective actions because it can require comparison of performance among diverse functional elements of a building. Similarly, establishing limits of performance (meaning a quantification of how much energy is being wasted relative to a physical optimum, constraint or design intent), and also identification of the factors limiting waste reduction is a challenge. For example, HVAC energy consumption can be reduced through cool-roof technology that reflects and emits near-infrared radiation but the maximum achievable savings are limited by physics and should be quantified to compare against alternative measures to reduce HVAC energy consumption. Also, once actions have been taken, it can be a challenge to validate that they have achieved the desired effect because conditions before and after the action may have changed.

To help address these challenges, the United Technologies Research Center (UTRC) in partnership with the Lawrence Berkeley National Laboratory (LBNL) proposed to demonstrate an automated, model-based, whole-building performance monitoring system at two Department of Defense (DoD) sites in partnership with the Navy. The system continuously acquires performance measurements of HVAC and lighting usage from the existing Energy Management and Control System (EMCS) augmented by additional sensors as required (The system could also acquire water usage data, but this was not of interest at the selected demonstration sites.). The system compares these measurements in real time to reference simulation models that either represent the design intent for each building or have been calibrated to represent acceptable performance. The comparison enables identification and quantification of sub-optimal performance, identification of the conditions under which sub-optimal performance occurs, a means to compare alternative corrective actions using whole building metrics, and finally a means to validate improved performance once corrective actions have been taken. The study has also supported the development of best practice guides that outline procedures to ensure that a new facility's HVAC, lighting, and water distribution systems are operating properly and to correct faulty existing systems. Such procedures have been developed already combining domain

expertise, measurements, and functional testing for variable air volume systems, package boilers, chillers, exhaust systems, and hydronic systems [4]. Finally, the system is based on open-source, publicly available software that can be run on personal computers.

Existing EMCSs provide for part but not all of this functionality. They are capable of acquiring, storing, and trending data collected from building systems assuming appropriate sensors are available. This ability can allow for detection of degradation over the long term and also identification of situations under which systems are operating in an unintended mode (e.g. the HVAC system is left “on” when the building is unoccupied). However, these systems cannot quantify losses in performance relative to the design intent. In particular, operational anomalies, such as simultaneous heating and cooling or improperly operated economizer cycles, cannot easily be detected without direct measurement of indoor and outdoor loads (which is not always feasible). Further, they cannot compute a limit of performance or optimum, meaning it is unclear how much wasted energy might be recovered, nor can they compare the impact of alternative corrective actions. Finally, EMCSs are typically based on proprietary hardware and software, whereas the system reported on here uses open source software.

The system features three innovations relative to existing EMCS technologies and methodologies. First, it employs an integrated, whole-building simulation model that provides subhourly calculations of HVAC, lighting, and water system energy consumption, taking into account the dynamic interactions among the building envelope, airflow, weather, internal loads, building usage, equipment, and controls. Detrimental interactions among these systems (particularly air distribution) can cause elevated energy consumption and identification and analysis of such problems are beyond the scope of both existing Fault Detection and Diagnosis (FDD) and EMCS technologies. Second, the system features optimal estimation of zonal heating and cooling loads. The internal sensible and latent heat gains, and external envelope loads are not easily measured directly, but are important in the analysis of abnormal behavior. Providing estimates of zonal loads will help operators and facility managers identify causes of excessive energy consumption and poor comfort and thereby help prioritize corrective actions. Third, the system makes use of data mining algorithms to automatically identify and quantify whole-building performance deviations and learn over time to differentiate acceptable versus unacceptable performance. The system offers two additional advantages: the simulation model enables isolation of whole-building performance deviation – not only identification of a pre-defined, rule-based set of equipment faults - and it provides a means to evaluate the energy and economic value of alternative corrective actions. Finally, the model can compute equivalent greenhouse gas emissions assuming source fuel type is known. A conference paper [5] describing the system has been prepared and will be presented in November, 2011.

Expected Benefits: The ultimate goal is to reduce energy consumption, peak electric demand, and water use in DoD buildings by providing actionable information to facility managers and building operators. Based on the energy savings achieved from two DoD demonstration sites (>30% energy consumption reduction in Building 7230 and > 20% reduction in Building 26 – see section 6 for the details), we expect to identify corrective actions that would reduce energy consumption by 15 to 20% per site but in an incremental manner consistent with the reductions required under both the Energy Independence and Security Act of 2007 and Executive Order 13423. With annual DoD expenditures of \$2.5B on facility energy consumption, the savings potential can be up to \$0.5B if the technology is applied across all DoD facilities. More conservatively, assuming the technology can be applied to only 10% of DoD facilities which are

known to have direct-digital-control (DDC) capabilities, deployment would result in \$50M of *annual* expenditure savings over the next three to five years. At the same time, the thermal comfort in DoD buildings would be improved to result in increased occupant productivity. Further, because the technology includes an energy model of each building, an additional benefit is to provide a means to quantify and prioritize alternative corrective actions, improving the long-term capital planning process.

## **1.2 GOAL AND OBJECTIVES OF THE DEMONSTRATION**

The goal of this project was to demonstrate a whole-building performance monitoring and anomaly classification system in two DoD buildings. It was originally planned that these buildings would be at two separate facilities; however, a number of logistical difficulties at the facilities considered initially led to implementation in two separate buildings at the same facility - Naval Station, Great Lakes, Illinois.

The specific objectives of the project were to demonstrate a whole-building monitoring system and establish its ability to:

- Identify, classify, and quantify building energy and water consumption deviations from design intent or an optimum,
- Support classification and identification of root causes of such deviation,
- Support recommendations for corrective actions,
- Quantify and prioritize the economic, energy, and water value (including computation of equivalent greenhouse gas emissions) for corrective actions, and
- Demonstrate that the building performance improves, ideally to its design intent, following implementation of corrective actions.

The project success criteria were

- The degree to which system level problems are identified and associated root causes are traceable to sub-system or component performance degradation,
- Quantification of the economic value of corrective actions, and
- The degree to which performance improves following corrective actions.

The software environment demonstrated in this project (Figure 1) integrates real-time building measurements and real-time weather data with a simulation model, data mining, and anomaly detection algorithms. The computer simulation "reference model" represents the design intent of the building and includes HVAC, lighting, internal process loads, and water consumption. The existing EMCS and supplemental instrumentation measures parameters such as on/off status, temperatures, relative humidity (RH), power, and water flows. Data mining and anomaly detection algorithms identify and classify deviation from design intent.

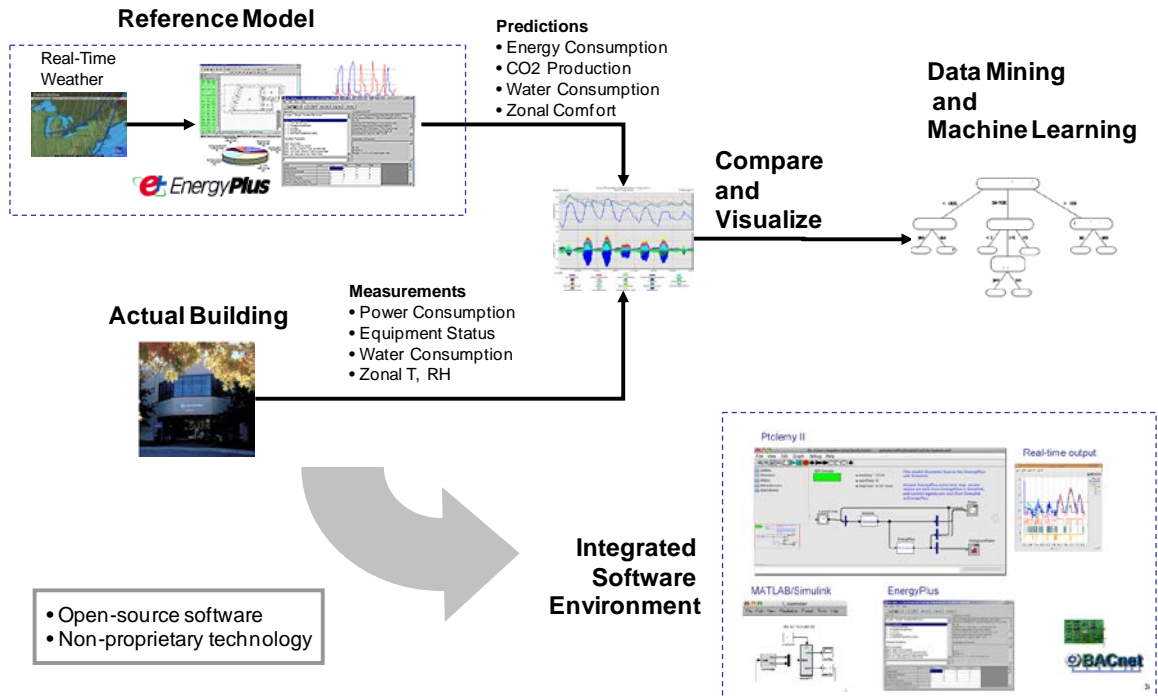

Figure 1 Automated Continuous Commissioning System

### 1.3 REGULATORY DRIVERS

Executive Order 13423 [1] and the Energy Independence and Security Act of 2007 (Title IV Subtitle C) require that U.S. federal agencies improve energy efficiency and reduce greenhouse gas emissions by 30% by 2015 relative to a 2003 baseline. It also requires water consumption to be reduced by 2% annually, beginning in 2008 and running through 2015, for a total reduction of 16% relative to a 2007 baseline.

## 2.0 TECHNOLOGY DESCRIPTION

### 2.1 TECHNOLOGY OVERVIEW

The implemented technology is a dynamic, model-based, whole-building performance monitoring system that compares measured performance metrics to those generated by a physics-based reference model representing “design intent” or expected performance. The system is depicted in Figure 2.

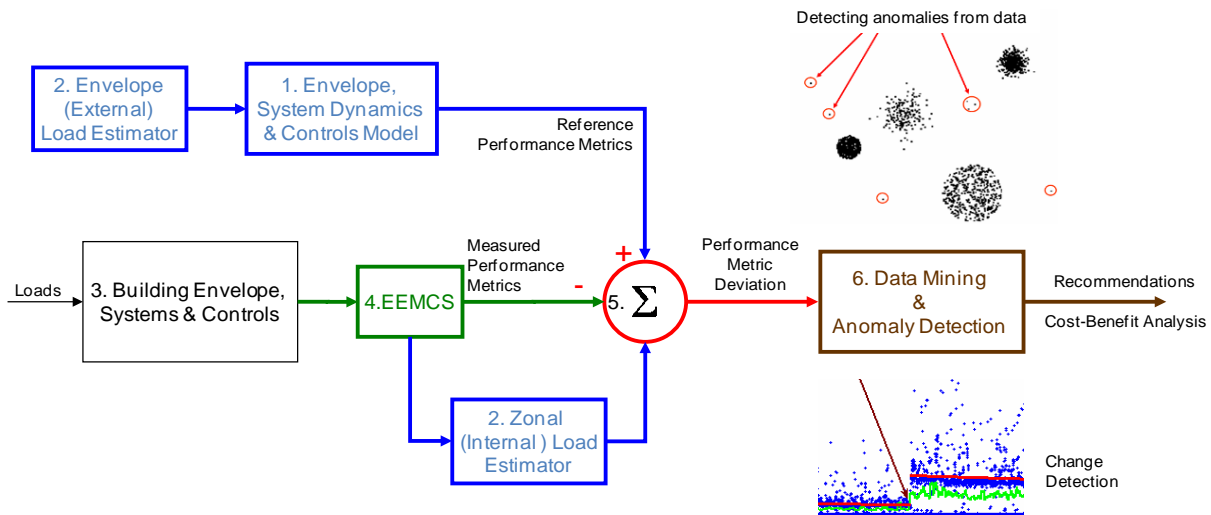

Figure 2 Diagram of the Performance Monitoring System.

The software system integrates and compares the output from an EnergyPlus building simulation model to measurements to detect deviations from design intent.

The key elements of the system are as follows:

1. **Building Reference Model.** A whole-building EnergyPlus simulation model representing the desired performance of the envelope, HVAC, lighting, water, and control systems. EnergyPlus [6] is an open-source whole-building simulation program developed by the Department of Energy. It models heating, cooling, lighting, and ventilating processes, as well as water usage in buildings and includes many innovative simulation capabilities such as time steps of less than one hour, modular systems, multizone airflow, thermal comfort, water use, and natural ventilation. The model can also represent “plug” loads including computers and calculates both the direct electrical energy consumption and the effects of heat gains on the HVAC system. The model takes as input a description of the building (e.g., geometry, materials, roof type, window type, shading geometry, location, orientation), its usage and internal heat loads, and the HVAC system description, and then computes the energy flows, zonal temperatures, airflows, and comfort levels at sub-hourly intervals for periods of days to years.
2. **Load Estimator.** Heating and Cooling Loads are defined as heat flow through the building envelope (external loads) or generation of heat at sources within the building zones (internal loads). External loads include the effects of weather (temperature, humidity, wind, solar radiation) and resulting envelope heat transfer including outside air infiltration. Internal loads

include the heat gains due to occupancy, plug loads (e.g., computers) and building usage (e.g., process loads). External loads must be either measured or estimated and applied as inputs to the Reference Model. Real-time weather measurements near each site are used for this purpose [7]. These estimates are compared to locally measured values of weather for validation purposes. Separately, zonal loads are estimated using available measurements and compared with the design intent represented by the Reference Model. The load estimator essentially is a complement to the Reference EnergyPlus model.

3. **Building Envelope and Systems.** This represents the physical building, the envelope, HVAC, lighting, and water systems – the physical plant.
4. **Extended Energy Management and Control System (EEMCS).** This consists of the building control system, together with the additional sensors required to determine key performance metrics. Additional sensors include electrical power submetering, fluid flow meters, and temperature sensors to determine thermal energy flow rates. Measurement of electrical input and thermal output enables the monitoring of chiller efficiency, for example. Installation of permanent instrumentation connected to the EMCS ensures that the benefits of the additional performance monitoring capability are available to base personnel over the long-term. For the Navy Atlantic Drill Hall, Building 7230, the existing Siemens APOGEE™ control system will be expanded to provide data acquisition for the additional sensors and to interface to a new personal computer (PC) that will provide a host for the simulation model and the data mining, anomaly detection, and data visualization software.
5. **Integrated Software Environment.** Represented by the  $\Sigma$  symbol in Figure 1, this is a software environment and supporting signal processing integrated with the EEMCS and Reference Model such that the Reference Model outputs can be automatically assimilated with and compared to measurements. This software system is built upon the Building Control Virtual Test Bed (BCVTB) [8], an open source software platform developed by LBNL for integration of EEMCS data and a range of energy modeling software tools including EnergyPlus. The BCVTB makes use of Ptolemy II [8], an open source software environment for combining heterogeneous modeling and simulation tools (developed at the University of California Berkeley). Ptolemy II is programmable, which enables comparisons of building data with building reference model outputs and also implementation of Data Mining algorithms. The system outputs information in the form of a data table and graphs as shown in Figure 1.
6. **Data Mining and Anomaly Detection.** Algorithms that take measured and reference data as input and process the data to classify operational patterns, detect outliers or changes, and identify faults. There are two main elements: Data Classification and Anomaly Detection. Data Classification and domain expertise has been used together to identify variables that describe the state of the system (a feature space) using methods such as cluster analysis. Anomaly detection addresses both sudden changes (e.g., a fault) and gradual trends (e.g., slowly developing water or air leaks). The system outputs alarms in the form of a text report, which are explained using graphs, as shown in Figure 3.



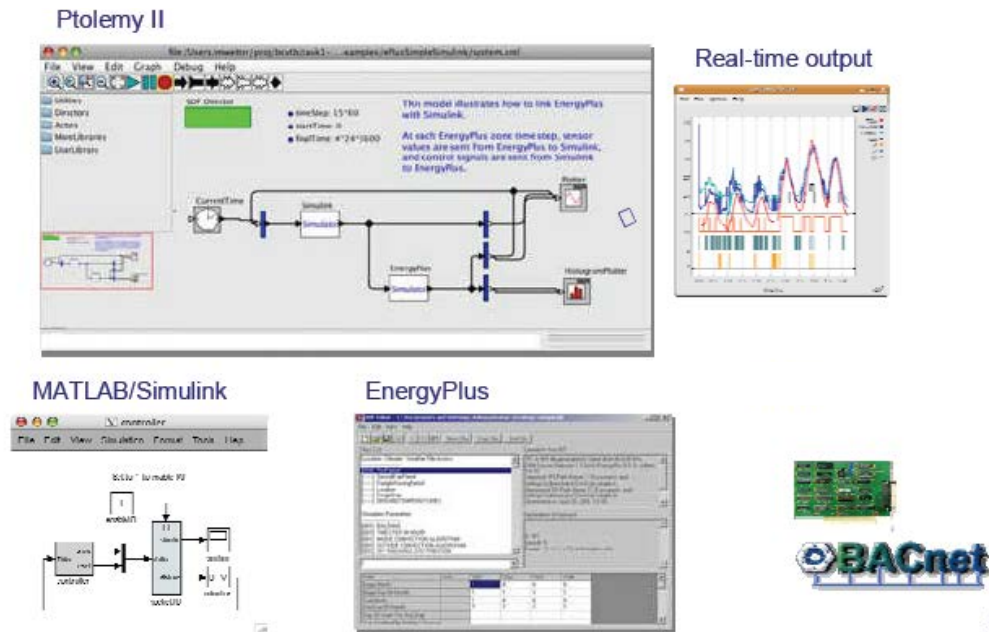

Figure 3 Diagram of the Building Control Virtual Test Bed.

The software system integrates EnergyPlus using the open-source software platform Ptolemy II. The system enables the integration with the EEMCS and also scripting and signal processing within the Ptolemy II environment.

The individual elements are combined into an integrated software environment using the BCVTB based on Ptolemy II. The whole system is capable of running on a PC.

## 2.2 TECHNOLOGY DEVELOPMENT

### 2.2.1 Building EnergyPlus Model

A whole-building EnergyPlus simulation model representing the performance of the envelope, HVAC, lighting, water, and control systems was developed in EnergyPlus [6] which is a whole-building simulation program developed by the United States Department of Energy. It models heating, cooling, lighting, and ventilating processes, as well as water usage in buildings, and includes many simulation capabilities such as time steps of less than one hour, modular systems, multizone airflow, thermal comfort, water use, and natural ventilation. An EnergyPlus model takes as input a description of the building (e.g., geometry, materials, roof type, window type, shading geometry, location, orientation), its usage profiles and internal heat loads (as a scheduled function of time), and the HVAC equipment and system description (e.g., chiller performance, air and water loop specifications), and then computes the energy flows, zonal temperatures, airflows, and comfort levels on sub-hourly intervals for periods of days to years.

The EnergyPlus geometry interface used for this analysis is DesignBuilder [10] which allows for a graphical display of all the three-dimensional geometry. After the geometry is entered into DesignBuilder, an IDF file (the EnergyPlus input file) with all geometry information is exported, and then the IDF Editor, distributed with EnergyPlus, is used to create the HVAC system model. The image in Figure 4 contains rendered geometry outline generated by DesignBuilder.

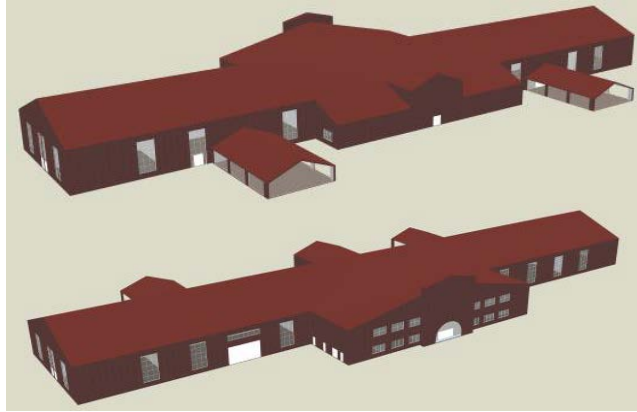

Figure 4 Rendered geometry generated by DesignBuilder

The EnergyPlus model used in this study is version 4.0 (build 4.0.0.024). The structure of the HVAC system in the EnergyPlus model is a series of modules connected by air and water fluid loops that are divided into a supply and a demand side. EnergyPlus assumes ideal controls for all the subsystems and components. Within the HVAC system capacity, the demand side is always balanced with the supply side.

In order to keep the size of the model and computation time manageable, zoning simplifications were made when entering the building geometry. All the rooms serving by the same VAV box were integrated into one thermal zone. The building model consists of 30 conditioned zones (12, 12, and 6 zones for the drill deck, first, and second floors respectively). Some zones represent a physical room in the building while other zones represent adjacent multiple rooms operating under similar energy usage/requirements. Each zone includes an "internal mass" that represents the thermal storage capacity of the room(s) (e.g., interior walls, furnishings, books, etc.).

### HVAC System Model

**HVAC Zone Setup.** In the drill deck and the classroom on the second floor, central system air from variable-air volume AHU is directly supplied to a zone without any zone level control. The EnergyPlus object- AirTerminal:SingleDuct:VAV:HeatAndCool:NoReheat is used to simulate this configuration.

**Building Water Distribution Loops.** Both the heating water and chilled water distribution loops in the building are modeled as variable flow systems including variable speed drives on the pumps (primary chilled water pump is constant speed pump). The primary and secondary chilled-water loop is modeled with a set-point temperature of 44°F (6.7°C). The heating-water loop is modeled with a set-point temperature of the function of outside air temperature. Pumps are modeled with premium efficiency motors. Pump power consumption is described by the following part load performance curve.  $C_1$ ,  $C_2$ ,  $C_3$ , and  $C_4$  are coefficients and PLR is the Part Load Ratio.

$$\text{FractionFullLoadPower} = C_1 + C_2\text{PLR} + C_3\text{PLR}^2 + C_4\text{PLR}^3$$

**Plant Energy Model.** Two 110-ton air cooled chillers (Carrier 30XAA6N-0-SM3) are used in the chiller plant. The chiller model is an empirical model. The model uses performance information at reference conditions along with three curve fits for cooling capacity and efficiency to determine chiller operation at off-reference conditions [11]. Chiller performance

curves are generated by fitting manufacturer's catalog data. Cooling is available from April 15th to October 15th. Whenever outside air temperature is greater than 58°F (14.4°C), the chiller is turned on. Whenever outside air temperature is less than 56°F (13.3°C), the chiller is off.

Details of the development of EnergyPlus model for the demonstration sites (Building 7230 and Building 26) can be found in Appendices C and D.

## **2.2.2 Building Visualization and Diagnostics**

### **Architecture and Data Management**

Fault Detection/Diagnosis (FDD) and Visualization are implemented as two separate modules. The Fault Detection/Diagnosis module runs in an automated fashion once every hour. In each instance, it reads the Building management system data and simulation model data for the past hour from the database, performs computations, and archives the results back in the database.

The visualization module is implemented as a stand-alone module and is initiated by the user. The user selects the time period that he/she wishes to explore after which the module reads corresponding data from the database and displays them to the user.

Schematics of both the modules are shown below.

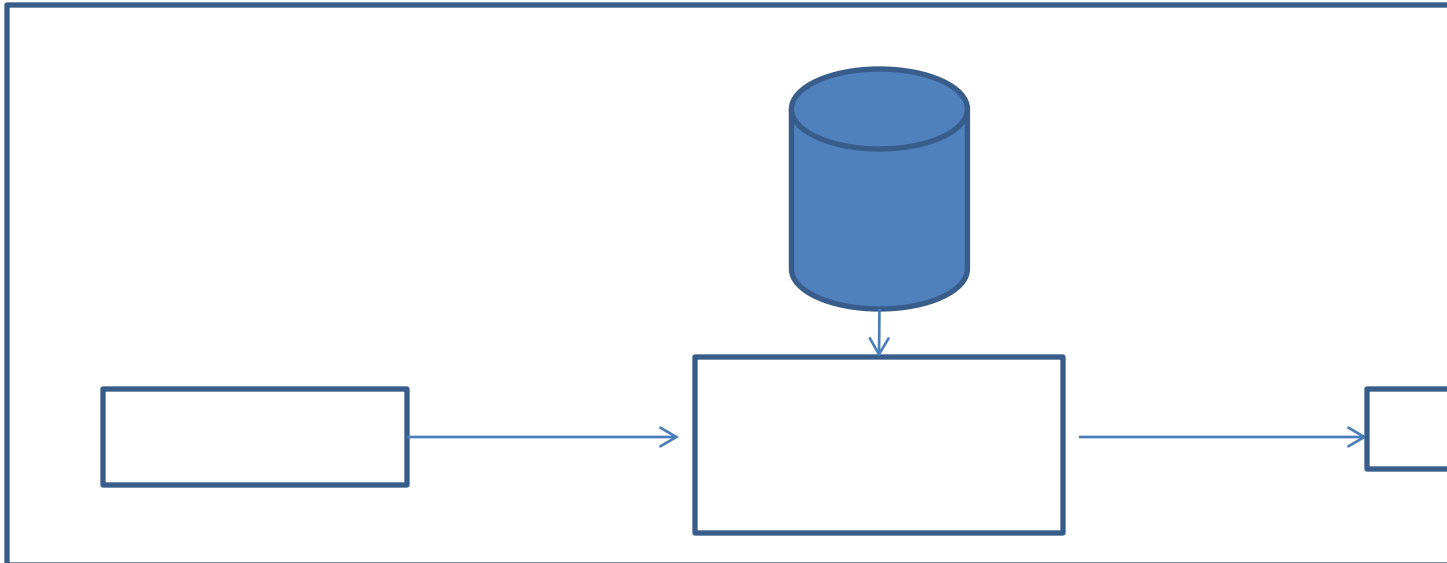
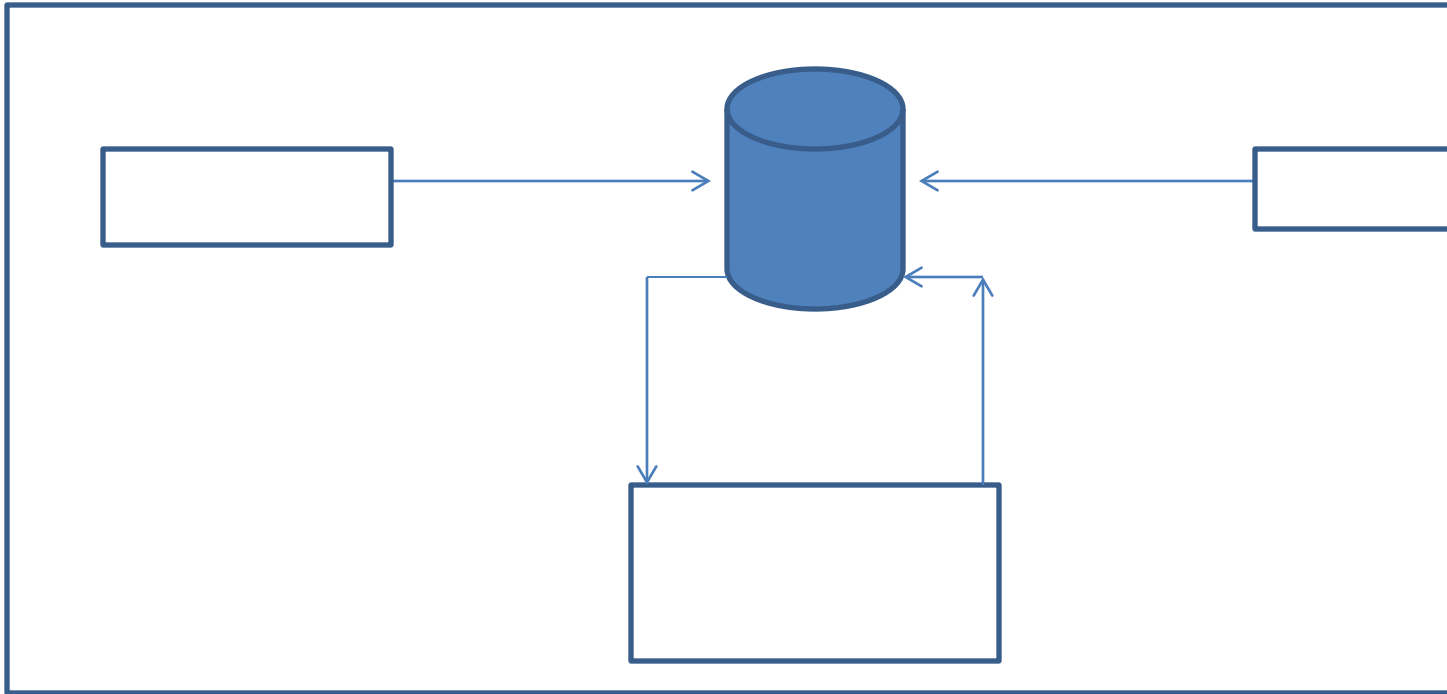

Figure 5 Schematics for FDD module and visualization module

***Interface between FDD/Visualization Module and the Database***

The FDD/visualization modules have been implemented in MATLAB [12] and interact with the database using special APIs that have been implemented in Java.

***Setup and Commissioning in a new building***

The following are the steps involved in commissioning the Fault Detection/Diagnosis and Visualization modules.

- 1) Begin archiving of BMS and EnergyPlus data.
- 2) Data are archived for a period of 30 days.
- 3) The initialization code for FDD computations is run (FDD\_computations\_init) at the completion of the 30 day period. This sets up all the necessary files for continuous running of the FDD module.
- 4) After the initialization is complete, the FDD visualization module is ready to be used.
- 5) The FDD computations module runs periodically, updating results every hour, using new incoming data.

### **FDD Approach**

The FDD module utilizes data from the BMS as well as input data and output results from EnergyPlus. The module primarily uses algorithms from the statistical process control literature to compute statistics pertaining to the deviations of the measured data from model predictions for the purpose of fault detection and fault identification.

The statistical methods used in the process monitor rely on the assumption that the characteristics of the data variations are relatively unchanged unless a fault occurs in the system. This implies that the mean and variance, at a particular operating point are repeatable, even though the individual values may show significant fluctuations. This repeatability allows thresholds for certain measures that indicate anomalous operation to be determined automatically. This is the essence of the underlying principle used in the FDD module.

### ***Principal Component Analysis (PCA)***

PCA is the most widely used data driven technique for monitoring industrial systems. It is an optimal dimensionality reduction technique for characterizing the variability of the data, and it accounts for correlations among variables. The lower dimensional representations of data produced by PCA can improve the performance of fault detection and diagnosis using multivariate statistics such as the Hotelling  $T^2$  statistic and the Q-statistic.

### ***T<sup>2</sup> and Q Statistic***

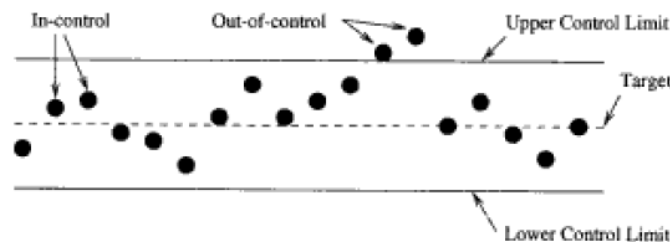

Figure 6 Univariate statistical monitoring

Figure 6 illustrates the typical approach to univariate statistical monitoring called the *Shewhart Chart*. Thresholds are determined for each observation variable where thresholds define boundaries of in-control operation. However, analyzing each observation individually will not capture correlations between variables. The multivariate  $T^2$  statistic is a generalization of the above technique to the multivariable case that takes this factor into account.

Let the training data with  $m$  variables and  $n$  observations for each variable be given by

$$X = \begin{bmatrix} x_{11} & x_{12} & \dots & x_{1m} \\ x_{21} & x_{22} & \dots & x_{2m} \\ \vdots & \vdots & \dots & \vdots \\ x_{n1} & x_{n2} & \dots & x_{nm} \end{bmatrix},$$

then the sample covariance matrix is given by

$$S = \frac{1}{n-1} X^T X.$$

An eigenvalue decomposition of the matrix S

$$S = V \Lambda V^T,$$

reveals the correlation structure of the covariance matrix. The projection  $\mathbf{y}$  of an observation vector  $\mathbf{x}$  onto the orthonormal matrix  $\mathbf{V}$  decouples the observation space into a set of uncorrelated variables corresponding to elements of  $\mathbf{y}$ . Assuming S is invertible, and using the definition

$$\mathbf{z} = \Lambda^{-1/2} V^T \mathbf{x},$$

the Hotelling T<sup>2</sup> Statistic is given by

$$T^2 = \mathbf{z}^T \mathbf{z}.$$

The T<sup>2</sup> statistic is a scaled squared 2-norm of an observation vector  $\mathbf{x}$  from its mean. The scaling on  $\mathbf{x}$  is in the direction of eigenvectors. Given a level of significance, appropriate threshold values for the T<sup>2</sup> Statistic can be determined automatically.

The Q-statistic is a similar measure and indicates the squared 2-norm of an observation vector from its mean in directions orthogonal to the eigenvectors retained from the PCA decomposition. In other words, it is a 2-norm of the residues. T<sup>2</sup> and Q statistics thus are complementary and together give a good indication of the statistical process going out of the normal operating range.

Along with the raw anomaly scores, we can also identify a list of variables (along with corresponding weights) that were either responsible for the fault and/or were most affected by the fault. Analysis of these variable contributions provides insight into probable causes of a detected change and/or fault.

### User Interface and Visualizations

Figure 7 shows a screenshot of the interactive user interface. The screen is divided into three panes – (a) loading data (shown in red box in figure below), (b) energy usage (shown in green box), and (c) anomalies (shown in blue box). Functionalities available in each of the panes are described in the following subsections.

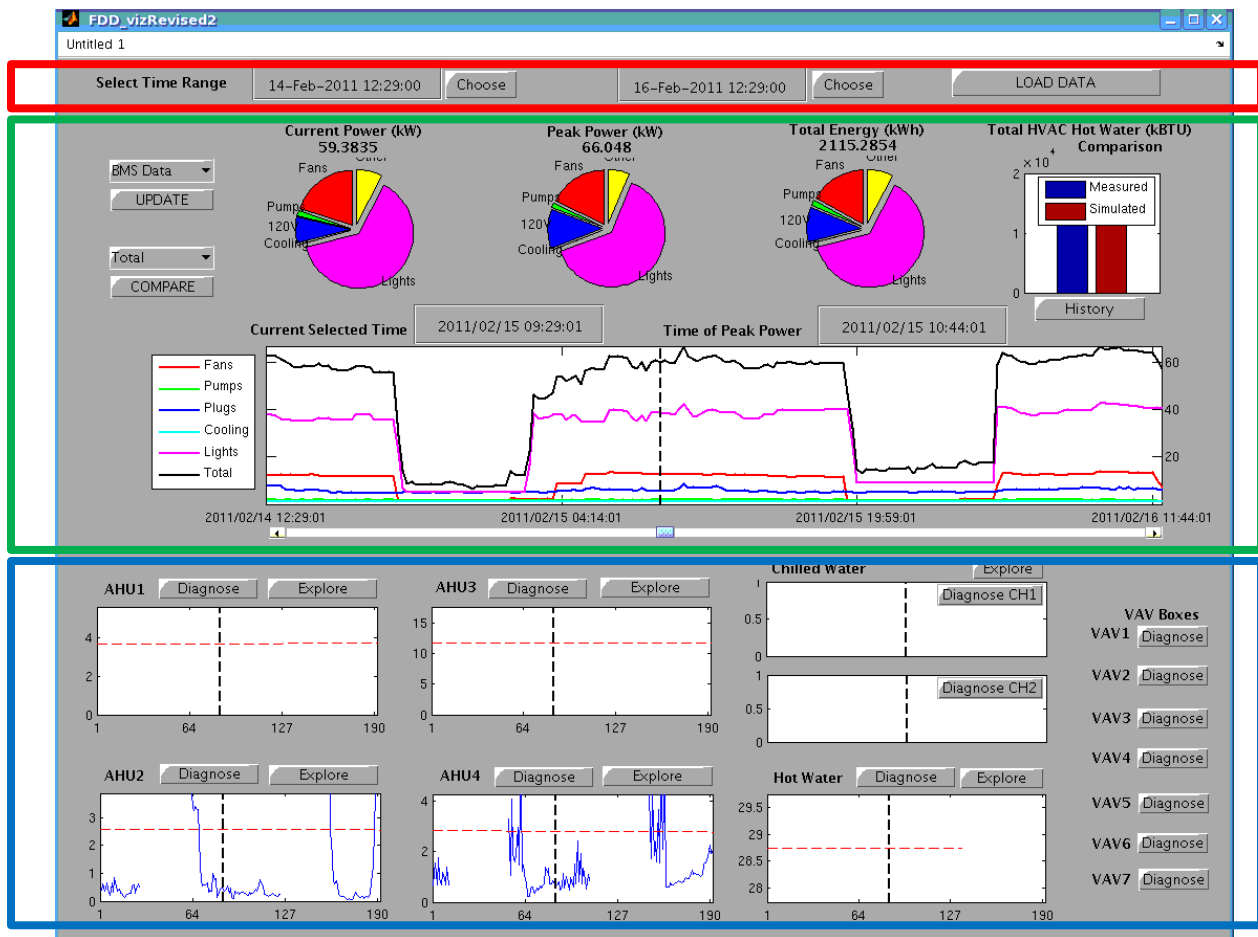

Figure 7 User Interface

## UI Functionalities

### *Time Range Selection and Data Loading*

The UI enables a user to select different time periods for exploration by selecting the start time and end time. Clicking on the “load data” button will load data for the corresponding time period.

### *Energy Usage and Performance Monitoring*

The top part of the user interface is saved for visualizing energy usage data. There are five visualizations that display various aspects of how energy usage is distributed across different end uses (lights, plug loads, cooling, fans etc.) in the selected time period.

- The first pie-chart displays the energy breakdown at any given time instant,
- The second pie-chart displays the energy breakdown at the time-step corresponding to peak overall power consumption during the selected time period,
- The third pie-chart displays the breakdown of the total energy usage over the selected time period,

- The line plot describes the power breakdown over the entire history of the selected time-period.
- The bar chart displays total energy consumed on the HVAC Hot Water side in kBTU for the selected time period.

A slider functionality is included where the slider moves over the entire range of the selected time period. Dragging the slider to a particular time point results in the display of current energy consumption pie-chart corresponding to that time-point and places a marker at the appropriate time-position in the line-plot as shown in Figure 3.

There are two kinds of data that can be explored –

- data from BMS, and
- data from the simulation model.

There is a pull-down menu from which user can select either the BMS data or the model data to visualize.

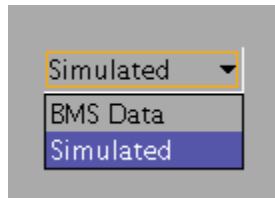

Figure 8 Pull down menu

Selecting the data source and clicking the update button will update all the four graphs in the energy usage pane.

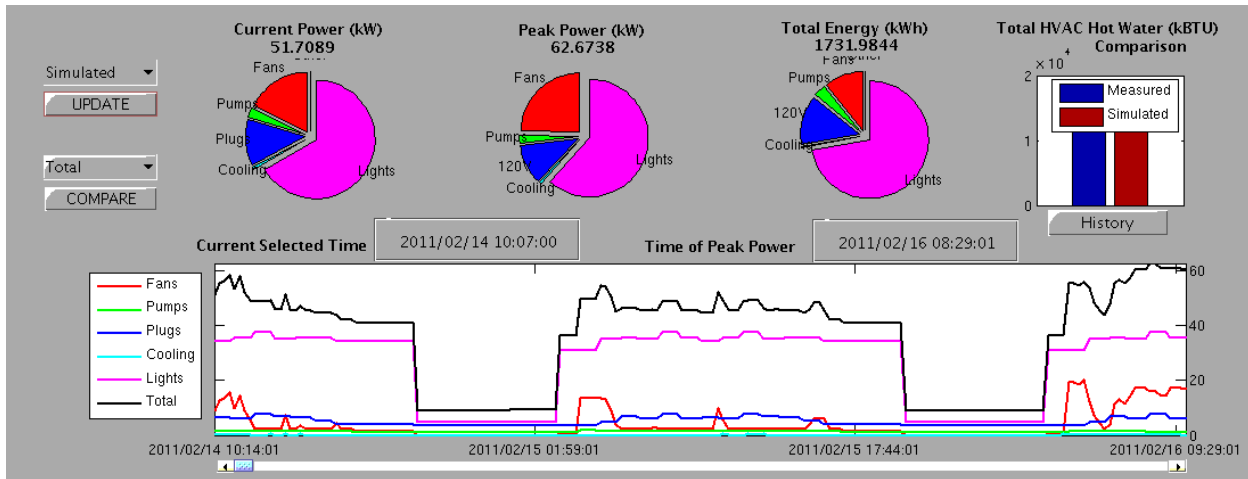

Figure 9 Energy usage visualization

### Data Comparison

There is a pull-down menu from which user can select an end use (lights, plug loads, cooling, fans, total) and obtain a visual comparison between the predicted data and measured data from BMS. This is shown in the figure below.



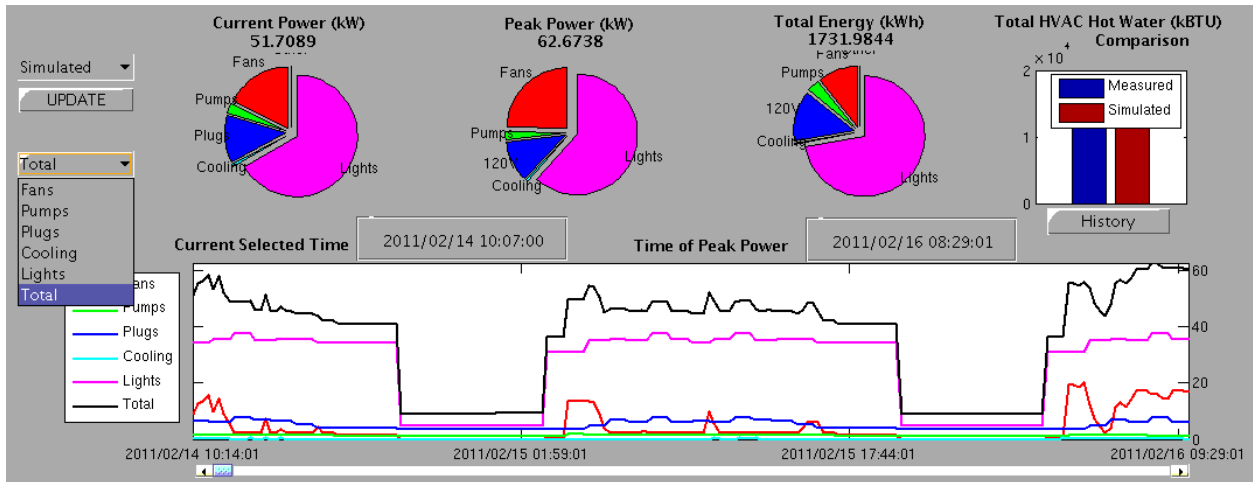

Figure 10 Pull-down menu for different end use

Once the selection is made and the user hits the “compare button,” a new plot opens up that displays the comparison for the selected attribute, as shown in Figure 11.

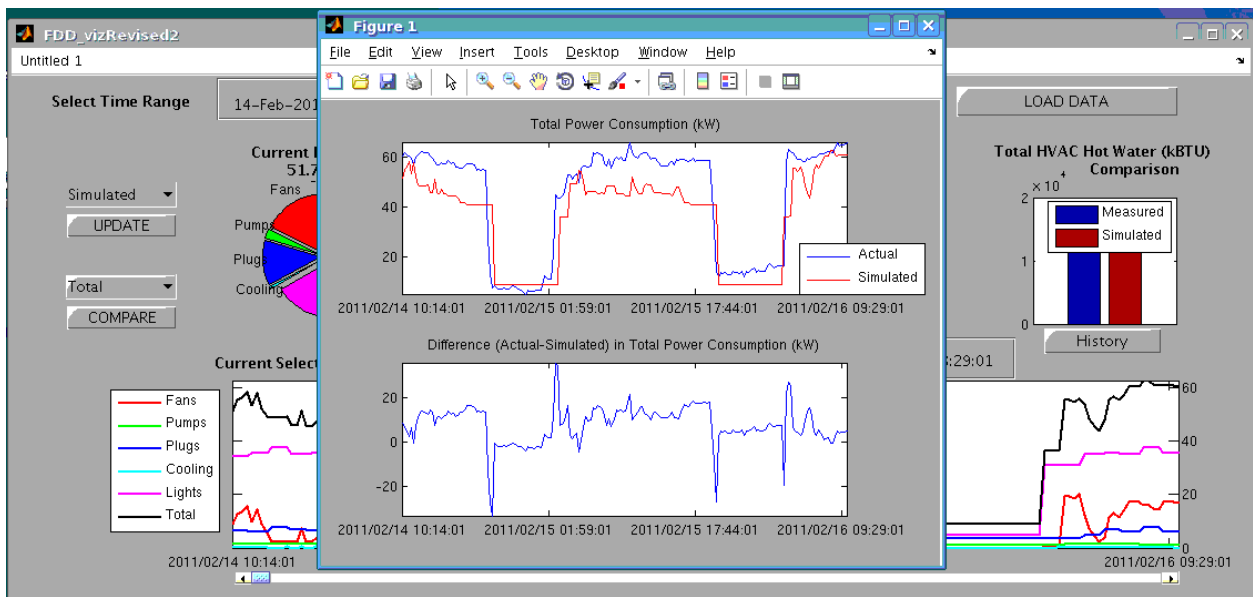

Figure 11 Total power consumption comparisons between measurements and simulation predictions

### Hot Water

The hot water energy consumption can also be visualized by clicking the “history” button under the Hot Water bar graph.

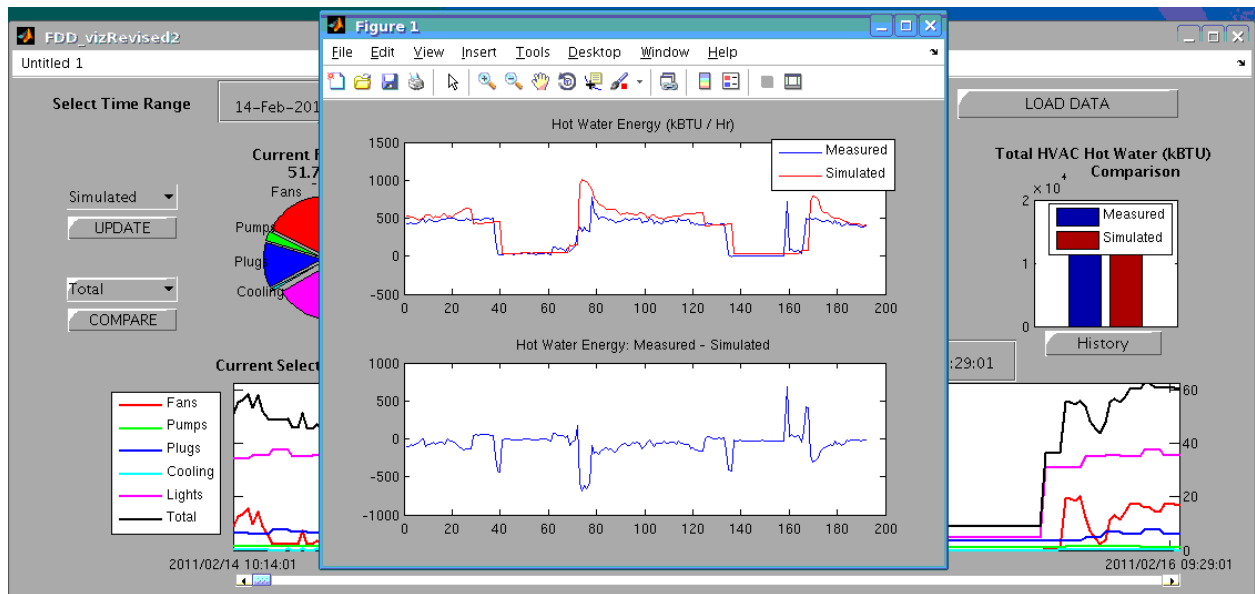

Figure 12 Hot water energy consumptions between measurements and simulation predictions

Visualization of chilled water consumption currently is not included in the user interface. However, the chiller electricity consumption is visible via the user interface.

### ***Anomaly Scores and Subsystem Drilldown***

The bottom part of the user interface is dedicated to Anomaly Scores and monitoring the health of each subsystem (Chilled Water System, Hot Water System, Air Handling Units and Variable Air Volume Boxes).

Each subsystem (AHU, Chillers, and the Hot Water System) has a graph associated with it indicating the anomaly score (in blue) corresponding to the system health. Also shown in red is a threshold calculated mathematically. If the anomaly score exceeds the threshold at any instant in time, it indicates an anomalous event. The anomaly score is computed only when the system is in operation and no anomaly score is displayed when the system is not running.

The UI allows the user to view additional visualizations of the data to help understand the cause of an anomaly and these can be accessed by buttons marked “Diagnose” and “Explore.”

### ***Detailed Exploration of Subsystem Behavior***

Figure 13 illustrates the visualizations for an Air-Handling Unit. There are separate plots for temperature control, economizer operation, heating coil operation and cooling coil operation. In the scatter plot for economizer operation, darker points represent more recent data.

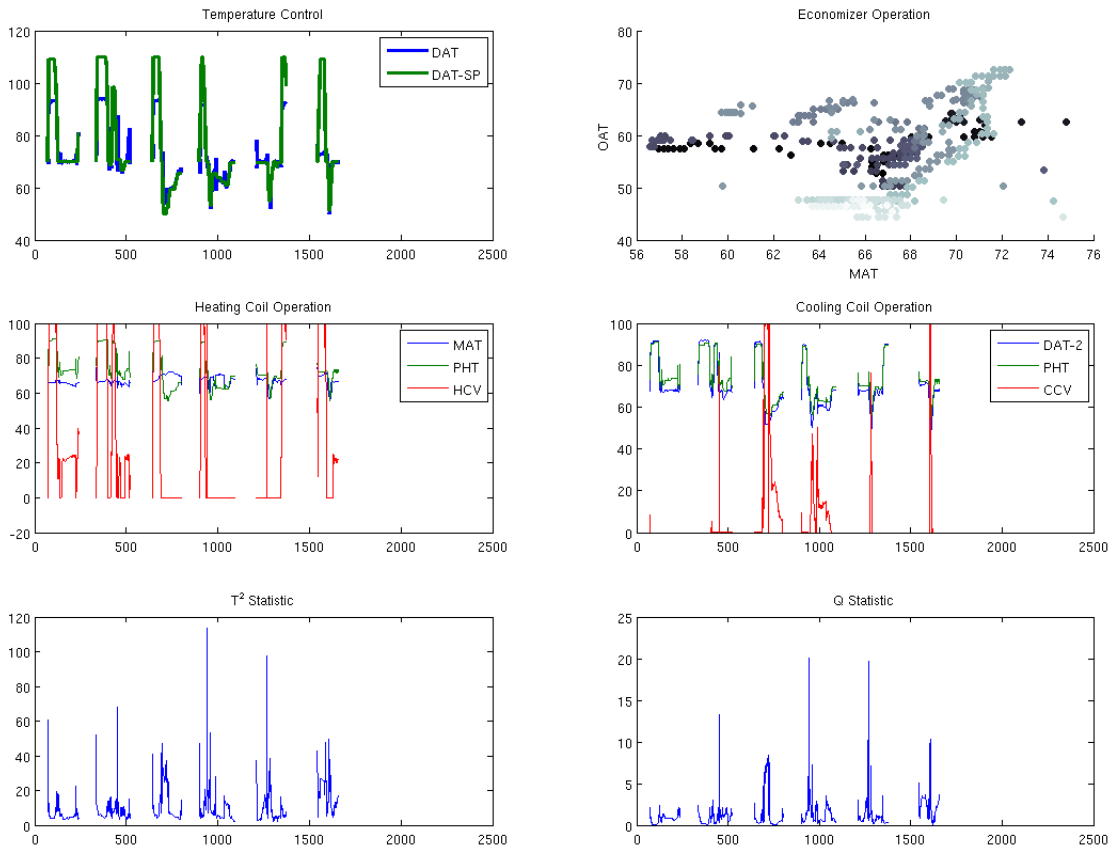

Figure 13 Visualizations for Air Handling Unit

Figure 14 illustrates the visualizations used for chilled water subsystem and Figure 15 shows the same for the hot water subsystem.

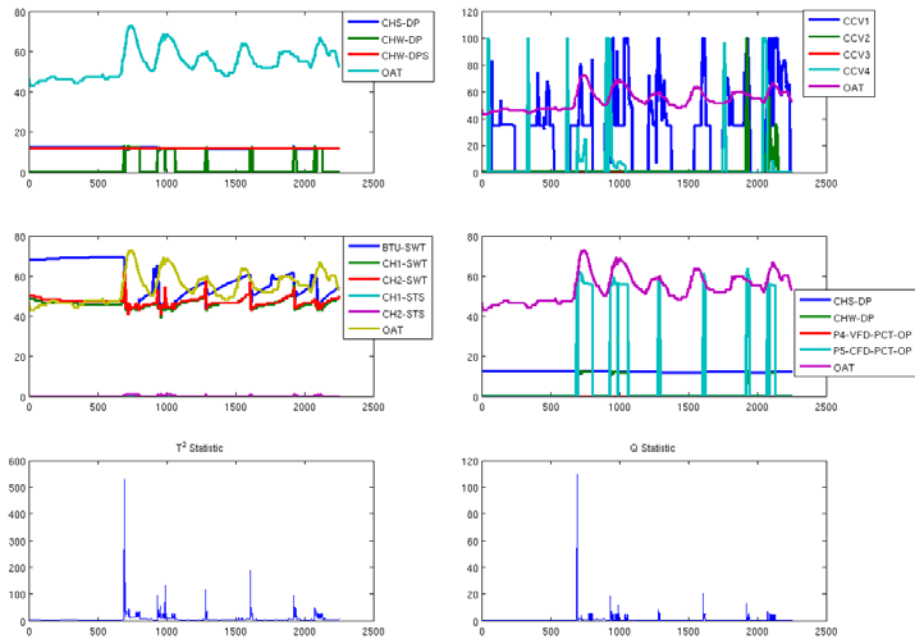

Figure 14 Visualizations for the Chilled Water Subsystem

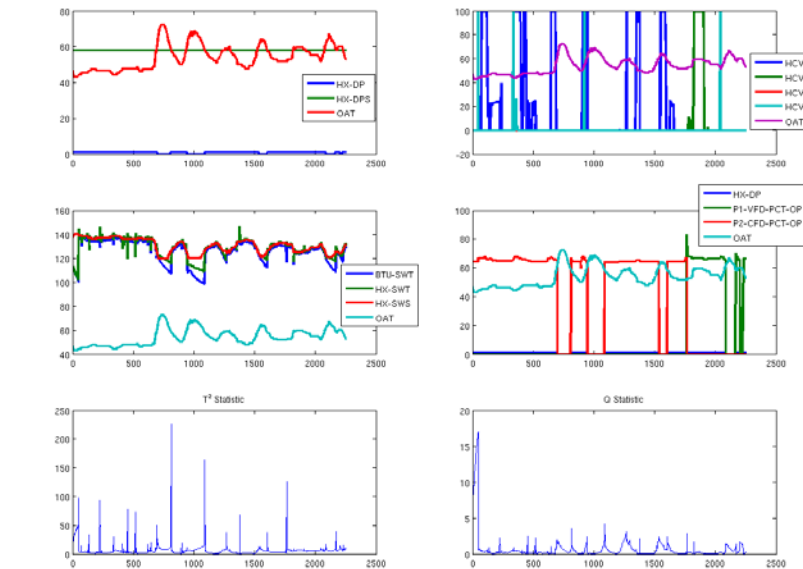

Figure 15 Visualizations for the Hot Water Subsystem

### ***Diagnosis of Detailed Subsystem Behavior***

The figure below shows a snapshot of the user interface available to drill-down and diagnose the cause of an anomaly.

The UI displays the anomaly score and the threshold and, in addition, also plots the “contributions” of the individual variables that were used in computing the anomaly score. This gives the user an idea of the significance of different variables in causing an anomaly. A slider allows the user to explore the contributions of the different variables at a selected instant in time to understand.

The UI also allows the user to select any of the variables via a pull-down menu and view the time-history of the BMS data for that sensor, the corresponding model predictions and the difference between the measured data and model predictions.

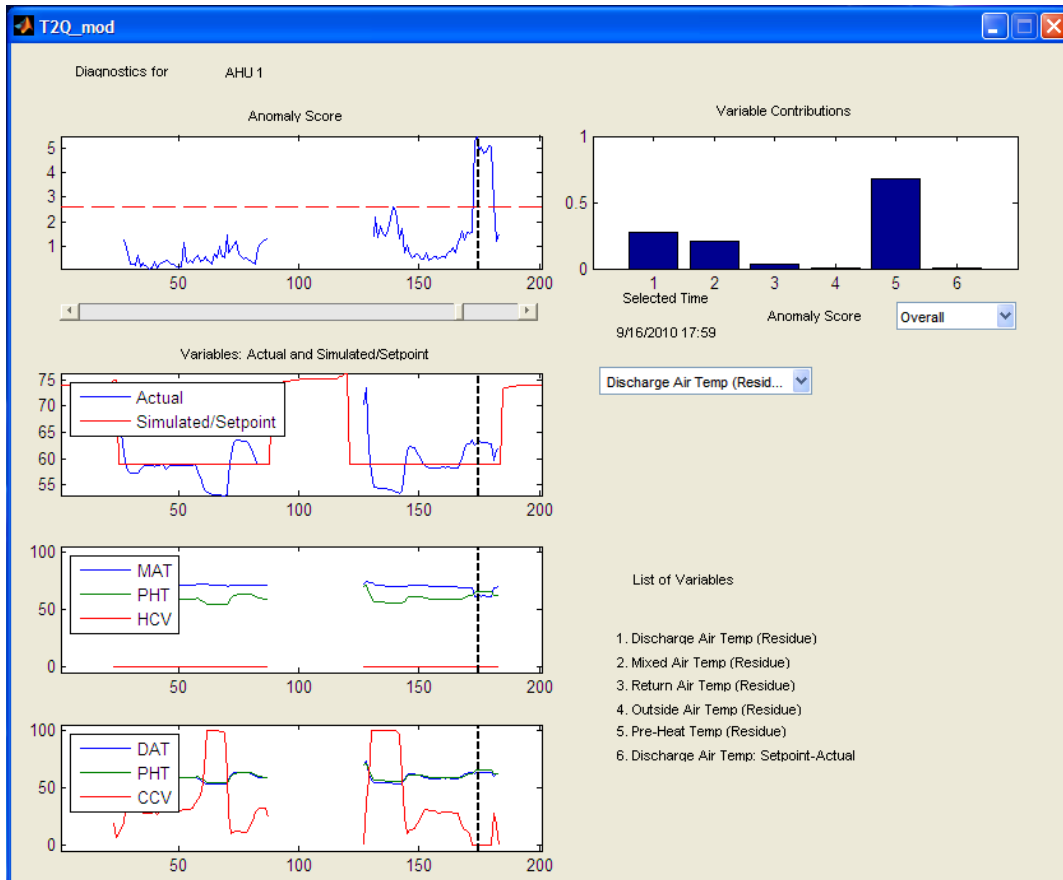

Figure 16 Drill-down and diagnostics interface

### 2.2.3 BCVTB implementation

The use of the Building Controls Virtual Test Bed (BCVTB) to enable real-time building energy simulation using EnergyPlus is described in [13]. This subsection describes the step-by-step procedure for implementing and configuring the BCVTB.

#### BACnet interface

The BACnet module in the BCVTB, described in [14], interfaces with the Siemens BACnet server in order to collect the building performance data. The procedure for using the BACnet interface involves the following steps:

- 1) Collect the BACnet server/device information from the vendor, including device instance, object type and mapping of all the data points to relevant object type instances. The device instance can be verified by running globalwi in the BACnet-stack/bin-linux directory, as illustrated in Figure 17. As can be seen from Figure 17, there are five devices (Siemens MEC controllers), with instance numbers 7150 to 7154, in the Siemens EMS.

```
[xpang@estcp-sitel bin-linux]$ ls
bacrp bacwp globalwi readobjlist
[xpang@estcp-sitel bin-linux]$ ./globalwi
Received I-Am Request from 7154, MAC = 172.16.10.10.186.192
Received I-Am Request from 7153, MAC = 172.16.10.10.186.192
Received I-Am Request from 7152, MAC = 172.16.10.10.186.192
Received I-Am Request from 7151, MAC = 172.16.10.10.186.192
Received I-Am Request from 7150, MAC = 172.16.10.10.186.192
7154
7153
7152
7151
7150
[xpang@estcp-sitel bin-linux]$ █
```

Figure 17 Results of running globalwi

- 2) Develop an xml configuration file. Three types of object need to be specified in the xml configuration file:
  - BACnet. This is the root of the xml configuration file, every file has to start with <BACnet> and end witht <BACnet>. Only contents specified between these delimiters will be recognized by BACnetreader.
  - ObjectType. This is used to specify BACnet objects, including device objects and non-device objects. None-device objects are attached to a device object, therefore, none-device objects are specified at the child level of device objects, although they use the same name “ObjectType”. For device objects, the name attribute should be “DeviceObjectType”, the instance attribute should be the device instance number. For non-device objects, the name attribute should be the name of the object. For example, for “AnalogInputObjectType”, the instance attribute should be the object instance number.
  - PropertyIdentifier. This is used to specify the BACnet properties that the user wants to query from the BACnet server/device. They can be properties of both a device object and a non-device object. They should be at the child level of corresponding objects. The name attribute should be the name of the property.

Figure 18 shows the configuration file used in the Great Lakes installation (Building7230).

```
<?xml version="1.0" encoding="utf-8"?>
<BACnet xmlns="http://www.w3.org/2001/XMLSchema" xmlns:xsi="http://www.w3.org/2001/
XMLSchema-instance">
  <ObjectType name="DeviceObjectType" instance="7150">
    <ObjectType name="AnalogValueObjectType" instance="1">
      <PropertyIdentifier name="Present_Value"/>
    </ObjectType>
    <ObjectType name="AnalogValueObjectType" instance="2">
      <PropertyIdentifier name="Present_Value"/>
    </ObjectType>
    <ObjectType name="AnalogValueObjectType" instance="3">
      <PropertyIdentifier name="Present_Value"/>
    </ObjectType>
    <ObjectType name="AnalogValueObjectType" instance="4">
      <PropertyIdentifier name="Present_Value"/>
    </ObjectType>
    <ObjectType name="AnalogValueObjectType" instance="5">
      <PropertyIdentifier name="Present_Value"/>
    </ObjectType>
    <ObjectType name="AnalogValueObjectType" instance="6">
      <PropertyIdentifier name="Present_Value"/>
    </ObjectType>
    <ObjectType name="AnalogValueObjectType" instance="7">
      <PropertyIdentifier name="Present_Value"/>
    </ObjectType>
    <ObjectType name="AnalogValueObjectType" instance="8">
      <PropertyIdentifier name="Present_Value"/>
    </ObjectType>
  </DeviceObjectType>
</BACnet>
```

Figure 18 BACnet configuration file

- 3) Develop a Ptolemy model. An example model is shown in Figure 19. By double clicking the BACnet module, a configuration window will pop up. The xml file configured in step 2 needs to be specified here. The sampling interval can be specified by double clicking the SDF director.

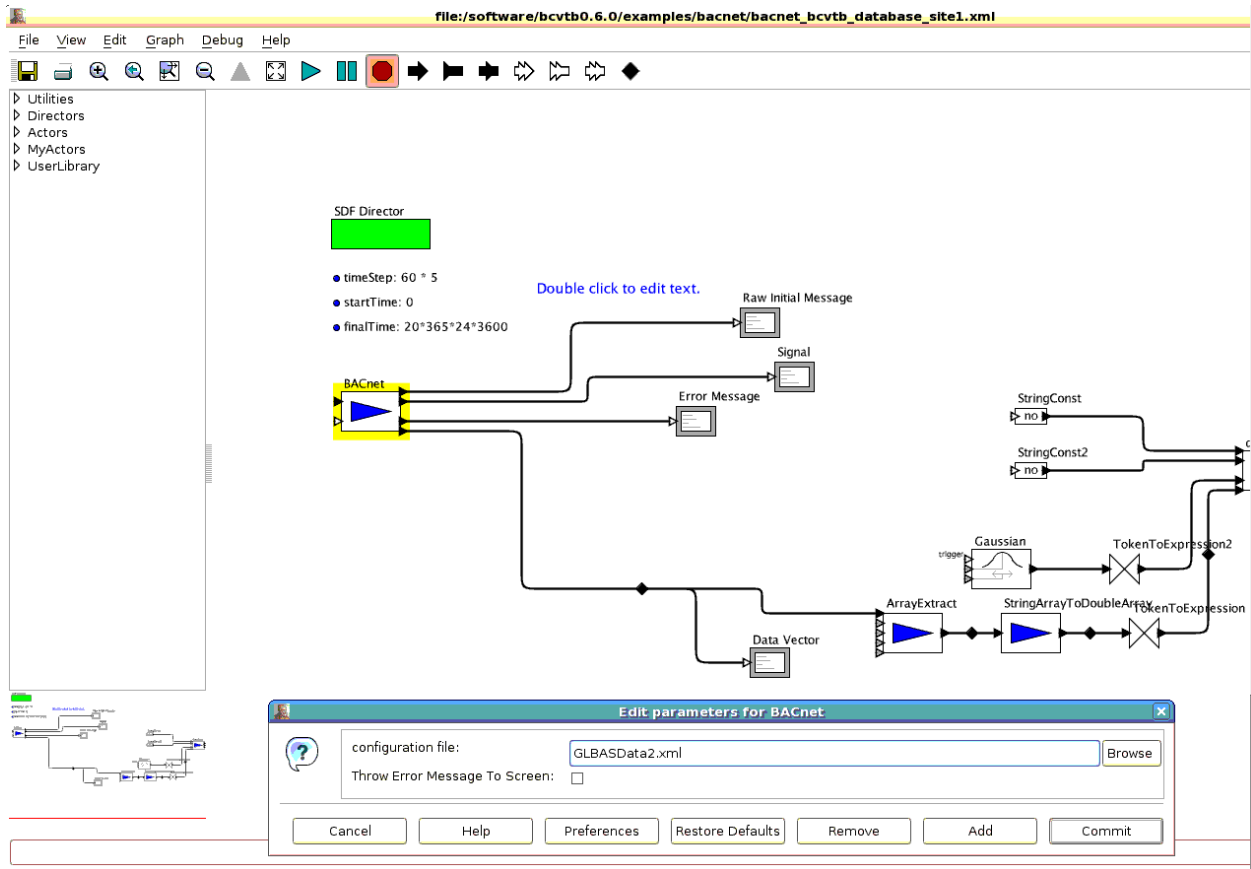

Figure 19 BACnet model presented in the Ptolemy II UI

### Database integration

The database integration involves the following steps:

- 1) Create the required tables in the database with the appropriate columns. In this project, a separate table was used for measured data, EnergyPlus model output data, Anomaly score data, Anomaly Limit data and Anomaly Contribution data.
- 2) Set up the Database Connector Tool. Create a home directory for the Database Connector Tool, say DCT\_HOME. All binary files and script files reside in DCT\_HOME/bin and all the supporting configuration files reside in DCT\_HOME/etc directory.
- 3) Create shell scripts (for Linux) or batch files (for Windows). The java-based Database connector tool is essentially a wrapper program around the database API. It facilitates easy interaction with the database (both reading and writing). The Database connector tool accepts several inputs in order to provide flexibility. One needs to build script files to wrap this tool with some fixed inputs, so that the script can then be easily used for specific purposes, such as sending data from BCVTB (for both BACnet and EnergyPlus) to the database, or importing data from the database into a comma separated file.
- 4) Integrate with the BCVTB. The script file of the Database Connector Tool is executed using a system call from the System Call actor inside BCVTB. In case of sending data to the database, this System Call actor takes the data as a single string of comma separated values, as one of the inputs.

### Real time EnergyPlus in the BCVTB



In EnergyPlus, the External Interface objects are used to exchange data between EnergyPlus and the BCVTB. The objects can map to three EnergyPlus input objects called ExternalInterface:Schedule, ExternalInterface:Actuator and ExternalInterface:Variable. The ExternalInterface:Actuator was used to implement real-time EnergyPlus at Great Lakes. This object behaves identically to EnergyManagementSystem:Actuator, with the following exceptions:

0. Its value is assigned by the external interface.
1. Its value is fixed during the zone time step because this is the synchronization time step for the external interface.

Configuring the data exchange involves the following three steps:

### Create an EnergyPlus idf file

Figure 20 shows how to set up the part of an EnergyPlus input file that specifies the name of the External Interface using IDF Editor.

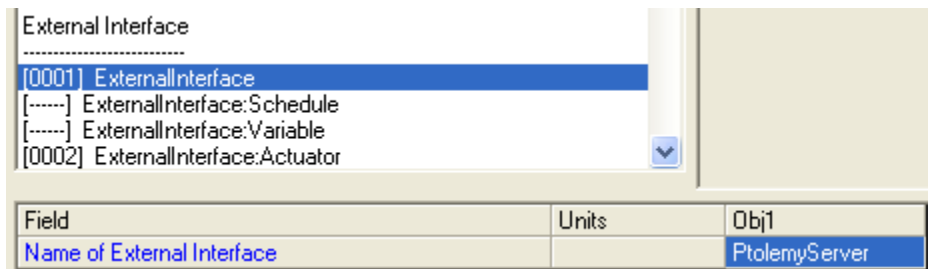

Figure 20 Specifying an the External Interface in the EnergyPlus IDF Editor

Figure 21 shows how to declare actuators that update the outdoor dry bulb and relative humidity values in EnergyPlus. It is worth noting that actuators to update the weather data are only available in EnergyPlus Version 6 and later.

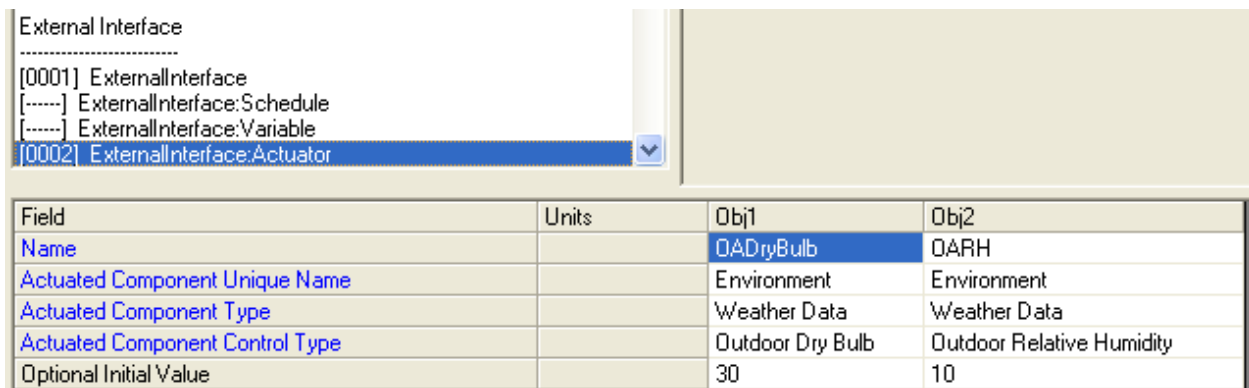

Figure 21 EnergyPlus setup interface for external real time weather information

If the optional field that specifies the initial value is unspecified, then the actuator will only be used during the real time operation, but not during the warm-up and the system sizing. Since actuators always overwrite other objects (such as schedules), all these objects have values that are defined during warm-up and system sizing, even if no initial value is specified in the ExternalInterface:Actuator.

### **Create an xml file**

It is necessary to specify the order of the elements in the signal vector that is exchanged between EnergyPlus and the BCVTB. This information is specified in the file variables.cfg. The file variables.cfg needs to be in the same directory as the EnergyPlus idf file. The file has the following form:

```
<?xml version="1.0" encoding="ISO-8859-1"?>
<!DOCTYPE BCVTB-variables SYSTEM "variables.dtd">
<BCVTB-variables>
  <variable source="EnergyPlus">
    <EnergyPlus name="Space 1-1" type="Zone/Sys Sensible Cooling Rate"/>
  </variable>
  <variable source="EnergyPlus">
    <EnergyPlus name="Space 2-1" type="Zone/Sys Sensible Cooling Rate"/>
  </variable>
  <variable source="Ptolemy">
    <EnergyPlus actuator="OADryBulb" />
  </variable>
  <variable source="Ptolemy">
    <EnergyPlus actuator="OARH" />
  </variable>
</BCVTB-variables>
```

The <variable source="Ptolemy"> entry specifies the element written from the BCVTB to EnergyPlus. The <variable source="EnergyPlus"> entry specifies the element computed by EnergyPlus and sent to the BCVTB.

### **Create a Ptolemy model**

A Ptolemy model is needed to start EnergyPlus from the BCVTB. An example model is shown in Figure 22.

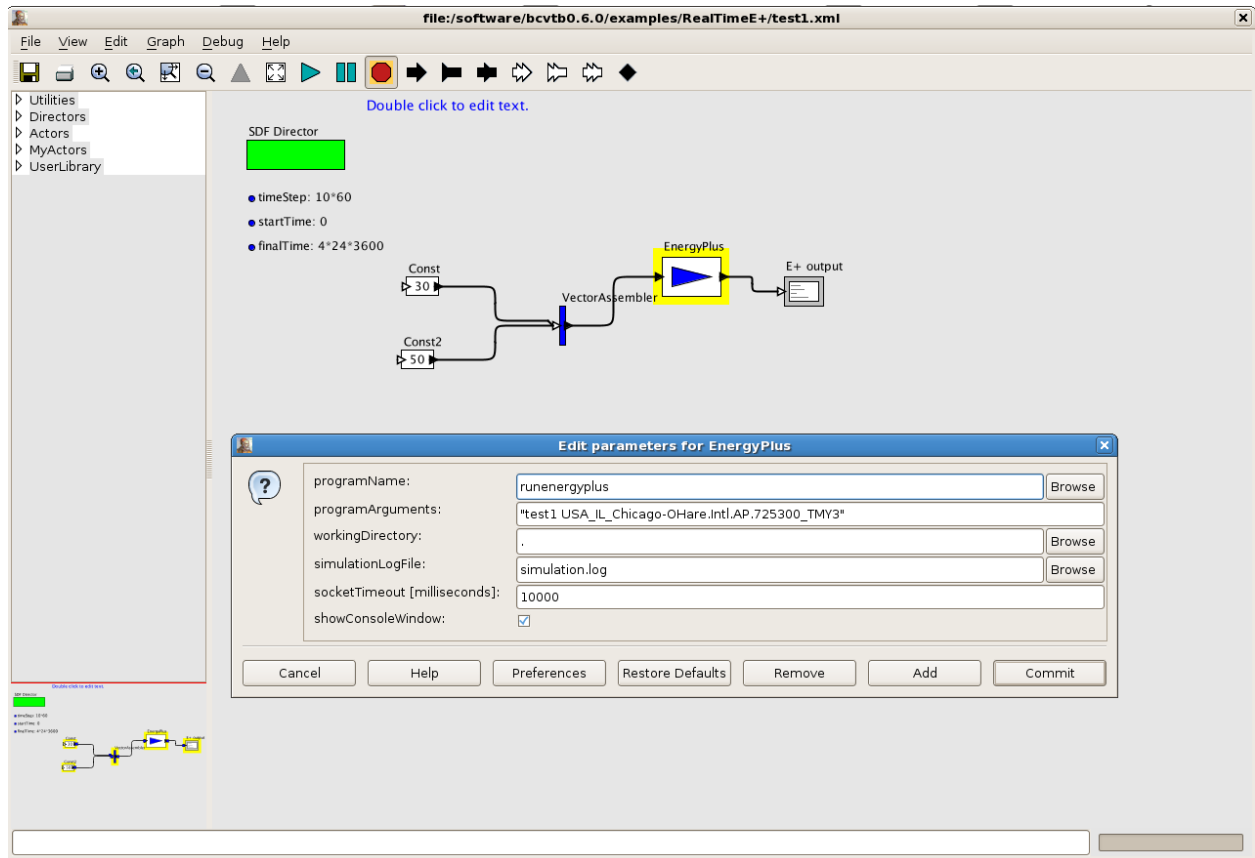

Figure 22 Ptolemy interface to setup EnergyPlus

Double clicking the EnergyPlus module, causes a configuration window to pop up. In the “programName” field, the default entry “runenergyplus” does not need to change. The “programArguments” field is about the only one that needs to be edited. In this example, the EnergyPlus idf file name is specified to be “test1”, as in the example, and the weather file name is specified to be “USA\_IL\_Chicago-OHare.Intl.AP.725300\_TMY3” as in the example. The working directory is the current directory and the console output is written to the file simulation.log. If EnergyPlus does not communicate with the BCVTB within 10 seconds, the BCVTB will terminate the connection, which is specified in the “socketTimeout” field.

The sampling interval can be specified by double clicking the SDF director. In this example, the time step is 10 minutes and the simulation period is four days. The same time step needs to be specified in the idf file.

## BCVTB setup

### Start-up

The following command starts the BCVTB module containing the BACnet and the database connector components. This should be started only after the database is started.

```
$java -jar BCVTB.jar -console
/software/bcvtb0.5/examples/bacnet/bacnet_bcvtb_database_site1.xml
```

A shortcut script has been created to perform this task.

\$/software/bcvtb\_database\_activity/bin/bcvtb\_restart

***In order to change the points list, the following steps have to be followed***

- 1) Make the appropriate changes in the xml file that holds the BACnet points list (fileA.xml).
- 2) Insert the correct xml filename (fileA.xml) into field “” in the file bacnet\_bcvtb\_database\_site1.xml.
- 3) Note the total number of BACnet points.
- 4) Insert that number in the “array extract” actor (if it is present).
- 5) Insert the number in the shell script.
- 6) If the BACnet server is providing a timestamp, the time strings have to be “array extract”ed and sent to the “System command” actor as inputs. If the BACnet server is not providing a timestamp, input1 and input2 of the “System command” actor should be set to “String constant” actors with a value of “no.”

***Commands to change just the number of points going into the database***

First find out the process ID of Ptolemy.

Kill this process. Then do the following.

```
$ vi /software/bcvtb0.5/examples/bacnet/bacnet_bcvtb_database_site1.xml
```

```
$ vi /software/bcvtb_database_activity/bin/DatabaseActivityWrapper.sh
```

```
$ nohup java -jar BCVTB.jar -console  
/software/bcvtb0.5/examples/bacnet/bacnet_bcvtb_database_site1.xml &
```

***Changing over to a newer version of BCVTB***

Copy the **bcvtb.version\_number** directory of the new version over to the production machine under the /software directory. Then the following directories on the production machine have to be copied from the earlier installation directory to the new installation directory.

```
/software/bcvtb.version_number/lib/ptII/myActors
```

```
/software/bcvtb.version_number/lib/ptII/bacnet
```

```
/software/bcvtb.version_number/lib/bacnet-stack
```

## **2.3 ADVANTAGES AND LIMITATIONS OF THE TECHNOLOGY**

This system differs from existing Energy Information Systems (EIS) in the following ways:

- Existing systems do not provide a means to compare actual performance to design intent. This system augments an existing EMCS with additional sensors and uses a whole building reference model and diagnostic software to make performance deviations visible.
- Existing systems neither provide a viable means to quantify the value of performance degradations, nor a methodology to quantify the value of corrective actions. This system employs a physics-based, calibrated energy model that is useful to ascertain the magnitude of performance deviations and also for estimating the economic value of corrective actions.

- Compared to purely rule-based technologies such as PACRAT [15], this system uses a physics based, whole-building energy model together with data mining such as clustering, change detection, and other data mining techniques for rigorous diagnosis.

Separately, each element represents a mature technology. Building simulation models are used routinely to design buildings, especially for comparing alternative HVAC systems and equipment, but rarely in building *operation* as implemented in this project. Instrumentation for performance monitoring systems is a mature commercial technology and a specification guide has been produced by LBNL [16]. Ptolemy II, as a platform for integration, has been demonstrated at LBNL [17, 18]. However, the innovation here is to assemble these parts into an integrated performance monitoring platform that uses a whole-building simulation model to generate reference values for whole-building performance metrics, compares these to actual measurements, and then processes the deviations using data mining methods to identify anomalies and generate recommendations.

The methodology used in this project is based on the use of a performance monitoring system integrated with a whole building simulation model to generate reference values for whole-building performance metrics, which enables a top-down energy efficiency evaluation as well as bottom up evaluation of component, systems, and end-uses. Baseline models of historic energy use are developed to track predicted and actual energy savings. This tool also identifies and diagnoses energy-related faults to ensure optimal energy efficiency. Key metrics are developed for each building to quantify energy savings from faults and savings from changes in operational parameters. This approach involves quantifying the performance of the building and then quantifying the identified savings based on a series of key metrics such as energy utility bill savings, energy metrics including electricity and fuel savings, plus reductions in greenhouse gas emissions including carbon dioxide.

The technical risks and the corresponding mitigations are summarized as follows:

1. The model calibration may be insufficient to discern differences between actual and desired building performance. An extensive and comprehensive sensitivity study is being used to characterize the behavior of the model. For selected outputs of interest (e.g. total electricity consumption at the whole building level etc.), the most influential input parameters are identified and further tuned by either hand or by automated optimizations.
2. The corrective actions required to address faulty operation or other deficiencies identified by the tool may require modifications to building systems that are outside the scope of this contract or substantial capital expenditures that are beyond the means of this contract. Mitigation efforts will focus on modifications to the control system that are realizable with minimal effort, and also on relatively simple fixes to the HVAC or lighting systems that fall within the expertise of the team and local facility staff.
3. The system compares baseline performance to post-corrective action. The comparison must be done under equivalent conditions (e.g., weather, usage) to be meaningful. Efforts have been made to ensure the baseline is generated for similar weather and occupancy conditions - in fact, the model based approach ensures this.
4. The relatively high implementation cost is the major limitation from this technology. The largest components are the equipment and installation costs related to submetering and the on-site weather station. It is possible and reasonable to eliminate on-site weather

station by using weather data from the internet or existing weather station on the base. A detailed cost analysis is provided in section 7.

5. A deployment concern about this technology is the skill level required to install and maintain the system. Another challenge is the efficient generation of simulation models of existing buildings from limited, often paper-based, design and as-built documentation. The current development of a comprehensive graphical user interface (GUI) for EnergyPlus by a team led by LBNL [19] will make a number of different aspects of modeling buildings, including existing buildings, simpler, faster and less prone to error. However, there are a number of aspects of modeling existing buildings that would be made more efficient by specific enhancements to this GUI.

### 3.0 PERFORMANCE OBJECTIVES

Table 1 below provides the basis for evaluating the performance of the proposed automated continuous commissioning of commercial buildings.

**Table 1 Performance Objectives**

<b>Performance Objective</b>	<b>Metric</b>	<b>Data Requirements</b>	<b>Success Criteria<sup>5</sup></b>
<b>Quantitative Performance Objectives</b>			
Reduce Building Energy Consumption (Energy) & Greenhouse Gas Emissions (CO <sub>2</sub> )	Building total electric consumption (kWh/(ft <sup>2</sup> -yr)) and peak demand (kW)  Building total steam consumption (therm/(ft <sup>2</sup> -yr)) and peak demand  Building total equivalent CO <sub>2</sub> emissions (kg)	Metering data for building electric and steam usage  Building simulation data for equivalent CO <sub>2</sub> emissions	>10% reduction in building total energy consumption and related costs (over baseline)  >15% reduction in building peak demand energy and related costs (over baseline)  >10% reduction in building total equivalent CO <sub>2</sub> emissions (over baseline)
Reduce HVAC Equipment Specific Energy Consumption (Energy)	Chiller (kW/ton) AHU (kW/ton) Fan (kW/CFM) Pump (kW/gpm)	Sub-metering data for HVAC equipment	>10% reduction in overall HVAC equipment specific energy consumption (over baseline)
Reduce Building Loads (Energy)	Lighting loads (kWh) Plug loads (kWh)	Sub-metering data for lighting and plug loads	5-10% reduction in lighting and plug loads and related costs (over baseline)
Building Model Validation	Building overall energy consumption (kWh/ft <sup>2</sup> -yr)  HVAC equipment energy consumption (kW)	Metering data for building electric and gas usage  Sub-metering data for HVAC equipment	Overall building energy consumption accuracy within +/- 15%  HVAC equipment energy consumption accuracy within +/-10%

<sup>5</sup> Success criteria related to building and HVAC equipment energy consumption have been assessed using both model-based simulations and actual energy measurements. Note: only those recommended energy fault corrective actions implemented by DOD facilities during the execution of this project could be assessed using actual energy measurements.

Automated Continuous Commissioning System Payback <sup>6</sup>	Simple payback time SIR (Savings-to-Investment Ratio) NPV (Net Present Value)	Cost to install and implement advanced building energy management system Savings from using advanced building energy management system	Simple payback time is less than 5 year <sup>7</sup> SIR is greater than 2.1. NPV is greater than 0
<b>Qualitative Performance Objectives</b>			
Ease of Use	Ability of an energy manager and/or facility team skilled in the area of building energy modeling and control to use the technology	Feedback from the energy manager and/or facility team on usability of the technology and time required to learn and use	An energy manager and/or facility team skilled in HVAC able to do automated commissioning of building with some training
Energy Fault Identification, Classification and Prioritization	Ability to detect, classify and prioritize (based on energy impact) building faults	Building measured data Building simulation data	Energy manager and/or facility team able to detect , classify and prioritize (based on energy impact) building faults by comparing simulated building performance (design intent or optimal) against measured building performance
Water System Fault Identification, Classification and Prioritization	Ability to detect, classify and prioritize water system faults	Building measured data Building simulation data	Energy manager and/or facility team able to detect , classify and prioritize building water system faults by comparing simulated building water consumption (design intent or optimal) against measured building water consumption

<sup>6</sup> This payback success criterion is only applied to the case when the only retrofits considered are those that do not involve major equipment retrofits

<sup>7</sup> DoD Energy Managers Handbook <http://www.wbdg.org/ccb/DOD/DOD4/dodemhb.pdf>



Energy Fault Corrective Action Prioritization	Ability to prioritize energy fault corrective actions based on energy impact	Building measured data Building simulation data	Energy manager and/or facility team able to prioritize energy fault corrective actions by comparing the simulated building energy impact benefits for each fault corrective action alternative against the simulated or measured baseline building energy performance
Water System Fault Corrective Action Prioritization	Ability to prioritize water system fault corrective actions	Building measured data Building simulation data	Energy manager and/or facility team able to prioritize water consumption corrective actions by comparing the simulated building water consumption benefits for each fault corrective action alternative against the simulated or measured baseline building water consumption performance
Automated Continuous Commissioning System Robustness	Percentage of faults classified correctly	Building energy/water faults identified/classified by automated continuous commissioning system	80% of faults identified are classified correctly (during 3 month demonstration period)

Each performance objective presented in the above table is described in the details that follow. Only those recommended energy fault corrective actions that are implemented by the DoD facilities team during the demonstration of this project could be assessed based on actual energy measurements.

### Quantitative Performance Objectives

1. *Reduce Building Energy Consumption (Energy) & Greenhouse Gas Emissions (CO<sub>2</sub>).*  
The ultimate goal of the whole-building performance monitoring and anomaly classification system is to reduce energy consumption, peak electric demand, greenhouse gas emissions, and water use in DoD facilities by providing actionable information to facility managers and building operators. The metrics used to assess this objective and the success criteria are listed as following:
  - Total electric consumption (kWh/(ft<sup>2</sup>-year)): 10% reduction over the baseline

- Peak electric demand (kW): 15% reduction over the baseline
- Total steam consumptions (therm/(ft<sup>2</sup>-year)): 10% reduction over the baseline
- Peak steam demand : 15% reduction over the baseline
- Total equivalent carbon dioxide (CO<sub>2</sub>) emissions (kg): 10% reduction over the baseline

These metrics are assessed with both model based simulations and actual energy measurement. The baseline building is the current as-built building without any energy fault corrective actions. The data required to calculate these energy-related metrics are metering data for building electric and steam usage. The simulation data are used for calculation of equivalent CO<sub>2</sub> emissions. Quantitative comparisons have been made between measured data from current as-built building and the post-commissioning building.

2. *Reduce HVAC Equipment Energy Consumption.* Energy consumption reduction is evaluated at the HVAC equipment level. The following metrics and criteria are used for the evaluation of individual equipment performance:

- Chiller (kW/ton): 10% reduction over the baseline
- Air handling unit – AHU (kW/ton): 10% reduction over the baseline
- Fan (kW/CFM): 10% reduction over the baseline
- Pump (kW/GPM): 10% reduction over the baseline

These metrics are assessed with HVAC equipment power sub-metering data and measurement of HVAC equipment airflow rates for fans and water flow rates for pumps.

3. *Reduce Building Loads (Energy).* Reducing building loads (e.g. lighting, plug) is an effective way to reduce building demand energy. It is quite common to find lighting and other equipment operating when it is unnecessary (e.g., lights on during unoccupied hours). The system is able to automatically detect this type of building usage anomaly. The following metric and criteria are used to assess this performance objective:

- Lighting loads (kWh): 5-10% reduction over the baseline
- Plug load (kWh): 5-10% reduction over the baseline

Sub-metering data for lighting and plug loads (electric equipment such as computers and printers) are used for the assessment of the above metrics.

4. *Building Model Validation.* One featured innovation from the proposed system is that it employs an integrated, whole-building simulation model. This model provides hourly calculation of building energy consumption, HVAC, lighting, and water systems performance, taking into account the dynamic interactions among the building envelope, airflow, weather, internal loads, building usage, equipment, and controls. The performance generated by this physics-based reference model, which represents “design intent” or ideal performance, is compared with measured data from the building. The performance deviation indicates sub-optimal operation or faults. One of the key elements

in the system is the validation of the reference model. The following metrics and criteria can be used to evaluate building model accuracy:

- Building overall energy consumption (kWh/(ft<sup>2</sup>-yr)): Accuracy within ±15% compared with real data.
- HVAC equipment energy consumption (kW): Accuracy within ±10% compared with real data.

Real time measured data were used to validate the building reference model. The measured data will include metering data for building electric and steam usage, and sub-metering data for HVAC equipment. Historical utility bills were also used for model validation.

The building reference model performance predictions are likely differ from the actual building performance measurements. However, given that this model contains a representation of the actual physics in the building, it can be used to assess the relative differences in building performance due to incremental building changes (e.g., control set-points, equipment faults). Therefore, while the overall absolute performance accuracy of the model may be ±15%, the model can be used assess the performance impact of incremental changes relative to a baseline, calibrated model configuration. Essentially, the relative model uncertainty for these building incremental changes will be significantly lower than the absolute model uncertainty. This will allow the impact on the project performance objectives to be assessed using the building reference models.

5. *Automated Continuous Commissioning System Payback Time.* As far as the economics and payback time are concerned, SIR (savings-to-investment ratio) and NPV (net present value) are used as metrics in addition to simple payback period. A practical SIR formula for building related project, recommended by NIST<sup>8</sup>, is used in this project:



- NPV: greater than 0. The investment would add value to the owner if NPV is greater than zero, which may result in the project being accepted.

In this project, SIR and SPB are calculated by using NIST BLCC program [20].

### **Qualitative Performance Objectives**

1. *Ease of Use.* The potential users of this system include the building energy manager and/or facility team who are skilled in the area of building HVAC systems (e.g., building energy modeling and controls). The feedbacks from these users on the usability of the technology and time required to learn and use this system have been used to help the project team to develop, evaluate, and refine the proposed system.
2. *Energy Fault Identification, Classification and Prioritization.* The system should enable the energy manager and/or facility team to detect, classify, and prioritize building energy system faults based on energy impact by comparing simulated building performance (design intent or optimal) against measured building performance. The system automatically identifies whole building performance deviations from the reference model by using mature methods such as cluster analysis and domain expertise, and enable root cause analysis of these deviations - not only identification of a pre-defined, rule-based, set of equipment faults. It also provides a means to prioritize the faults based on the energy impact. The data required to evaluate this metric are obtained from measurement and simulation.
3. *Water System Fault Identification, Classification and Prioritization.* The system should enable the energy manager and/or facility team to detect, classify, and prioritize building water system faults by comparing simulated building water consumption (design intent or optimal) against measured building water consumption. The data required to evaluate this metric are data from measurement and simulation.
4. *Energy Fault Corrective Action Prioritization.* The system should enable the energy manager and/or facility team to prioritize energy fault corrective actions by comparing the simulated building energy impact benefits for each fault correction action alternative against the simulated or measured baseline building energy performance. The physics-based, calibrated whole-building simulation model provides a means to evaluate the energy and economic value of alternative correction actions. The data required to evaluate this metric are obtained from measurement and simulation.
5. *Water System Fault Corrective Action Prioritization.* The system should enable the energy manager and/or facility team to prioritize water system fault corrective actions by comparing the simulated building water consumption benefits for each fault correction action alternative against the simulated or measured baseline building water consumption performance. The data required to evaluate this metric are obtained from measurement and simulation.
6. *Automated Continuous Commissioning System Robustness.* It is critical for the success of this project that the automated continuous commissioning system should be able to identify and classify building faults correctly. The criterion adopted is that, during the three-month demonstration period, 80% of the faults identified by the proposed system be classified correctly against the building facility manager and/or team assessment of fault causes.

The majority performance objectives were met during our demonstration. The exceptions include all the objectives related to water system. Based on the site visit and review with the facility manager at the Naval Station Great Lakes, water conservation is not viewed as a significant issue for buildings at Naval Station Great Lakes. The team collected water usage data from one of demonstration sites, Drill Hall (Building 7230), and made a conclusion to exclude the water system due to the following reasons:

1) There is currently no irrigation system at the Drill Hall

The average daily cold water usage for the Navy Drill Hall from December 2007 to November 2009 is only 380 gallons. The Navy Drill Hall currently uses high-efficiency water fixtures for all urinals and lavatory faucets in the five restrooms. The current water usage is already 30% less than a LEED building baseline. Figure 23 shows the actual daily water consumption from April 16<sup>th</sup> to May 16<sup>th</sup>, 2010, confirming that the current water usage in Drill Hall is not a significant issue.

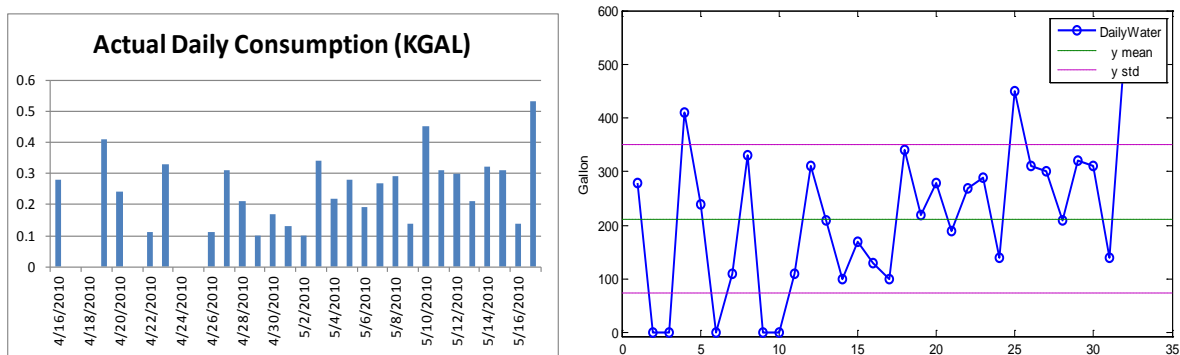

Figure 23 Actual water consumption in Drill Hall

2) Hot water energy consumption: At the Drill Hall, heating is supplied from the existing base-wide steam system through a steam-to-water heat exchanger. A performance objective related to reducing steam consumption had previously been included in the demonstration plan. In addition, the domestic hot water consumption is currently quite small.

The following faults are detected and diagnosed from the demonstrated sites: Building 7230 (Drill Hall) and Building 26.

- Economizer faults: too much outside air intake during non-economizer modes
- Lighting faults: lights on during unoccupied hours
- Plug load faults: excessive plug load due to occupant behaviors.
- Chiller faults: chiller was off when commanded on due to control issues. These cause AHU discharge air temperature cannot be maintained as well as room temperatures. This causes thermal comfort issues.

The summary of the identified savings and payback is provided in Table 2. More details about the performance assessment can be found from section 6.

**Table 2 Summary of selected energy savings strategies and associated payback**

<b>Selected energy savings strategies</b>	<b>Simulation- based savings (%) compared with current operation</b>	<b>Annual savings in \$*</b>	<b>Simple payback**</b>	<b>Building</b>
Lighting system (Occupancy based lighting control)	-23.14% (Total electricity)	\$6,542	Less than 2 months	Drill Hall
Reduce AHU1/2 outside air intake in the non-economizer mode	-40.49% (Total steam)	\$4,418	Less than 1 month	Drill Hall
AHU1/2 operation mode (operate AHU1/2 in parallel)	-2.06% (Total electricity) -31.21% (Fan electricity)	\$582	No initial cost	Drill Hall
Reduce plug load	-40.67%(Plug electricity) -22.32%(Total electricity)	\$4,119	No initial cost	BLDG 26

\*Assume 1) \$0.069 per kWh for the electricity; 2) \$8.7 per MMBTU for the steam

\*\* Only consider the capital cost required to implement these energy savings strategies.

## 4.0 FACILITY/SITE DESCRIPTION

The automatic continuous commissioning system continuously acquires performance measurements of HVAC, lighting, and plug usage from the existing building Energy Management and Control System (EMCS) augmented by additional sensors/meters as required. The system compares these measurements in real time to reference simulation models that represent the design intent for the building or have been calibrated to represent acceptable performance for the building through an integrated software environment. This software system is built upon the Building Control Virtual Test Bed [8, 13], where the reference model outputs are automatically assimilated with and compared to real time measurements.

The implementation of this system depends on the existing building control system communication capability. It is desirable that the existing EMCS should support open communication protocols such as BACnet, LonWorks, or Modbus. Another criterion for site selection is whether the building is undergoing a major renovation or has the renovation plan in the near future because this technology is intended to apply to buildings that are relatively stable.

Based on these criteria, two buildings at Naval Station Great Lake were selected as the demonstration site for this automatic continuous commissioning system.

### 4.1 FACILITY/SITE LOCATION AND OPERATIONS

#### Building 7230

The first identified demonstration site is Building 7230, the Naval Atlantic Drill Hall, at Naval Training Center, Great Lakes, IL. It is a two-storey facility with a drill deck, office, and administrative rooms. The gross area of this building is approximately 69,218 ft<sup>2</sup>. Figure 4 shows the location of this building schematically and with a map (Building 7230 is identified with a yellow star on the map).

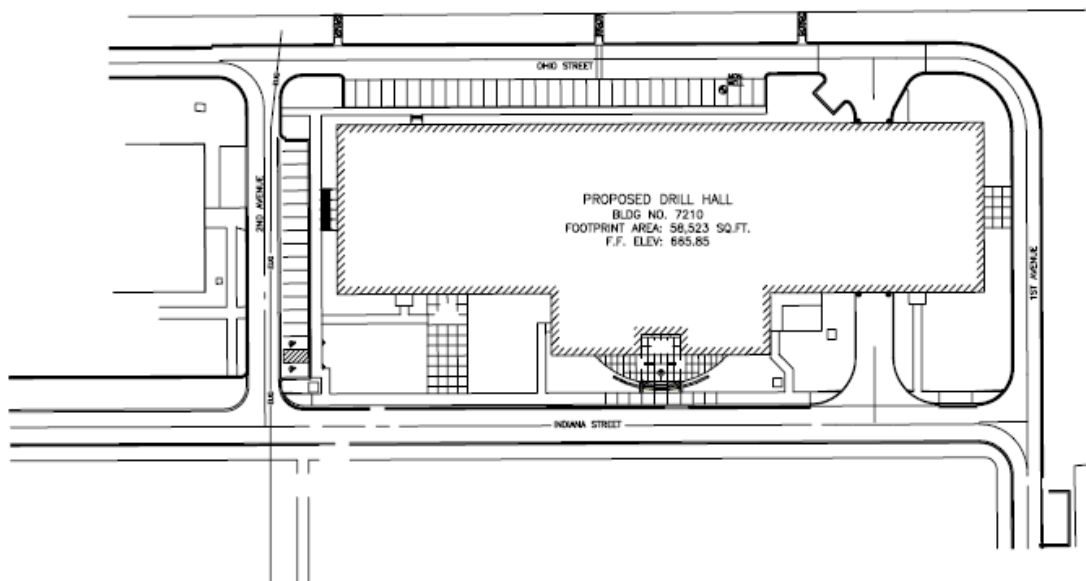



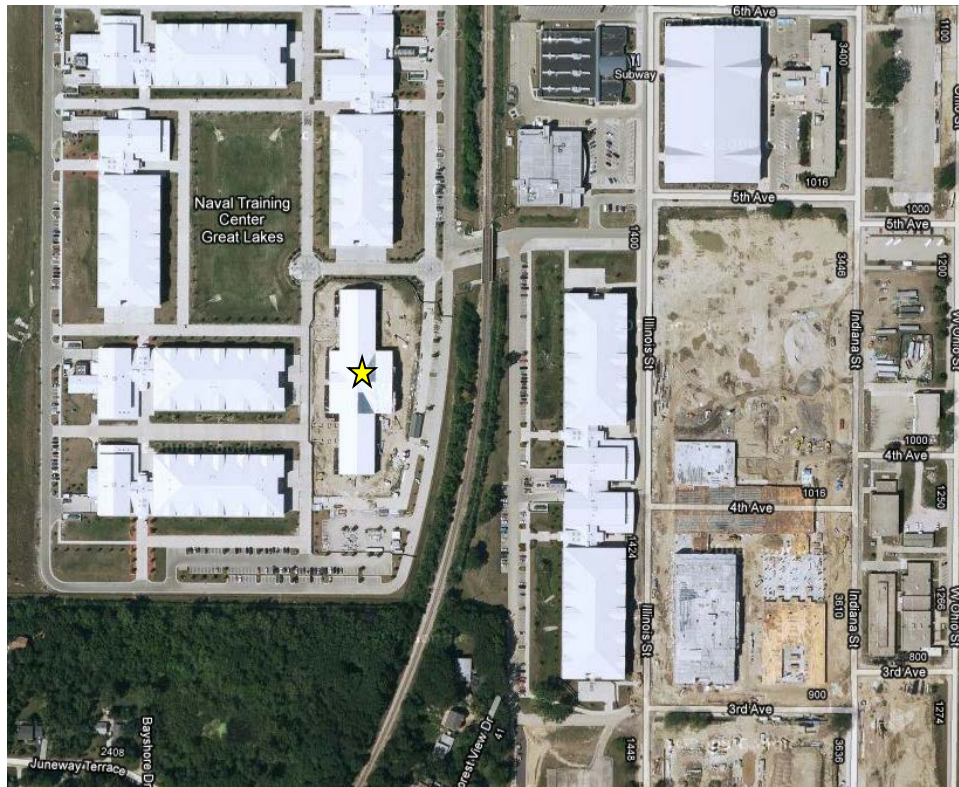

Figure 24 Location of Building 7230

### Building 26

The second identified demonstration site is Building 26, Fleet and Family Support Center (FFSC)/Navy Marine Corps Relief Society (NMCRS), at Naval Training Center, Great Lakes, IL. It is a two-storey office building with basement. The gross area of this building is approximately 37,000 ft<sup>2</sup>. Figure 25 shows the outlook and the location of this building schematically and with a map (Building 26 is identified with a yellow star on the map).



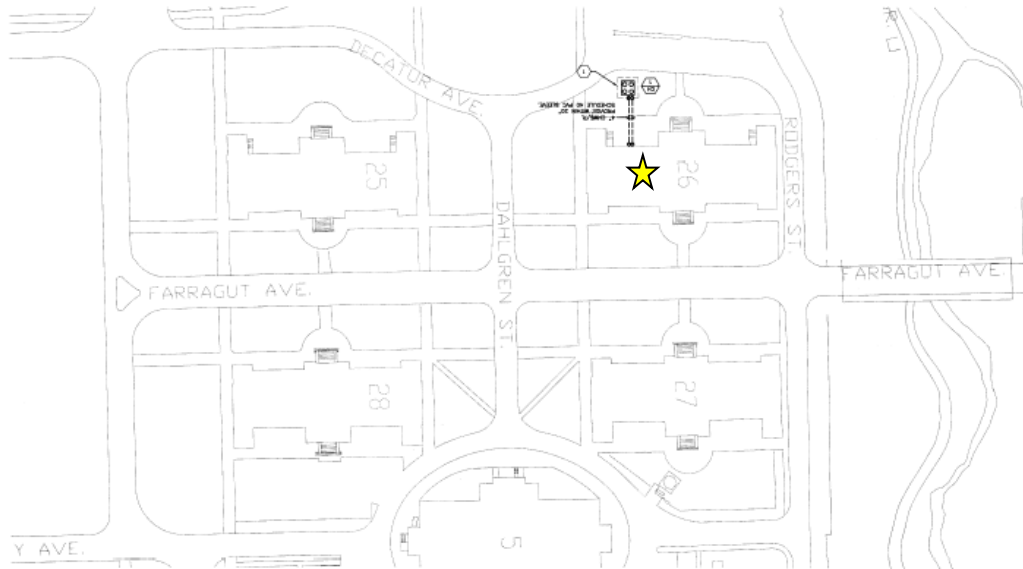

Figure 25 Location of Building 26

## 4.2 FACILITY/SITE CONDITIONS

### Building 7230

The Drill Hall HVAC system consists of four airside systems and two separate waterside systems. The Drill deck is supplied by two variable-air volume (VAV) air handling units with heating and cooling capability. Operation of these units depends on the occupancy of the Drill deck space. Double-walled sheet metal ductwork with a perforated liner and drum louvers distribute the air throughout the space. The office and administrative area is served by one VAV air handling unit with VAV terminal units (with hot water reheat). The Classroom is served by one VAV air handling unit. The chilled water system consists of two 100-ton air-cooled rotary-screw type chillers with fixed-speed primary pumping and variable-speed secondary pumping. Heating is supplied from the existing base-wide steam system through a steam-to-water heat

exchanger. The hot water serves unit heaters, VAV box reheating coils, and air handling unit heating coils. There is an instantaneous stream-to-domestic hot water generator for domestic hot water service. The server room and communication service room are served by dedicated split systems. Table 3 lists major HVAC equipment used in building 7230.

**Table 3 Major Equipment Used in Building 7230**

Equipment	Number	Manufacturer
Duct free split system	2	Carrier
Air cooled screw chiller	2	Carrier
Variable volume AHU	4	Carrier
Duct free split system	2	Carrier
Suspended unit heater	7	Vulcan
Cabinet unit heater	3	Vulcan
VAV box with hot water reheat coil	8	TITUS
Pumps	7	Bell & Gossett

A distributed DDC control system, APOGEE™ Insight by Siemens Building Technologies is installed in this building. Building electric and water meters are also read by the DDC system. Operator workstations provide graphics with real-time status for all DDC input and output connections.

### **Building 26**

The Building 26 HVAC system consists of two airside systems and two separate waterside systems. The office and administrative area on the first and second floors is served by two variable-air volume (VAV) Air Handling Units(AHU) with VAV terminal unit (with hot water reheat) heating and cooling capability. These AHUs have both heating and cooling capability. Operation of these units depends on the occupancy of the building. The chilled water system consists of one 54.5-ton air-cooled rotary-screw type chillers with fixed-speed primary pumping. Heating is supplied from the existing base-wide steam system through a steam-to-water heat exchanger. The hot water serves unit heaters, VAV box reheating coils, and air handling unit heating coils. The communication service room is served by one dedicated split system. Electric unit heater and baseboard are used to provide heating to stairwells and restrooms. Table 4 lists major HVAC equipment used in Building 26.

**Table 4 Major equipment used in Building 26**

Equipment	Number	Manufacturer
Duct free split system	1	Carrier
Air cooled screw chiller	1	Carrier
Variable volume AHU	2	Carrier
Duct free split system	2	Carrier
Hydronic unit heater	4	Sterling

Electric unit heater	2	Qmark
Electric baseboard	4	Qmark
VAV box with hot water reheat coil	38	TITUS
Pumps	6	Bell & Gossett

A distributed DDC control system, APOGEETM Insight by Siemens Building Technologies is installed in this building. This system monitors all major environmental systems. Building electric and water meters will be read by the DDC system. Operator workstations provide graphics with real-time status for all DDC input and output connections.

## **5.0 TEST DESIGN**

### **5.1 CONCEPTUAL TEST DESIGN**

The technology has been demonstrated at the Naval Station Great Lakes facility. The demonstration was carried out in two phases:

- Phase 1: Models were constructed and calibrated based on as-built drawings and other reference material. Building instrumentation was deployed and data collected. An off-line comparison between model predictions and building measured data was performed to identify potential corrective actions that will improve building performance.
- Phase 2: The building reference model and data mining / anomaly detection algorithms were integrated using the BCVTB, and a real-time performance assessment was conducted.

The first demonstration site identified is Building 7230, the Navy Atlantic Drill Hall, at Naval Station Great Lakes, IL. It is a two-floor facility with a drill deck, office, and administrative rooms. The gross area of this building is approximately 69,218 ft<sup>2</sup>. A networked Siemens APOGEE™ direct digital control (DDC) system monitors all major lighting and environmental systems. Building, power, and hot water meters are also read by the DDC system. Operator workstations provide graphics with real-time status for all DDC input and output connections.

Additional metering was installed to calibrate models and accurately measure energy consumption to validate results. It is important to emphasize that most of this instrumentation was required only to validate results. Deployment of this technology beyond the first two demonstration sites should require significantly less additional instrumentation. For Building 7230, the added-on sensors instrumentation include a DEM (digital energy meter- electrical) for chiller, a matched pair of supply and return chilled water temperature sensors, a pyranometer, and aspirated wet and dry bulb temperature sensors for the weather station. These sensors were integrated into the Siemens EMCS, and a BACnet server was installed to enable information to flow to a computer located within the building. This computer is hosting the BCVTB, the reference EnergyPlus model and the information system.

### **5.2 BASELINE CHARACTERIZATION**

Two baseline models were developed, to serve two different purposes:

#### 1) Existing operation baseline model

The existing operation baseline model refers to a whole-building EnergyPlus simulation model that represents the current building operational practice. The model takes as input a description of the building (e.g., location, orientation, geometry, shading, envelope material and construction), weather, lighting and plug load profile, occupancy, HVAC system sequence of operation and water usage. It then computes the building energy consumption for HVAC system, lighting and plug loads and water consumption at the time step of a fraction of an hour (typically 15 minutes).

The building description was obtained from the design documentation and the as-built drawings. In cases where some information is not available, either an on-site investigation or an empirical estimate would be used to determine these parameters. The HVAC system sequence of operation

was obtained by combining the information from the control design documents, existing Energy Management Control System (EMCS) programming and interviews with the building operators and Siemens control engineers. The weather data, including solar irradiation, outside air temperature and relative humidity and wind speed and direction were collected from the augmented on-site weather station. The lighting and plug load profiles were obtained from the additional building level sub metering. If sub metering is not available, a onetime measurement along with occupancy profile can be used to determine the lighting and plug load profile. The real occupancy profiles were estimated based on a one time investigation during a typical weekday. Real-time load profiles were assessed using a load estimator [21]. A model-based estimation approach was used here to provide real-time estimates of internal loads at multiple scales within the building. The estimation was built upon a reduced-order building model from the building thermal network and real-time data (e.g., temperatures, airflow rates) from the EEMCS, with considerations for sensor noise and model uncertainties. Some estimated internal load plots are included in Appendix F.

After the initial model was built, a calibration process was applied to match the simulation results with the measured data by tuning the model input data. Detailed about the proposed automated calibration procedure can be found from Appendix E.

This model has two major functions: 1) to analyze and prioritize corrective action alternatives and 2) to quantify the building performance impact following implementation of the corrective actions.

## 2) Design intent baseline model

The design intent baseline model represents the design intent/desired performance of the building. The design intent and operation models share the same model inputs for building information and weather data but differ in the description of the HVAC system operation, lighting and plug load profile, and water usage. In the design intent baseline model, the HVAC sequence of operation stand for the initial design intent or the desired performance that the facility management team is attempting to achieve based on the capability of existing equipment. The lighting and plug load profile in the design intent baseline model signifies an “ideal” performance that has only minimum lighting and plug loads on during unoccupied hours and lighting and plug loads proportional to the occupancy profile during occupied hours. The water usage is strictly proportional to the occupancy profile at all times.

By comparing to the measured data, the design intent baseline model was be applied to identify and quantify the building energy and water consumption deviations from design intent or desired performance.

## **5.3 DESIGN AND LAYOUT OF TECHNOLOGY COMPONENTS**

### **5.3.1 Instrumentation and Monitoring**

The automatic continuous commissioning system continuously acquires performance measurements of HVAC, lighting, and water usage from the existing building Energy Management and Control System (EMCS) augmented by additional sensors/meters as required.

Additional instrumentation is required to provide run-time model inputs, calibrate models and accurately measure energy consumption to validate results. It is important to emphasize that most

of this instrumentation is required only to validate results and deployment of this technology beyond the first two demonstration sites should require significantly less additional instrumentation. The measurements related to run-time weather inputs are outdoor dry bulb temperature, outdoor relative humidity, direct normal solar radiation, diffuse solar radiation, and wind speed and direction. Modern buildings equipped with the EMCS commonly have the outdoor dry bulb temperature and relative humidity measurements available, while the measurements, such as wind speed and direction, direct normal solar radiation, and diffuse solar radiation, are not typically available. Those missing measurements should be installed according to the manufacturers' instructions or industry standards.

The additional measurements required to track key performance metrics are electrical power submetering and thermal energy consumption for cooling and heating. The submetering of the electrical power should be able to measure the whole building electrical power and separate the lighting electrical power, plug load electrical power and HVAC equipment electrical power. The additional hardware and software necessary to implement the Automated Continuous Commissioning System for Bldg 7230 and Bldg 26 are listed in Table 5 and Table 6 respectively. All of the building performance monitoring points that are required for these two buildings are listed in Table 7 and Table 8. The locations for the additional instrumentation for Bldg 7230 are shown in Figures 26 to 28. The locations used for installing the additional instrumentation for Bldg 26 are shown in Figures 29 to 31.

The measurement accuracy of the weather station used in the two demonstration sites is listed Table 9. The measurement accuracy of the submetering for electricity and thermal energy refers to Specifications Guide for Performance Monitoring Systems (<http://cbs.lbl.gov/performance-monitoring/specifications/>).

With the purpose of proof-of-concept demonstration, the high quality instrumentation was used in the project to provide a robust and reliable measurement system to minimize the uncertainties associated with the influence of the weather.

**Table 5 Additional system tool components for Bldg7230**

Component	Quantity	Note
PC	1	Host the automated continuous commissioning tool
Siemens BACnet Server	1	Establish the communication capability between the Siemens APOGEE™ system and the BCVTB.

**Table 6 Additional system tool components for Bldg26**

Component	Quantity	Note
PC	2	One for running Siemens Insight EMCS software and one for running the automated continuous commissioning tool.
Siemens Insight Basic EMCS software	1	
Siemens BACnet Server	1	Establish the communication capability between the Siemens APOGEE™ system and the BCVTB.

**Table 7 Performance monitoring points list for Bldg 7230**

Point needed	Status		Note
	New	Existing	
Outside air temp	X		Aspirated weather station is required.
Outside air wet bulb	X		
Pyranometer	X		
Wind speed & direction	X		
Main power meter		X	
Lighting load power	X		The potential location is shown in Figure 26.
Plug load power	X		The potential location is shown in Figure 26.
Chiller 1& 2 power	X		Power meters to be installed are shown in Figure 26.
CHW Primary Pump 1, 2 & 3 power	X		Due to the small size of these pumps, a one-time power measurement is adequate.
CHW Secondary Pump 1& 2 power		X	Utilize the VFD power measurement.
CHW supply temp	X		Matched pair sensors are recommended and the potential location is shown in Figure 27.
CHW return temp	X		Matched pair sensors are recommended and the potential location is shown in Figure 27.
CHW flow meter	X		The potential location is shown in Figure 27.
HW Pump 1& 2 power			Utilize the VFD power measurement.
HW supply temp	X		Matched pair sensors are recommended and the potential location is shown in Figure 28.
HW return temp	X		Matched pair sensors are recommended and the potential location is shown in Figure 28.
HW flow meter		X	The potential location is shown in Figure 28.
AHU Supply Fan 1, 2, 3 & 4 fan power		X	Utilize the VFD power measurement.
AHU Return Fan 1, 2, 3 & 4 fan power		X	Check the VFD for power output signal.
Zone temperatures		X	



Zone Relative Humidity (RH)		X	Drill deck RH will use AHU 1&2 Return air RH.
VAV Box damper position		X	
VAV Box flow		X	
VAV Box reheat coil valve		X	
AHU 1, 2, 3 & 4 Supply Air Temperature		X	
AHU 1, 2, 3 & 4 Mixed Air Temperature		X	Averaging sensors are recommended.
AHU 1, 2, 3 & 4 Return Air Temperature		X	
AHU 1, 2, 3 & 4 static pressure		X	
AHU 1, 2, 3 & 4 air flow		X	
AHU 1,2,3&4 heating coil		X	
AHU 1, 2, 3 & 4 cooling coil		X	
AHU 1, 2, 3 & 4 economizer damper position		X	
Duct free split system 1 & 2 power	X		Due to their small size, a one-time measurement is adequate.
Domestic water flow	X		A domestic water flow meter is available and will hook up with EMCS.

**Table 8 Performance monitoring points list for Bldg26**

Point needed	Status		Note
	New	Existing	
Outside air temp	X		Aspirated weather station is required.
Outside air wet bulb	X		
Pyranometer	X		Provides measurements on global horizontal solar radiation, beam radiation and diffuse

			solar radiation.
Wind speed & direction	X		
Main power meter	X		
Lighting load power	X		The potential location is shown in Figure 29.
Plug load power	X		The potential location is shown in Figure 29.
Chiller 1 power	X		Power meters to be installed are shown in Figure 29.
CHW pump 1& 2	X		Constant speed pump and one time power measurement is good enough.
Cooling energy	X		BTU meter should also output CHW supply/return temperature and CHW flow rate. The potential location is shown in Figure 30.
Heating energy	X		BTU meter should also output HW supply/return temperature and HW flow rate. The potential location is shown in Figure 31.
HW Pump 1&2 power		X	Utilize the VFD power measurement.
AHU Supply Fan 1&2 fan power		X	Utilize the VFD power measurement.
AHU Return Fan 1&2 fan power		X	Check the VFD for power output signal.
Zone temperatures		X	
VAV Box damper position		X	
VAV Box flow		X	
VAV Box reheat coil valve		X	
AHU 1& 2 Supply Air Temperature		X	
AHU 1&2 Mixed Air Temperature		X	Averaging sensors are recommended.
AHU1& 2 Return Air Temperature		X	
AHU 1& 2 static pressure		X	
AHU 1&2 air flows		X	Including supply air flow, return air flow and OA flow.

AHU 1& 2 heating coil valve position		X	Using the EMCS output control signal as the indicator of the valve position.
AHU 1& 2 cooling coil valve position		X	Using the EMCS output control signal as the indicator of the valve position.
AHU 1& 2 economizer damper position		X	Using the EMCS output control signal as the indicator of the valve position.
Duct free split system 1 &2 power	X		Due to their small size, one time measurements will be adequate.
Domestic water flow	X		A domestic water flow meter is available and will hook up with EMCS.

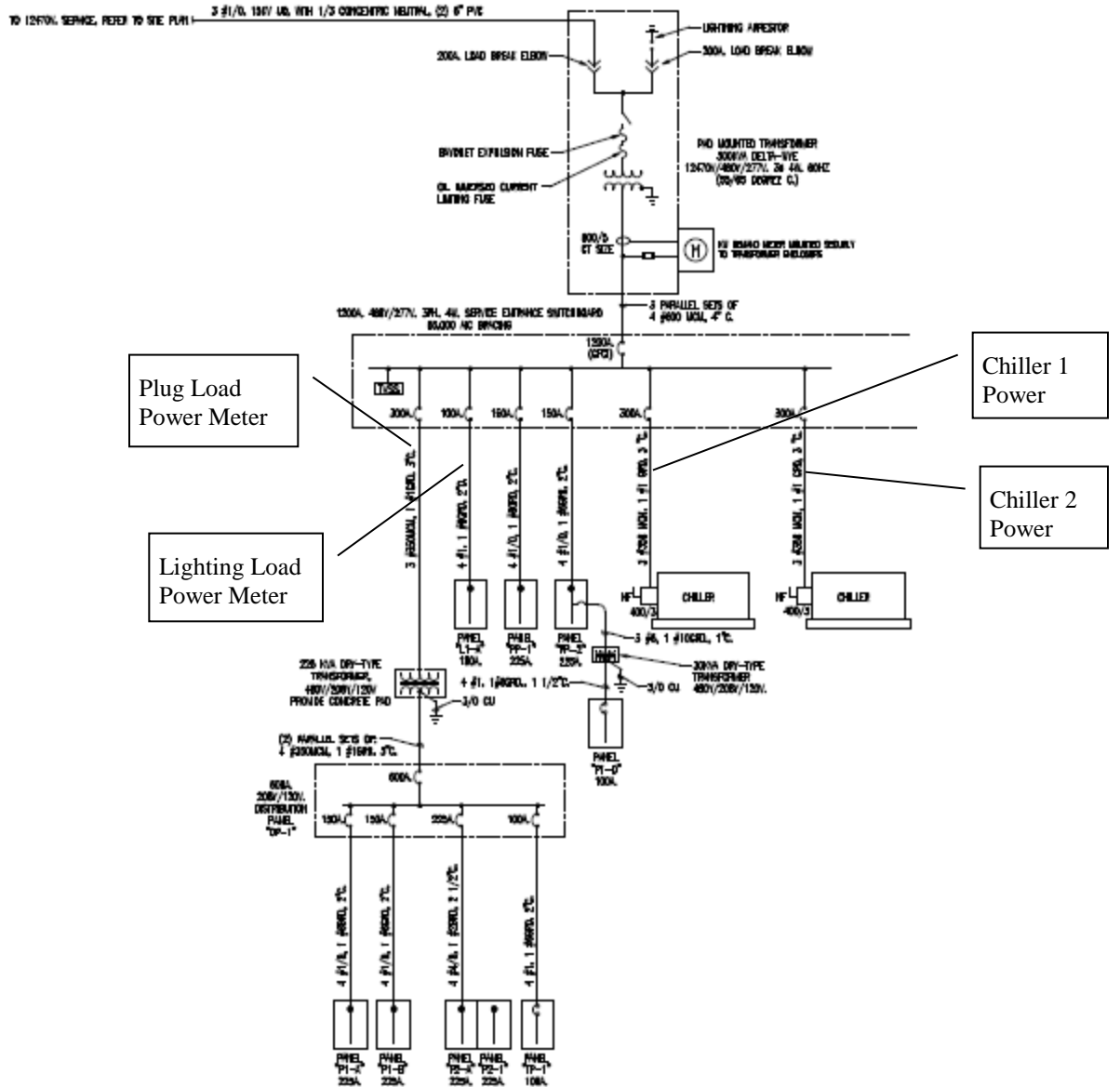

Figure 26 Location of additional power meters for Bldg 7230

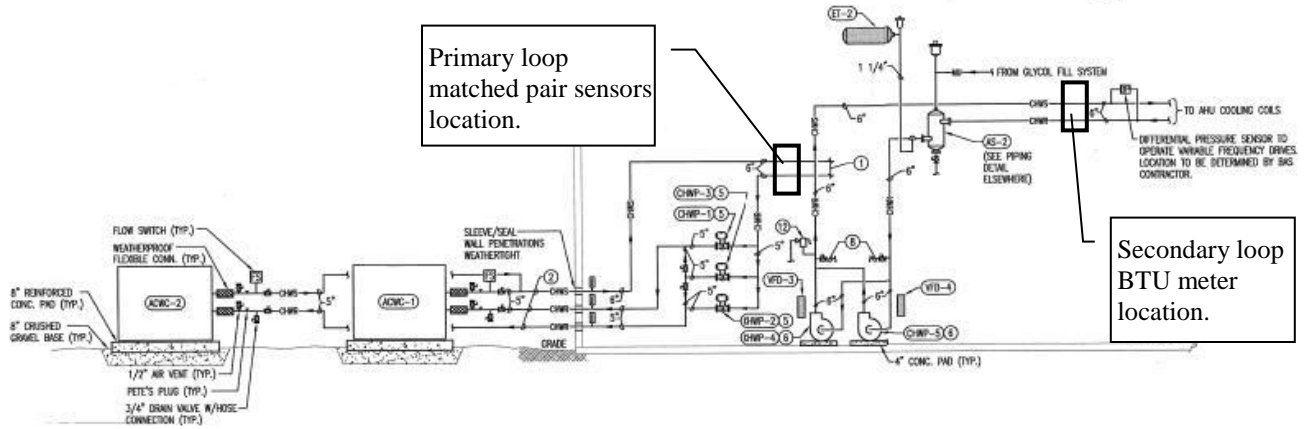

Figure 27 Locations for chilled water thermal energy and primary loop supply and return water temperature sensor for Bldg 7230

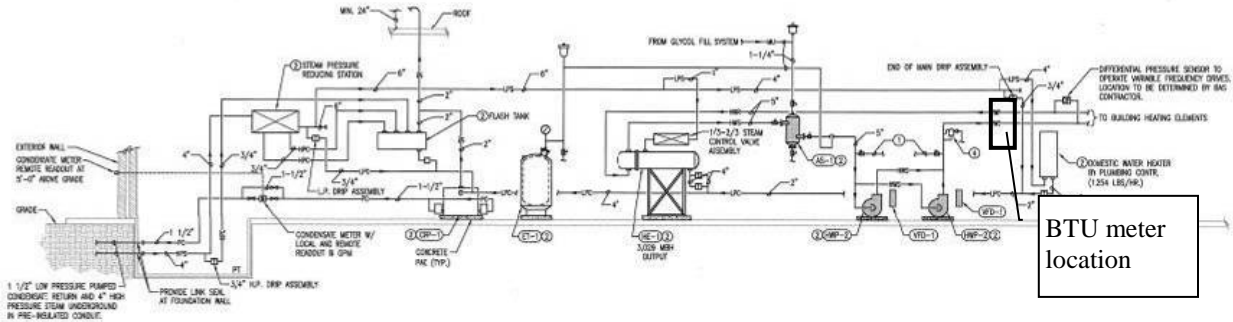

Figure 28 Location for hot water thermal energy meter for Bldg 7230

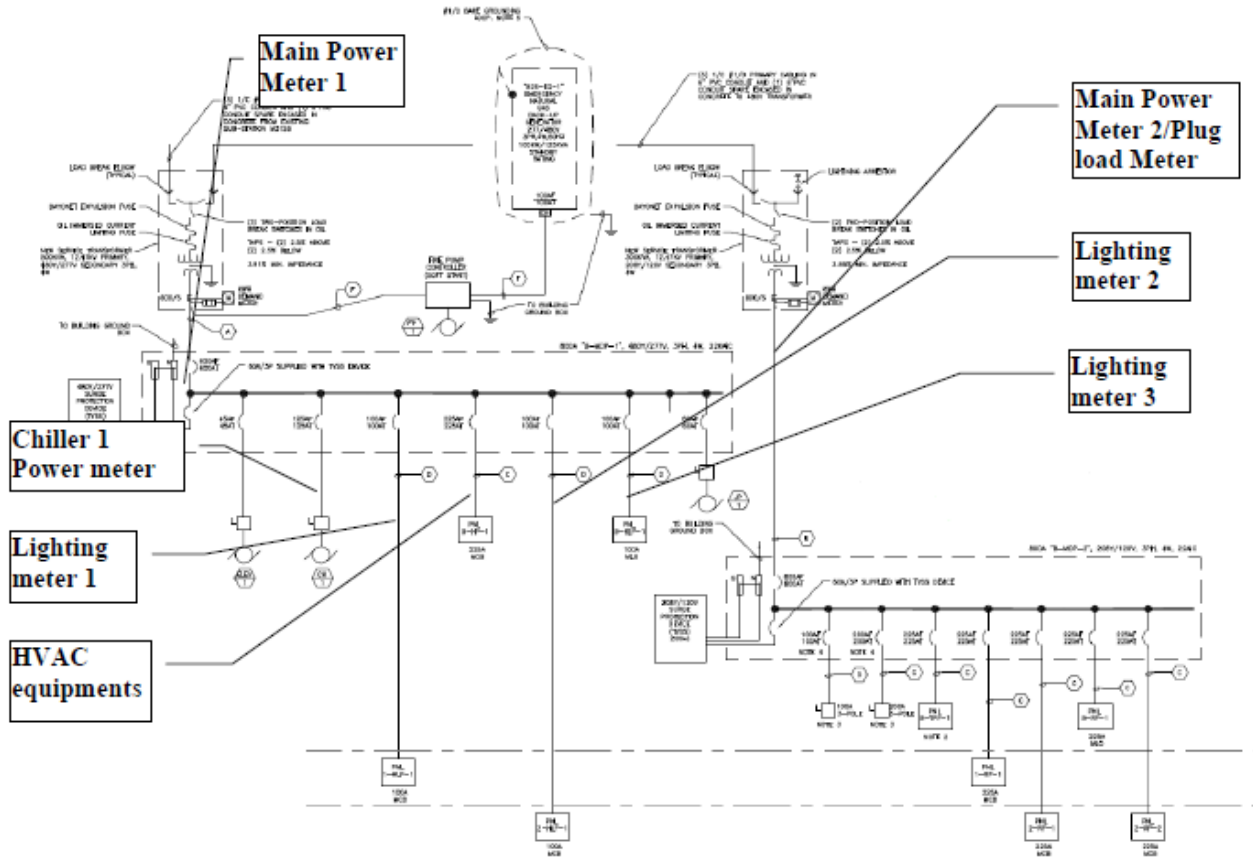

Figure 29 Locations of additional power meters/CTs for Bldg26

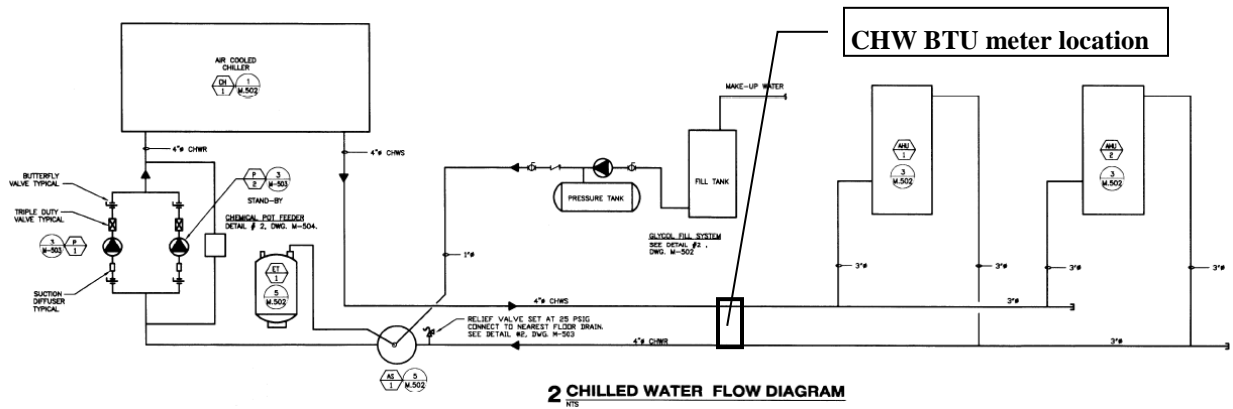

Figure 30 Locations for chilled water BTU meter for Bldg26

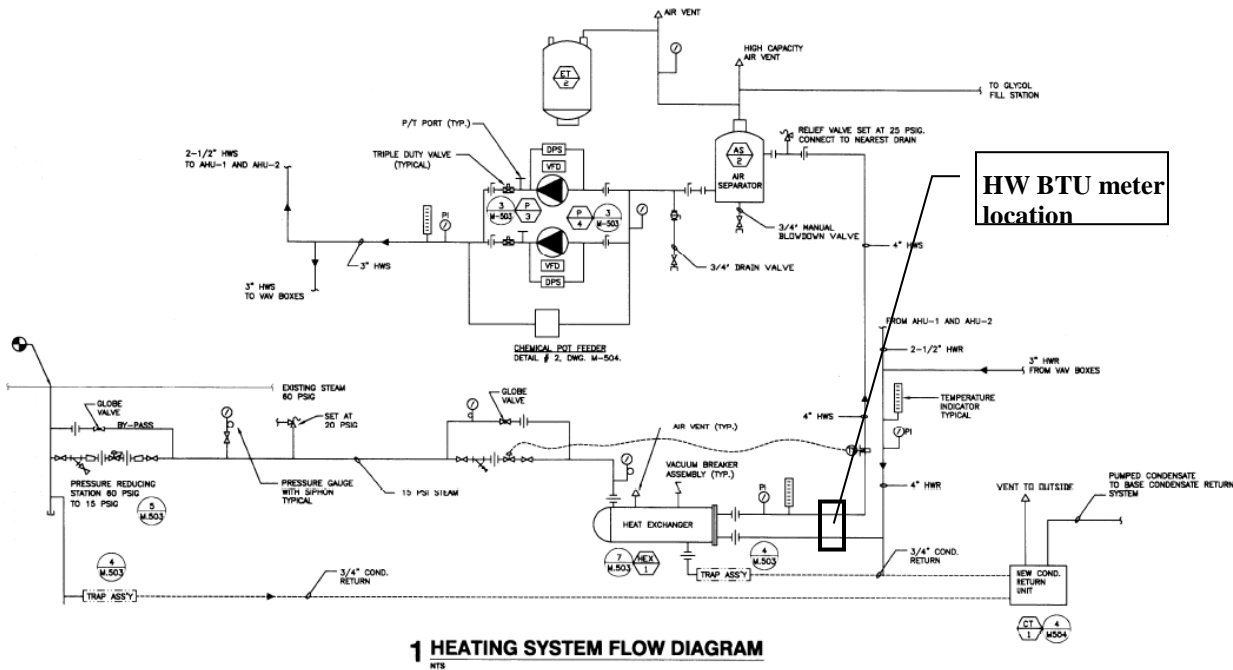

Figure 31 Locations for hot water BTU meter for Bldg26

**Table 9 Weather station measurement accuracy**

Weather Measurement	Measurement Accuracy
Outdoor air dry bulb	0.18°F (0.1°C)
Outdoor air relative humidity	(1.0+0.008×reading)% RH
Wind speed	0.2 MPH (0.09 m/s)
Wind direction	5 degrees
Direct normal solar radiation	2% of full scale
Diffuse solar radiation	2% of full scale

### 5.3.2 Performance Monitoring System PC Server

The overall system schematic diagram is shown in Figure 32. The PC server running the Automated Continuous Commissioning System is located in the same building location as the PC running the EMCS. The required building performance data are collected through the existing EMCS and then made accessible to the Automated Continuous Commissioning system through a BACnet interface.

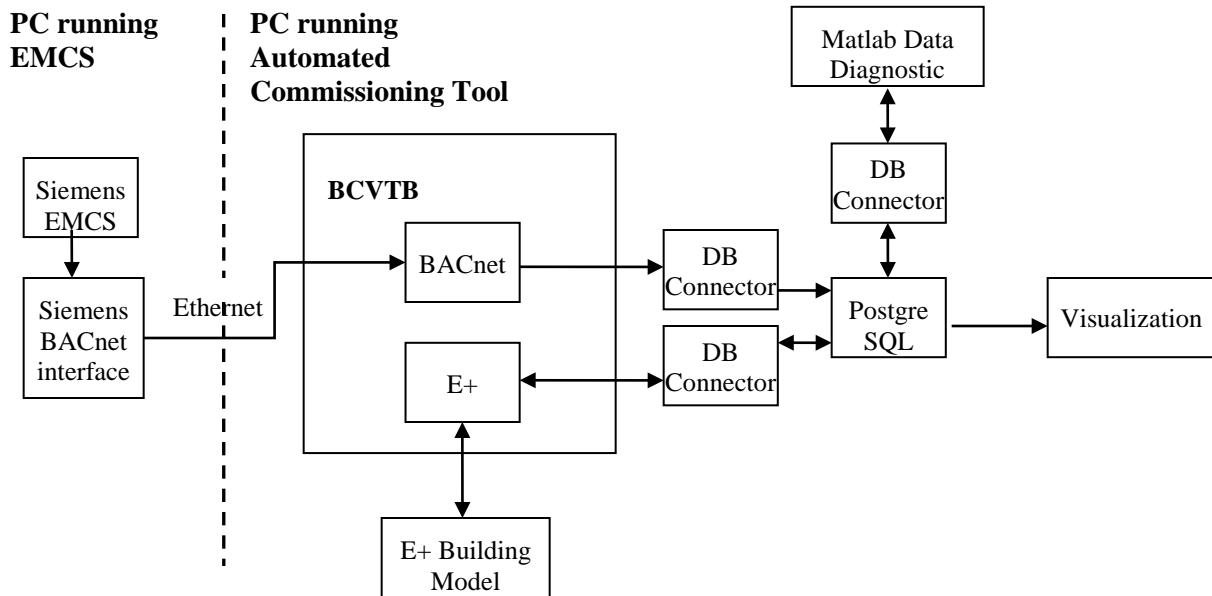

Figure 32 System schematic diagram

Within the Building Control Virtual Test Bed (BCVTB), there are two modules necessary to achieve the Automated Continuous Commissioning System functional requirements. The BACnet module is used to acquire the relevant building performance data from the Siemens BACnet interface through an Ethernet connection. The sampling interval is 5 minutes. The data then is transferred to the PostgreSQL database through the Database (DB) Connector tool. The EnergyPlus (E+) module establishes the communication between the BCVTB and an external pre-built and calibrated EnergyPlus model that represents the design/optimal building performance. The EnergyPlus simulation time-step is 15 minutes. The EnergyPlus module receives the relevant data (e.g., weather data) and executes the external EnergyPlus reference model. The EnergyPlus simulated results then are passed back to the DB through its dedicated DB connector tool.

The Matlab Data Diagnostic tool communicates with the Database Software through its dedicated DB connector tool. The Data Diagnostic tool applies data mining and anomaly detection methods to identify building faults using building measurements and building reference model predictions data stored in the DB. This tool executes once an hour.

The Visualization is the user interface to demonstrate the results as well as to display the real-time building performance data. It should be noticed that the BCVTB, the EnergyPlus building model, the Matlab Data Diagnostic and database software are running in the background and not visible to the user.

## 5.4 OPERATIONAL TESTING

The Automated Continuous Commissioning system runs as an application on a PC at each of the two demonstration buildings. The BCVTB runs as a background application on this PC to automatically invoke the different Automated Continuous Commissioning functional modules (BACnet, data base, EnergyPlus, data mining). A visual user interface application is available on the PC desktop. This user interface application allows the facility team to plot the real-time



comparison between building energy consumption data and the EnergyPlus model output. The user interface application also allows the facility team to conduct real-time comparisons of the reference model output to the building measurements, and to automatically identify which building performance metrics are anomalous and how corrective actions should be prioritized.

After the demonstration, the Automated Continuous Commissioning system will be left in place and turned over to the site facility management team.

## 5.5 SAMPLING PROTOCOL

The existing Siemens APOGEE™ EMCS collects all the building performance data, including the additional measurement data for this project. The data communication within the APOGEE™ system is accomplished by Siemens proprietary protocol. In order to acquire the relevant data for this demonstration project, an APOGEE™ BACnet interface was installed. This BACnet interface allows the existing Siemens EMCS to exchange data with the external BCVTB environment using the BACnet protocol. The existing data scan intervals used in the Siemens APOGEE™ EMCS are matched by the BACnet module within the BCVTB environment to ensure the collection of sufficient data to represent the real-world building operating conditions.

BACnet is a communication protocol for building automation and control networks. It is an ASHRAE, ANSI, and ISO standard protocol. BACnet was designed to allow communication of building automation and control systems for applications such as heating, ventilating, and air-conditioning control, lighting control, access control, and fire detection systems and their associated equipment. The BACnet protocol provides mechanisms for computerized building automation devices to exchange information, regardless of the particular building service they perform.

The BACnet module in the BCVTB serves to acquire the relevant building performance data from the Siemens BACnet interface. The communication is being established through an Ethernet connection. Data quality control information is provided in Appendix B. Information about the data sampling is presented in Section 5.3.2 and the relevant building performance sampling points to be collected are presented in Tables 7 and 8 in Section 5.3.1.

## 5.6 SAMPLING RESULTS

Table 10 lists summary information regarding the data collected in this project. All the data are included, in Excel csv format, in the CD delivered with final report.

**Table 10 Building data facts**

Building	Data points	Sampling frequency	Duration	Measurement variables
BLDG7230	688	5 minutes	04/12/2010 to present	Temperatures, water flow rates, air flow rates, damper/valve positions, duct pressure, setpoints, control outputs (command)
BLDG26	1062	5 minutes	03/03/2011 to present	

Figures 32 to 36 show some example data plots for some data taken from Drill Hall from October 1<sup>st</sup>, 2010 to October 10<sup>th</sup>, 2010.

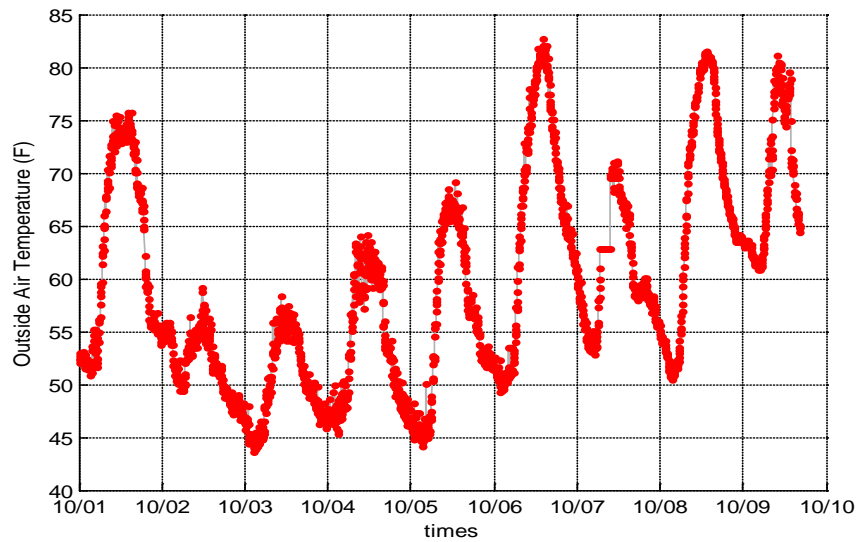

Figure 32 Drill Hall outside air temperature

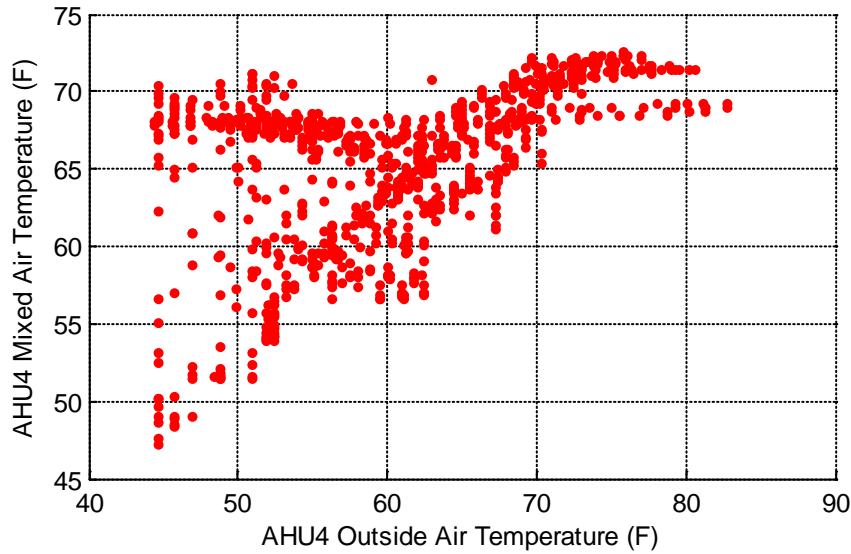

Figure 33 Drill Hall AHU4 outside air temperature vs. mixed air temperature

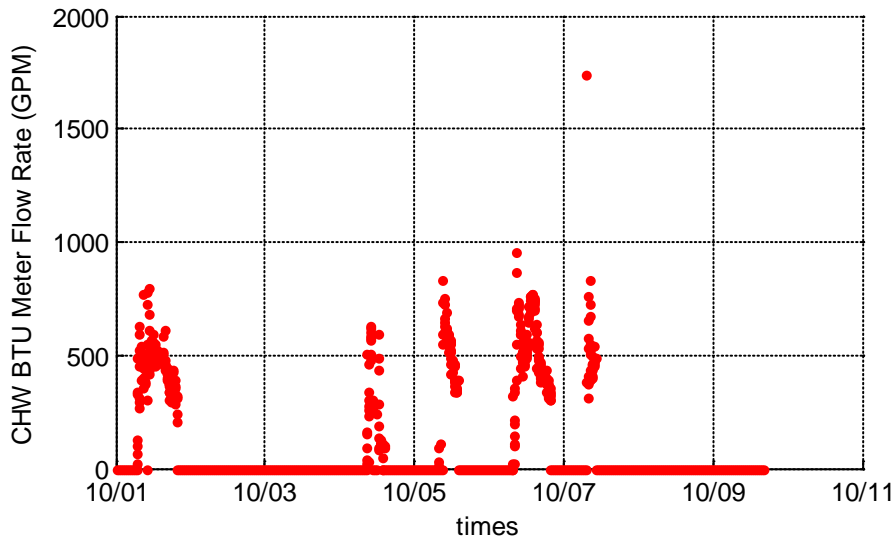

Figure 34 Drill Hall secondary loop chilled water flow rate

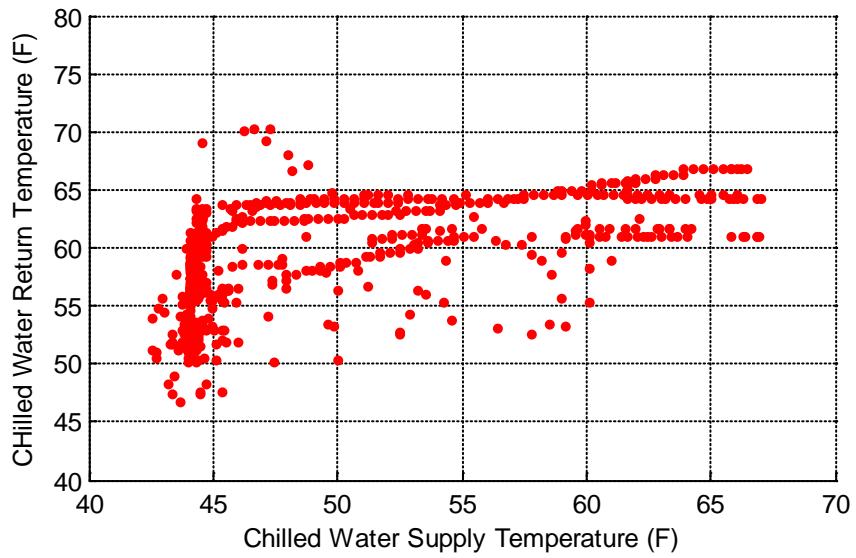

Figure 35 Drill Hall chilled water supply temperature vs. chilled water return temperature.

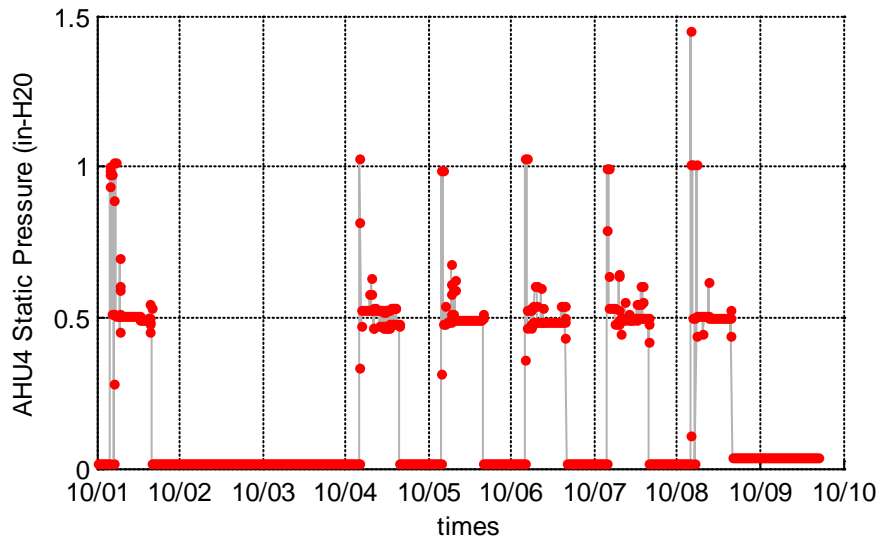

Figure 36 Drill Hall AHU 4 static pressure

## 6.0 PERFORMANCE ASSESSMENT

The performance of the automated continuous commissioning system has been assessed against the performance objectives listed in Table 1 in Section 3.0. Table 11 below summarizes the assessment for all the performance objectives. Details about how these objectives were achieved are presented in the following subsections.

**Table 11 Summary of performance assessment**

<b>Performance Objective</b>	<b>Success Criteria<sup>10</sup></b>	<b>Performance Assessment</b>
<b>Quantitative Performance Objectives</b>		
Reduce Building Energy Consumption (Energy) & Greenhouse Gas Emissions (CO <sub>2</sub> )	<p>&gt;10% reduction in building total energy consumption and related costs (over baseline)</p> <p>&gt;15% reduction in building peak demand energy and related costs (over baseline)</p> <p>&gt;10% reduction in building total equivalent CO<sub>2</sub> emissions (over baseline)</p>	<p>&gt; 30% reduction in building total energy consumption and related costs (over baseline)</p> <p>&gt;30% reduction in building peak demand energy and related costs (over baseline)</p> <p>&gt;30% reduction in building total equivalent CO<sub>2</sub> emissions (over baseline)</p>
Reduce HVAC Equipment Specific Energy Consumption (Energy)	>10% reduction in overall HVAC equipment specific energy consumption (over baseline)	> 20% reduction in overall HVAC equipment specific energy consumption (over baseline)
Reduce Building Loads (Energy)	5-10% reduction in lighting and plug loads and related costs (over baseline)	>20% reduction in lighting and plug loads and related costs (over baseline)
Building Model Validation	<p>Overall building energy consumption accuracy within +/- 15%</p> <p>HVAC equipment energy consumption accuracy within +/- 10%</p>	<p>Overall building energy consumption accuracy within +/- 10%</p> <p>HVAC equipment energy consumption accuracy within +/- 10%</p>
Automated Continuous	Simple payback time is less than 5	See the SPB, SIR calculation in

<sup>10</sup> Success criteria related to building and HVAC equipment energy consumption will be assessed using both model-based simulations and actual energy measurements. Note: only those recommended energy fault corrective actions that were implemented by DOD facilities during the execution of this project could be assessed using actual energy measurements.

Commissioning System Payback <sup>11</sup>	year <sup>12</sup> SIR is greater than 2.1.	section 7
<b>Qualitative Performance Objectives</b>		
Ease of Use	An energy manager and/or facility team skilled in HVAC able to do automated commissioning of building with some training	The user interface was refined based on feedback from facility team. The refined interface was well received.
Energy Fault Identification, Classification, and Prioritization	Energy manager and/or facility team able to detect , classify and prioritize (based on energy impact) building faults by comparing simulated building performance (design intent or optimal) against measured building performance	The system allows direct comparisons of energy consumption at multiple levels by providing deviations between the measurements and reference simulation models that either represent the design intent or have been calibrated to represent acceptable performance. Also, the system flags faulty behavior via anomaly scores. This information enables facility team to prioritize faults based on energy impacts from simulation models.
Water System Fault Identification, Classification and Prioritization	Energy manager and/or facility team able to detect , classify and prioritize building water system faults by comparing simulated building water consumption (design intent or optimal) against measured building water consumption	Water usage is not a primary concern to the demonstration sites.
Energy Fault Corrective Action Prioritization	Energy manager and/or facility team able to prioritize energy fault corrective actions by comparing the simulated building energy impact benefits for each fault corrective action alternative against the simulated or measured baseline building energy performance	By comparing the simulated building energy impact benefits, the system enables facility team to prioritize the fault corrective action.

<sup>11</sup> This payback success criterion is only applied to the case when the only retrofits considered are those that do not involve major equipment retrofits

<sup>12</sup> DoD Energy Managers Handbook <http://www.wbdg.org/ccb/DOD/DOD4/dodemhb.pdf>

Water System Fault Corrective Action Prioritization	Energy manager and/or facility team able to prioritize water consumption corrective actions by comparing the simulated building water consumption benefits for each fault corrective action alternative against the simulated or measured baseline building water consumption performance	Water usage is not a primary concern to the demonstration sites.
Automated Continuous Commissioning System Robustness	80% of faults identified are classified correctly (during 3 month demonstration period)	All faults that were detected and reported to the facility managers have been validated. Of the faults reported during the demonstration period, more than 80% have been identified and classified correctly based on feedback from the facility teams.

## 6.1 Building EnergyPlus Model

This section describes the calibration approach and results for Drill Hall EnergyPlus model

### Sensitivity analysis and calibration approach

A comprehensive sensitivity study was performed for the calibration of the Drill Hall EnergyPlus model to identify which parameters would influence the calibration process the most. The traditional input-output sensitivity analysis determines which parameter input influences uncertainty in the output the most. Depending on the range of uncertainty in each parameter, the number of input parameters and the required accuracy, numerous simulations are needed to determine the statistics. When choosing samples, there is a balance between computation time and accuracy, and there have been many methods developed to create samples as efficiently as possible. Instead of using the traditional Monte Carlo (MC) method, parameter samples were generated using the quasi-random sampling produced by the GoSUM software [22]. Derivative based sensitivities [23] are calculated for sensitivity analysis. Details about the approach can be found from the related publication [24].

Almost all numeric parameters in the EnergyPlus input IDF file were selected as uncertain, while a few of the parameters were chosen to be held constant in the analysis. Parameters that were not varied were architectural parameters (size, shape, and orientation of the building), as well as parameters related to equipment performance curve coefficients. The weather data were also not varied. The TMY3 (Typical Meteorological Year) data for Chicago, O'Hare airport were used for this sensitivity study. The nominal values for the parameters were chosen from

- as-built architectural, mechanical and control drawings (e.g., thermal properties of envelope and windows);
- actual building operation (e.g., lighting and AHU operation schedules); and
- manufacturers' catalog data (e.g., chiller coefficient of performance (COP)).

The resulting 1009 parameters were varied  $\pm 20\%$  of their nominal value. For nonzero parameters, a uniform distribution was imposed, while for parameters with zero nominal value (and which are constrained to be positive), an exponential distribution was used to keep the mean of the sampled values closer to nominal. Many of the parameters were constrained; for instance, fractional parameters with a nominal value of 0.9 would be varied between 0.72 and 1.0. The heating and cooling set-points had to be limited to 6.5% variation because otherwise they would overlap, which created conflict in the dual set-point management. All parameters were varied concurrently using a quasi-random approach. In this way, 5000 model realizations were created, which were ultimately parallelized and simulated on a 184 CPU Linux cluster.

From the numerous outputs that were available, 10 different outputs were chosen for analysis as listed in Table 12. These outputs are related to building energy consumption, including electricity and steam (i.e. district heating) from the facility level, to subsystems such as pumps, fans, equipment, and lights. These outputs were chosen because the profiles of these outputs reflect the Drill Hall building performance and energy end-use patterns. Two metrics used in this study were 1) annual total energy consumption, and 2) peak demand from electricity and district heating (hourly peak in one year).

**Table 12 Consumption Outputs Chosen for the Sensitivity Analysis**

Number	Name
1	DistrictHeating:Domestic Hot Water Energy [J]
2	DistrictHeating:HVAC [J]
3	Electricity:Facility [J]
4	DistrictHeating:Facility [J]
5	InteriorEquipment:Electricity [J]
6	InteriorLights:Electricity [J]
7	Cooling:Electricity [J]
8	Pumps:Electricity [J]
9	Fans:Electricity [J]
10	Chillers:EnergyTransfer [J]

Figure 37 shows the sensitivity indices of facility electricity consumption (annual total and peak demand) to the 1009 parameters. The top three input parameters, which influence the facility annual total electricity consumption most, are 1) the supply air temperature set-point for the AHUs serving the drill deck, 2) the chiller reference COP and 3) the drill deck lighting schedule. The top three input parameters with significant impact on facility electricity peak demand are 1) the chiller optimum part load ratio, 2) the chiller reference COP and 3) the supply air temperature set-point. The sensitivity study [21] showed that the parameters listed in Table 13 influence the facility electricity and facility district heating consumption the most.



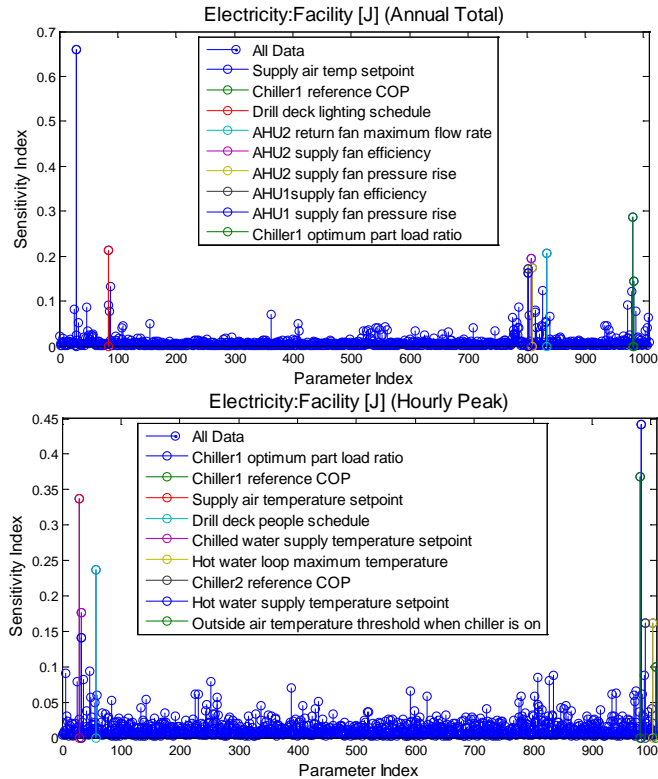

Figure 37 Sensitivity indices of facility electricity to 1009 input parameters

**Table 13 Some Selected Parameters from Sensitivity Study**

Parameters	Actual Values Used in the Calibrated Model
Hot water loop maximum temperature	212°F (100°C)
Outside air temperature threshold when chiller is on	58°F (14.4°C),
Chiller reference COP	3.0
Chilled water supply temperature set-point	44°F (6.7°C)
Minimal outside air fraction	AHU1 and AHU2: 32%; AHU3:49%; AHU4: 20%
AHU1/2 supply air temperature set-point	April 15 to October 14: 59°F (15°C) October 15 to April 14: 77°F (25°C)
AHU1/2 supply fan efficiency	0.6
Rated pump power consumption	Secondary chilled water pump:11190 W Hot water pump:5595W Primary chilled water pump:4476W
Ground surface temperature	EnergyPlus slab program was used to calculate
People schedule (fraction of number of people)	Based on information collected from site visit and conversation with facility manager
Lighting load and schedule	Calibrated with actual measured data from sub-meter
Zone cooling set-point	Occupied :76°F (24.4°C); unoccupied.86°F (30°C)
Zone heating set-point	Occupied 70°F (21.1°C); unoccupied.59°F (15°C)

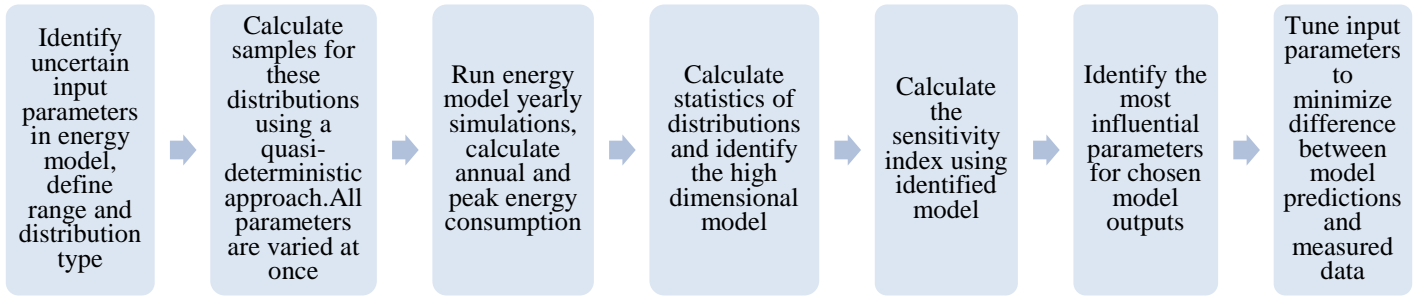
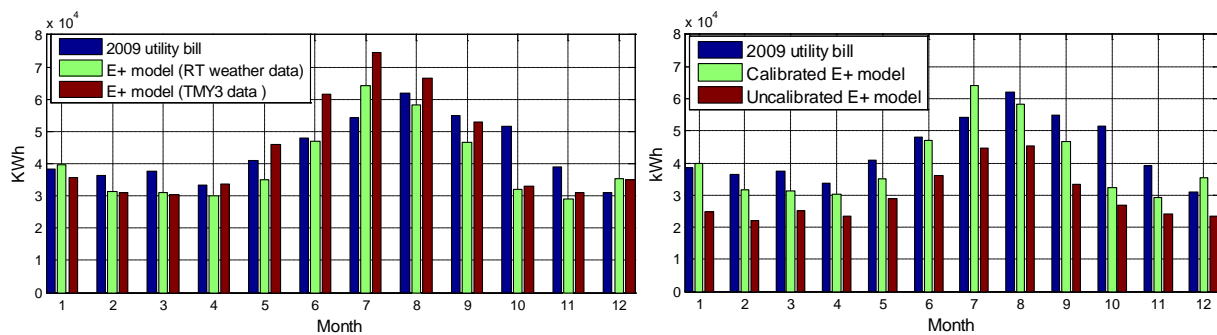

Figure 38 Calibration procedure

After the most influential parameters were identified, the final input values of these parameters to the model were chosen to minimize the difference between the model prediction (e.g., electricity consumption) and actual measured data based on: 1) actual operation sequence taken from EMCS; 2) actual measurements and observation from site visit; and 3) as built architectural, mechanical and control drawings. Figure 38 illustrates the calibration procedure used in this study.

### Calibration results

Figure 39a shows the calibration results from the proposed approach for the Drill Hall EnergyPlus model. In the parametric sensitivity analysis presented in this study, weather data were not changed. We ran the simulation with two different sets of weather data: 1) TMY3 weather data and 2) partial real time (RT) weather data (e.g., dry bulb temperature, dew point temperature, wind speed and direction etc.) from local Waukegan airport (about 7 miles north of the Drill Hall) for the year of 2009, which was downloaded from the DOE website. Whenever real time weather data are not available from this airport (e.g., solar radiation data for the whole year), data from TMY3 file is used. Only for the months of January, April, May, June, August and September, real time weather data are available from the Waukegan airport weather station. For these months, compared with 2009 utility bill, the predicted monthly electricity consumption from our calibrated EnergyPlus model with 2009 real time weather data are within  $\pm 10\%$  of measured values. The prediction errors from the uncalibrated EnergyPlus model for these months with partial real time weather data are in the range of 25% to 40% (Figure 39b). Since utility steam bill data are corrupted for the winter of 2009 (faulty condensate water meter), calibration study presented in this paper is restricted to electricity consumption.



(a) 2009 utility bill vs. calibrated EnergyPlus model (b) Calibrated model vs. uncalibrated model

Figure 39 Comparisons of monthly electricity consumption

An extensive performance monitoring system including an on-site weather station was installed in the Drill Hall in May 2010. Table 14 shows the comparison for selected end use electricity consumption from July 1st to July 26th, 2010. The total predicted electricity consumption from EnergyPlus model is only 3.56% higher than the actual metered data. This EnergyPlus model was driven by on-site real time weather data including solar radiation. The pyranometer is able to directly measure both diffuse horizontal radiation and global horizontal radiation.

**Table 14 Real time (July 1<sup>st</sup> to July 26<sup>th</sup>, 2010) comparison of end use electricity consumption**

Electricity Consumption (KWh)	Chillers	Plug load	Lighting load	AHU1 supply fan	AHU4 supply fan	AHU4 return fan
EnergyPlus	26387.51	2540.56	14762.68	1827.77	266.58	168.93
Measurement	23104.86	2627.76	14836.50	1679.27	279.10	163.15
Difference	14.21%	-3.32%	-0.50%	8.8%	-4.49%	3.54%

Figure 40 shows the power comparison for chiller and AHU1 supply fan between EnergyPlus model prediction and actual measured data from July 19th to July 26th, 2010. The large difference in AHU1 supply fan power consumption on July 26th is because the AHU1 fan was turned on in the model but turned off in reality.

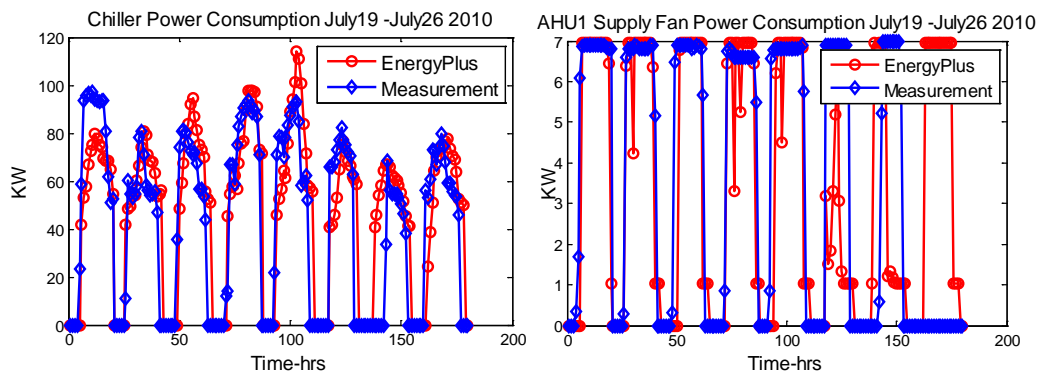

Figure 40 Comparisons of power consumption for chiller and AHU1 supply fan

The calibration results for BLDG 26 EnergyPlus can be found from Appendix E.

## 6.2 Energy Diagnostics

### Building 7230 (Drill Hall) Diagnostics

The proposed energy diagnostic tool was installed in the drill hall in April 2010. The facility was well maintained and so many things were done correctly from an energy perspective. However, the tool did identify a series of efficiency measures that include changes to the lighting and the controls and other further optimizations in the Drill Hall. Currently, anomaly scores and thresholds are computed by analyzing data from the previous 30 days. Data used for analysis comes from a 30-day sliding window and thus the thresholds can vary with time.

#### *Potential sensor bias*

Figure 41 shows an anomaly in an AHU as displayed in the visualization dashboard (discussed in the next section). The biggest contribution to this anomaly comes from a difference between the simulated and measured air temperature exiting the heating coil. The anomaly corresponds to

potential sensor bias for the temperature sensor located right after heating coil. It was confirmed with other data analysis that this temperature sensor was drifting.

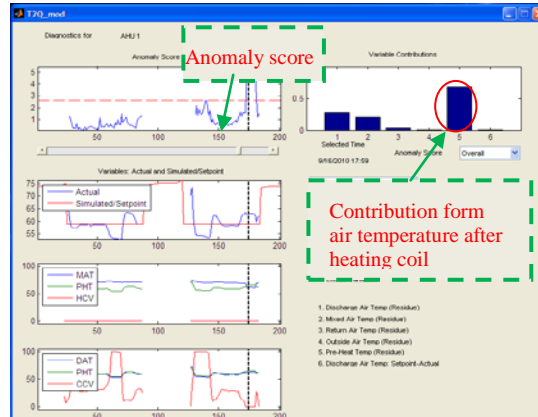

Figure 41 Potential sensor bias diagnostics

### Economizer fault

The upper plot in Figure 42 compares the outside air fraction for an AHU on May 4th, 2010 in the actual operation with that calculated from the reference EnergyPlus model. The anomaly scores (blue line) based on T2 statistics are plotted in the lower part. Whenever the anomaly score is above the threshold (red dash line), a potential fault is indicated. Since only one variable (outside air fraction) was used to compute the anomaly score, there is no contribution weights plot. In non-economizer mode, the flow rate of outside air is up to ~50% of total supply airflow rate, which is ~8,000 CFM (3.775 m<sup>3</sup>/s). According to the design intent, the building needs ~6,000 CFM (2.831 m<sup>3</sup>/s) to make up the exhaust and ensure a slightly positive building pressure. Therefore, there is a potential to further reduce the outside air intake in non-economizer mode, which will save both cooling and heating energy. The annual steam consumption in heating season will be reduced by about 40% based on the prediction of the reference EnergyPlus model.

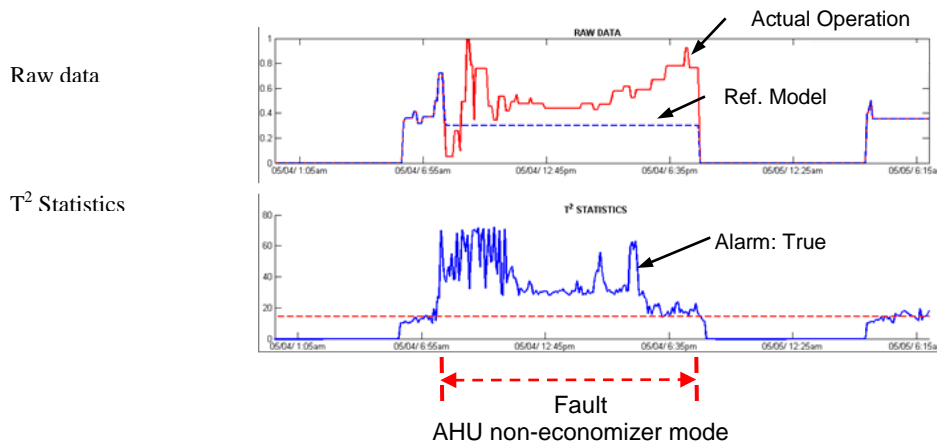

Figure 42 Economizer fault

### Lighting fault

Figure 43 shows the identified faults due to lights on during unoccupied hours from November 1<sup>st</sup> to November 15<sup>th</sup>, 2010. Lighting submetering data from June 2010 was used as training data. The top plot shows the anomaly score. The middle plot shows the actual lighting electricity consumption. The periods marked with red line correspond to the hour when the lights are on during unoccupied hours. The periods that the lights were off when they were supposed to be on is marked with green line.

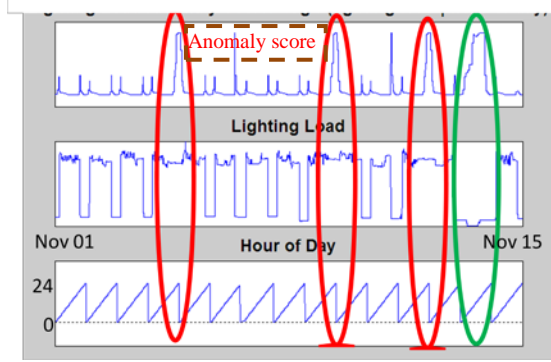

Figure 43 Lighting faults

Comparison of the total building electricity consumption using the tool shows discrepancies between the measured and estimated values, as shown in Figure 44. Comparison of the end uses shows differences in the chiller power consumption and lighting.

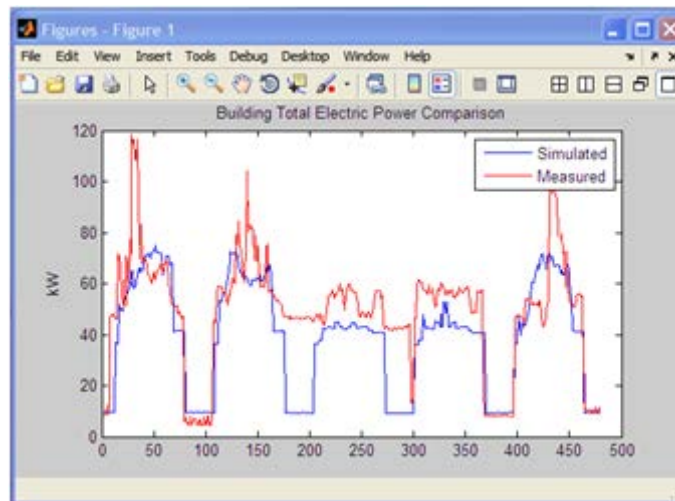

Figure 44 Comparison of the total building electricity consumption between measured and simulated data for one week

A comparison of cooling and lighting electricity uses is displayed in Figure 45. On further analysis of the difference in cooling electricity use, it was found that differences arose when the model used free cooling while active cooling was used in the building. This missed opportunity for free cooling amounted to 5.3% potential energy savings at the building level for that week. Similarly, the difference in lighting energy consumption occurs during nights when the model predicts minimal lighting consumption. Lights were left on overnight in these cases as shown in the figure and the potential for energy savings at the building level was 8.5% for that week.

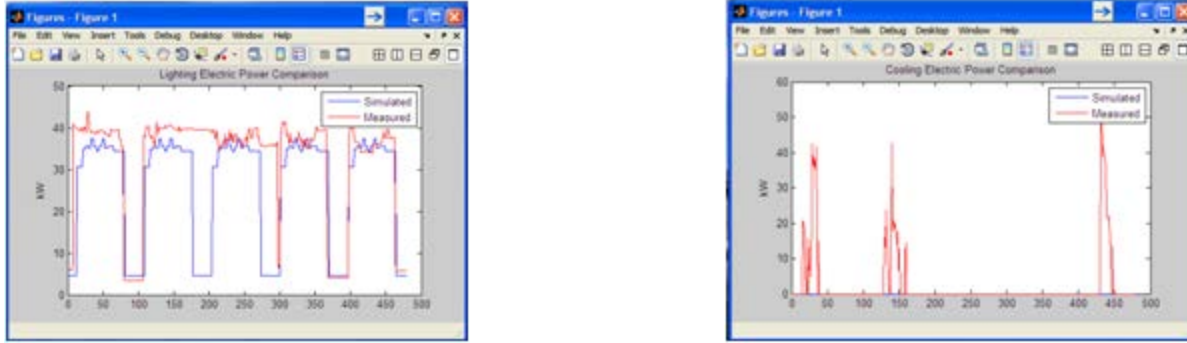

Figure 45 Comparison of lighting power consumption (left) and cooling electricity power consumption (right) for one week

### Building 26 Diagnostics

The performance monitoring and visualization tool was commissioned in August 2011 at Building 26 and is currently in operation at the site. The data had been collected since April 2011 and analysis was performed offline for data collected prior to August 2011.

Another kind of discrepancy was also found in cooling energy consumption. As shown in Figure 46, the model predicted non-zero energy consumption whereas the data shows no energy consumption from the chiller. On further analysis, it was found that there was a chiller control problem such that the chiller stayed off while it was commanded to be turned on. In the case of this fault, the AHU call-for-cooling status is on as well and there is an impact on occupancy comfort as the zone temperature is not maintained.

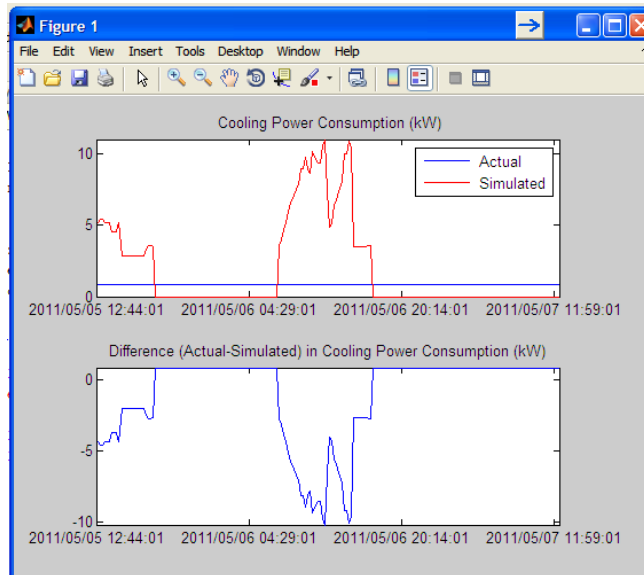

Figure 46 Comparison of cooling electricity power consumption for the period beginning 05-May-2011 and ending 07-May-2011

Similarly, the model disagreed with the plug-load measurements. The model expects minimal energy consumption because of plug-loads after work hours whereas this is not evident from the measured data as shown in Figure 47. This excessive plug load consumption was confirmed with

the facility team to be a result of occupant behavior. Figure 49 shows the actual plug load profiles from Building 26 compared with the proposed plug load profiles from ASHRAE 90.1-2004 [21]. The occupants' behavior (e.g., leaving computers on overnight, use of personal heaters) has a significant impact on the energy consumption.

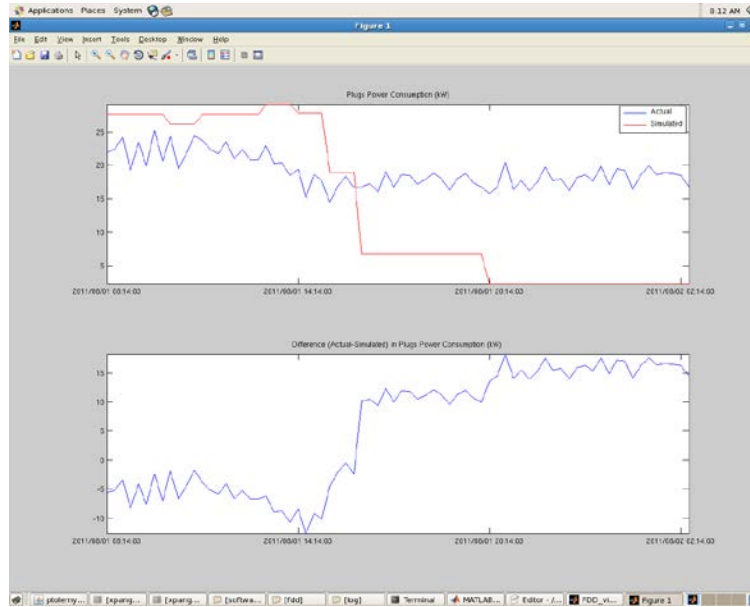
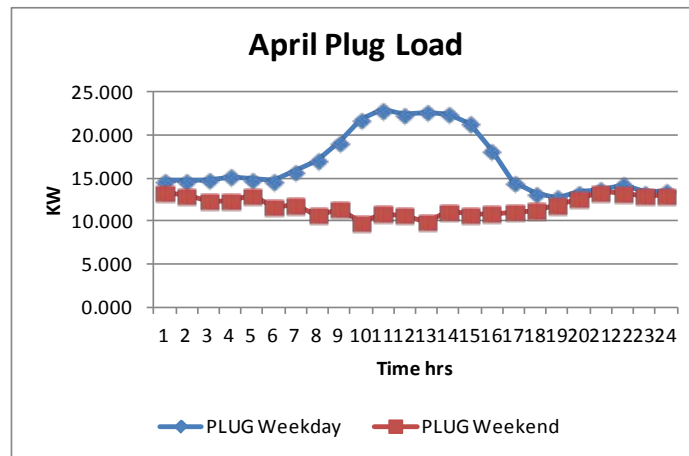

Figure 47 Comparison of plug-loads for 01-Aug-2011 from 8:00 AM to midnight.



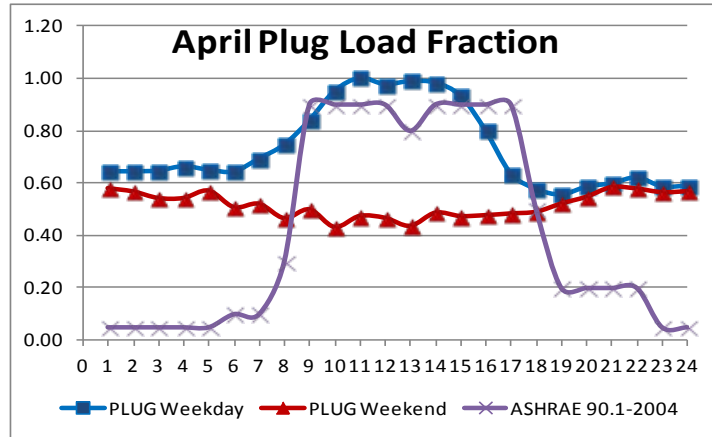

Figure 48 April plug load profiles in Building 26

### 6.3 Energy Savings Assessment

The purpose of this subsection is to address the potential energy savings identified by assessment of building performance in the project. In summary, the research team was very impressed with the facility and that so many things were done correctly from an energy perspective. However, the team has a set of suggested improvements that include changes to lighting and to controls, together with other efficiency measures. Table 2 in section 3 summarizes the suggested energy savings strategies, associated savings and simple payback time.

#### Overall Review of Electricity Consumption

Real time data measured during the week from May 4 to May 11 are used to demonstrate energy end uses in the Drill hall. Due to the extensive submetering system, it was possible to monitor electricity consumption by different subsystems and components. Table 15 and Figure 49 show electricity end use break down for this week. Lighting system electricity consumption is about 61% of total, followed by AHU fan consumption and by chiller electricity consumption.

**Table 15 Total electricity consumption from May 4 to May 11, 2010**

	Plug	Chiller1	Chiller2	Lighting	AHU fans	Pumps	Others*	main
kWh	818.89	828.10	0.00	5102.24	1371.61	174.86	58.84	8354.54
Percentage	9.80%	9.91%	0.00%	61.07%	16.42%	2.09%	0.70%	

\* includes one primary chilled water pump, 2 exhaust fans (EF2, EF3) and plugs load in mechanical room



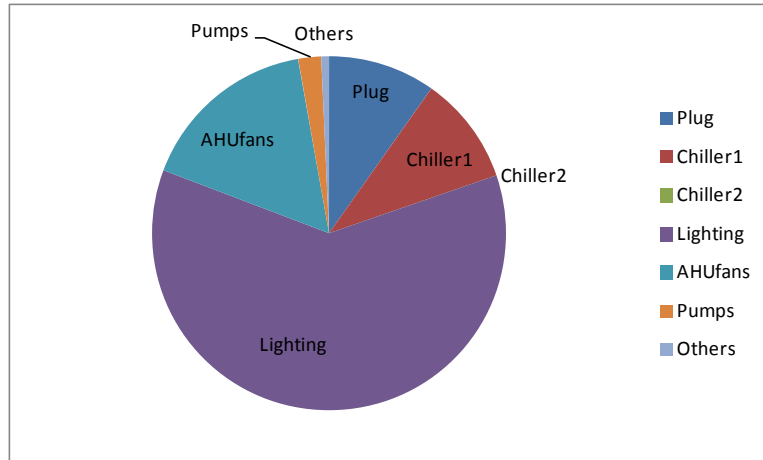

Figure 49 Total electricity consumption end use breakdown from May 4 to May 11, 2010

### Energy Savings Assessment

In this section, a few potential energy savings opportunities are indentified. Energy impacts based on model predictions are presented. The Drill Hall EnergyPlus model with TMY3 weather data is used as the energy modeling platform.

We also have identified some other small energy savings opportunities such as chilled water/hot water differential pressure reset. Since the savings are small, they will not be addressed further in this document. In this document, the following potential energy savings opportunities are addressed:

- Lightings system
- AHU1/2 OA intake in the non-economizer mode
- AHU1/2 operation mode

#### 1) Lighting System in Drill Hall

##### Current operation:

The real time data (Figure 50) shows the Drill Hall lighting demand (kW, 5-minute sampling frequency) from May 4 to May 11, 2010. The lighting demand is dominated by the drill deck lights. 64 regular 400W lamps (total 25.6 kW) in the drill deck are turned on from 5:30am till 10:00pm every day. Currently, there are no lighting controls in the building. During site visits by research team members, it was observed that most of time there were no activities in the Drill Deck, while all the lights were on.

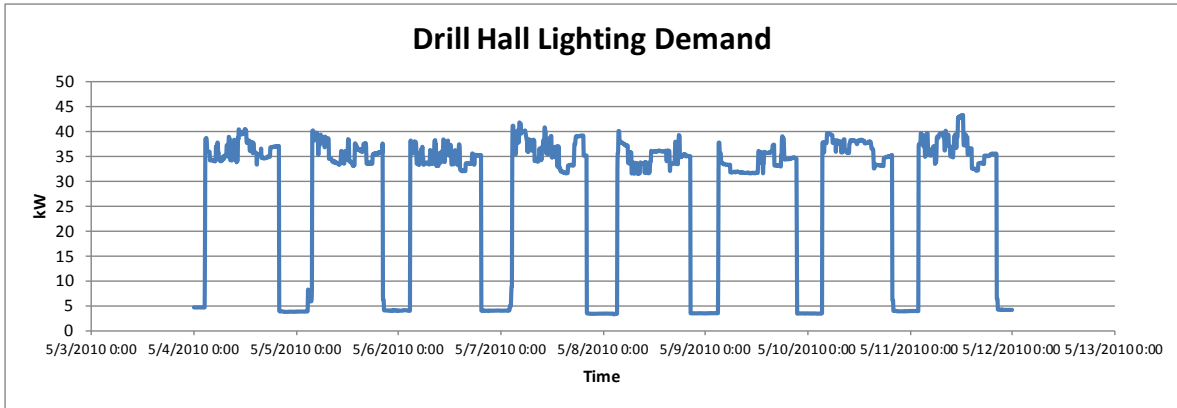

Figure 50 Drill Hall lighting demand from May 4 to May 11, 2010

Figure 43 and Figure 45 also show lighting schedule issues (lights on during night) in Drill Hall.

Recommendation:

- 1) Replace the regular lamps (metal halide-MH) with T5 high output fixtures for improved energy efficiency, lumen maintenance and color rendering index. 400W metal halide fixtures require about 465 input Watts. Replacing a MH fixture with a T5 HO fixture using only 234 input Watts will reduce power by 231 Watts per fixture, about 50% savings.
- 2) Occupancy based lighting control. Install occupancy sensors that will shut lights off when no motion is detected in the Drill Deck.
- 3) Daylighting control. Currently, the motorized blinds are decoupled from the lighting system. The lights could be dimmed or turned off when there is enough daylighting. This probably will require installation of additional photocell sensors.

Energy Savings:

The EnergyPlus model of the design intent was used for current operation, where the lights (64 x 400W) in the drill deck are turned on from 5:30am to 10:30pm every day. A proposed operation (Case 1) with the assumption that lights in the drill hall will be turned off 50% of the current operation time (5:30am to 10:00pm everyday) is simulated in the EnergyPlus model.

**Table 16 Annual energy (electricity) end use break down comparisons between current operation and proposed operation (occupancy based lighting control)**

kWh*1000	Interior Equipment	Interior Lights	Cooling	Pumps	Fans	Facility
Current Operation	38.90	227.90	67.33	31.08	44.49	409.70
Proposed Operation	38.90	139.54	63.74	31.24	41.47	314.89
Difference (%)		<b>-38.77%</b>	-5.33%	0.50%	-6.79%	<b>-23.14%</b>

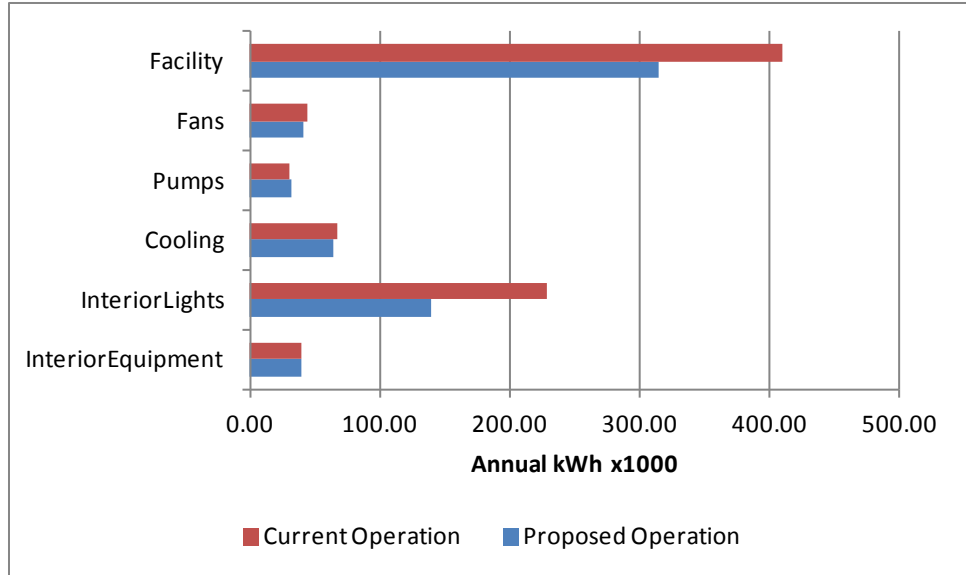

Figure 51 Annual energy (electricity) end use breakdown comparisons between current operation and proposed operation (occupancy based lighting control)

Table 16 and Figure 51 show that annual energy end use break down comparisons of current operation and proposed operation (occupancy based lighting control). There are significant lighting savings due to fewer operated hours for lights in the drill deck. Due to lower internal heat gains, cooling (chillers) and fans energy consumption become less too. Total electricity savings of **23.14%** could be achieved through this simple light-reschedule. In the winter, the steam consumption is only increased by 2.3% due to less internal heat gains from lights. Figure 52 below shows the monthly break down for total electricity consumption in the drill hall for both cases.

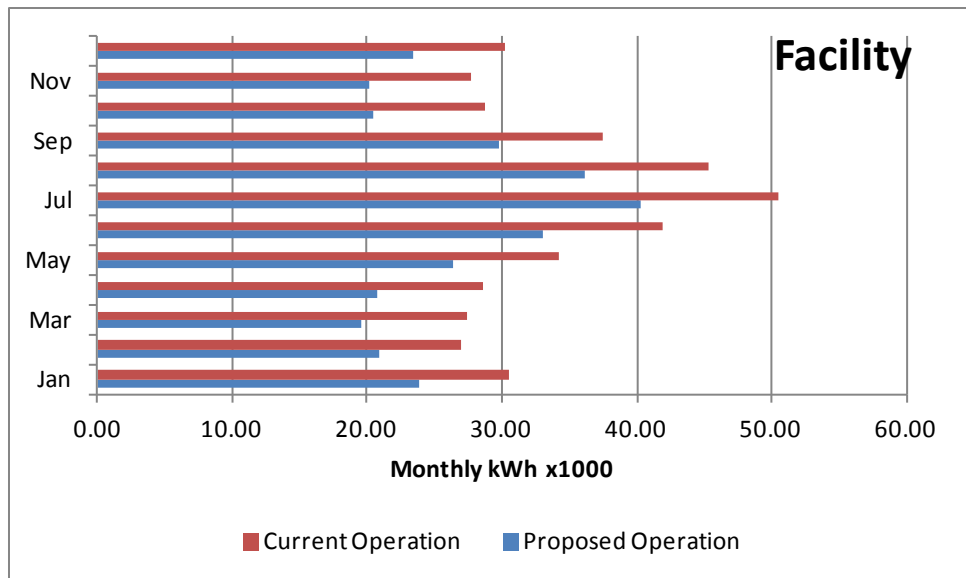

Figure 52 Total electricity consumption monthly breakdown comparisons between current operation and proposed operation (occupancy based lighting control)

Simple Payback:

Assuming \$0.069 per kWh for the electricity and an initial cost of \$1000 to install the occupancy sensors, turning off lights 50% of current operation time will result in \$6,542 annual savings with a simple payback period of less than two months.

**2) Excessive AHU1/2 Minimum Outside Air (OA) Intake in Drill Hall**

Current operation:

As shown in Figures 53, 54 below, in non-economizer mode, the flow rate of outside air is up to ~50% of the total supply air flow rate, which is ~8,000 CFM. According to the design documents, the building needs ~6,000 CFM to make up the exhaust and also ensure slight positive pressure in the building. Therefore, there is the potential to reduce the flow rate of outside air in non-economizer mode, which will save both cooling and heating energy.

Figure 42 shows the anomaly score based T<sup>2</sup> statistics for this OA intake issue.

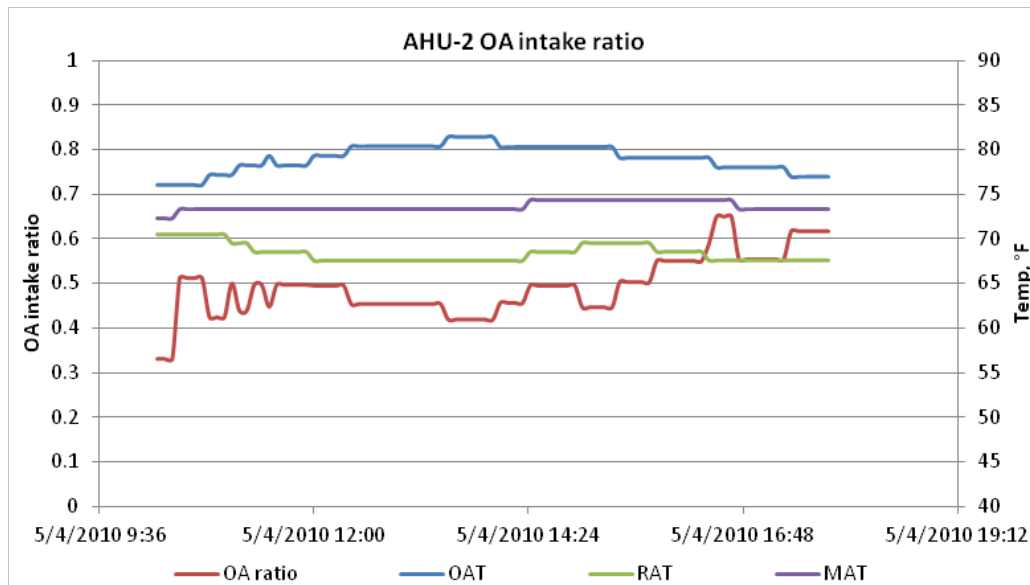

Figure 53 AHU2 operation temperatures with OA intake ratio (MAT-RAT/OAT-RAT)

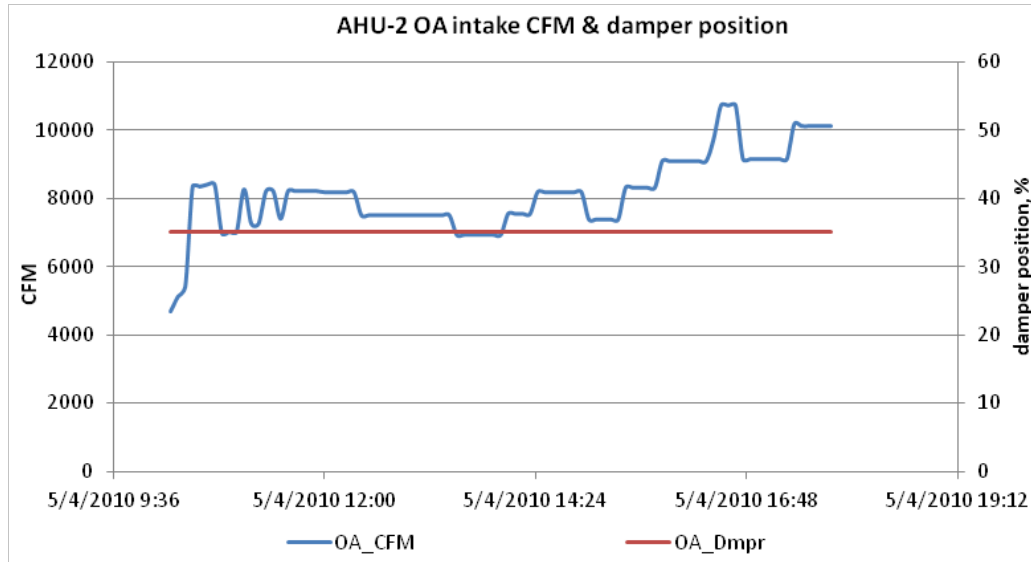

Figure 54 AHU2 outside air (OA) damper position and outside air flow rate

**Recommendation:**

Reduce the outside air flow rate for AHU 1 & 2 in the non-economizer mode by adjusting the minimum outside air damper position.

**Energy Savings:**

The EnergyPlus model of design intent is used to calculate the energy consumption from the proposed operation, where the outside air flow rate is set to be 6,000CFM (outside air flow fraction is about 30%). Case 2 with the current operation of AHU 1 & 2 (outside air flow fraction ~0.5) was also simulated.

**Table 17 Annual energy (electricity and steam) end use break down comparisons between current operation and proposed operation (reduce OA intake in non-economizer mode)**

kWh*1000	Interior Equipment	Interior Lights	Cooling	Pumps	Fans	Facility
Current Operation	38.90	227.90	70.11	32.40	45.57	414.88
Proposed Operation	38.90	227.90	67.33	31.08	44.49	409.70
Difference (%)			-4.13%	-4.24%	-2.43%	-1.27%

MMBTU	Heating
Current Operation	1761.83
Proposed Operation	1254.03
Difference (%)	<b>-40.49%</b>

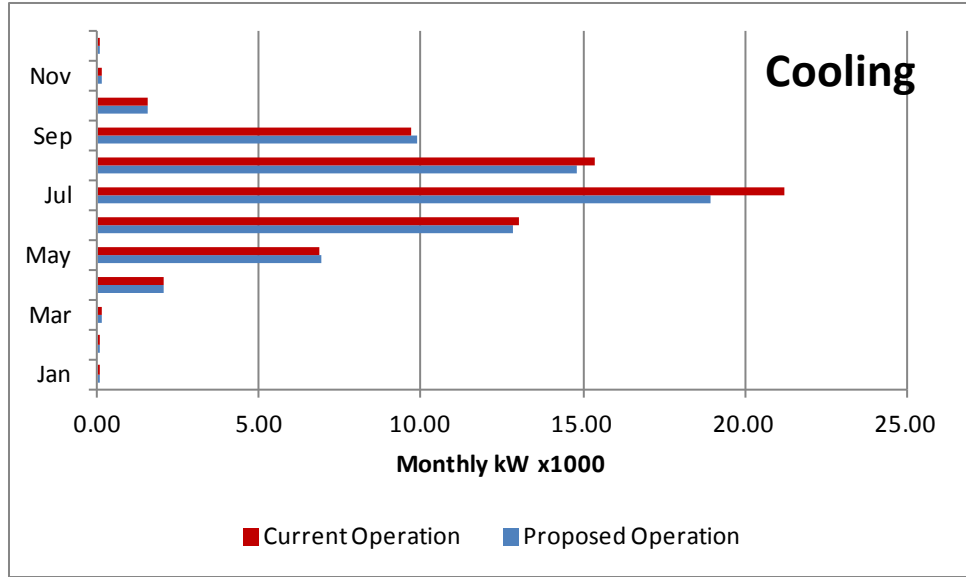

Figure 55 Monthly comparison of cooling electricity consumption between current operation and proposed operation (reduce OA intake in non-economizer mode)

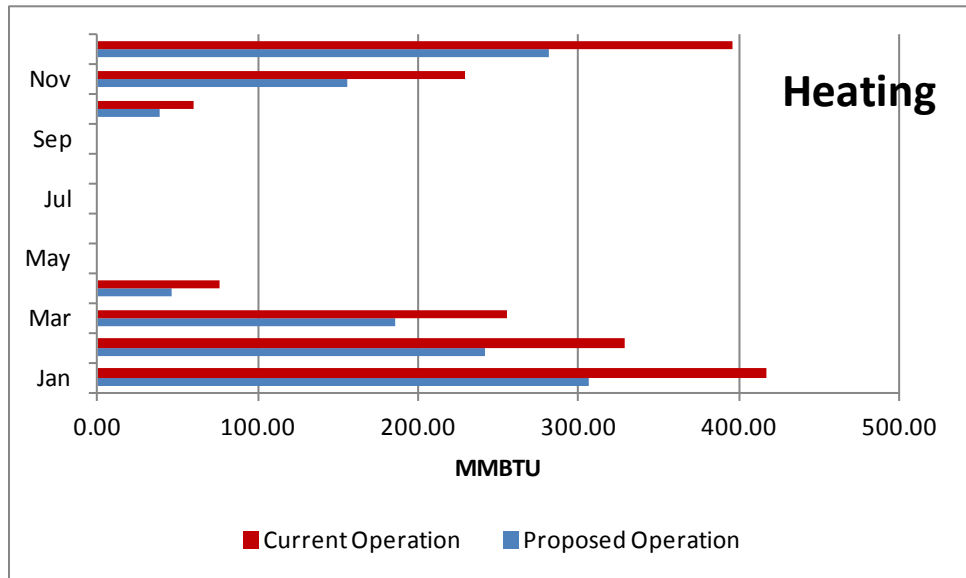

Figure 56 Monthly comparison of steam consumption between current operation and proposed operation (reduce OA intake in non-economizer mode)

Table 17 shows the annual energy end use break down comparisons between current operation and proposed operation (reduce OA intake in non-economizer mode). Figures 55 and 56 show the monthly break down for total cooling and heating consumptions in the drill hall for both cases. Considering that Great lake weather (cold winter and cool summer), there are significant heating savings (**40.49%**) if the outside air intake is reduced to the design intent. Actually, currently, the Drill Hall is not used as heavily as assumed in the design intent. It may, therefore, be possible to further reduce the OA fraction to, say, 20%.

Simple Payback:

Assuming \$8.7 per MMBTU for the steam and initial cost of \$500 to adjust some control parameters, decreasing the OA fraction from 0.5 to the design intent will result in \$4,418 annual savings and a simple payback period of less than one month.

**3) AHU-1 & 2 Operation Mode in Drill Hall**

Current operation:

Either AHU 1 or AHU 2 serves the entire drill deck as shown in Figure 57. The selection is made on a weekly basis. The fan speed is modulated between 35% and 83%.

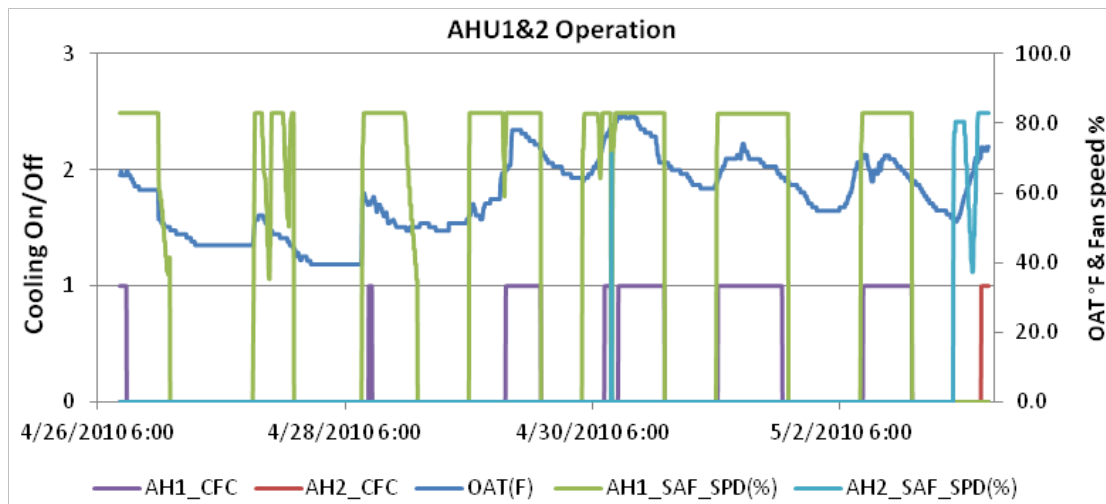

Figure 57 AHU 1 & 2 operations

Recommendation:

Run two units in parallel. The lead unit will still be selected on a weekly base. The lag unit will be enabled when the lead unit supply fan speed reaches 60% (adj.). The operation can be achieved by controlling damper D-4, D-5 and D-6 as shown in Figure 58.

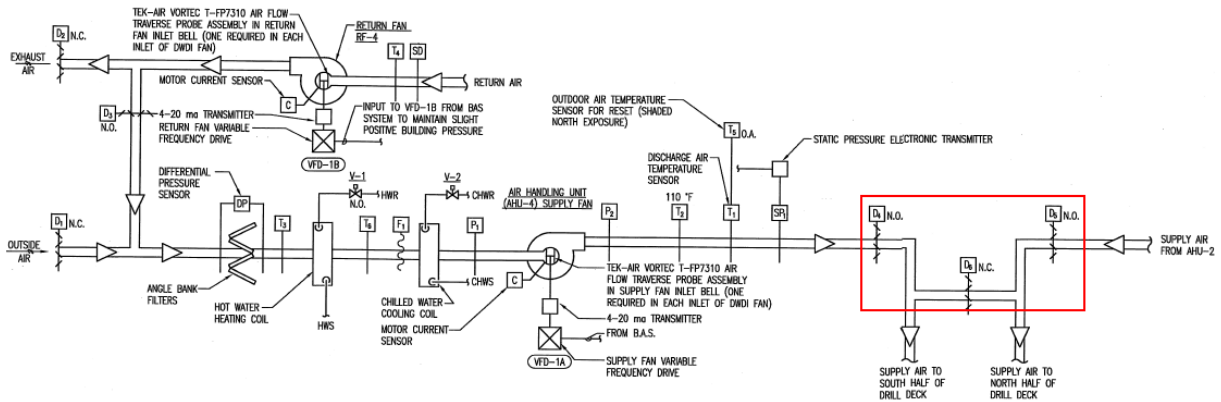

Figure 58 AHU1 schematic diagram

Energy Savings:

The EnergyPlus model of the current operation of AHU 1 and AHU 2 is used as the baseline, in which either AHU 1 or AHU 2 serves the entire drill deck. Case 3 with the proposed operation of AHU 1 and 2 (AHU1 will serve the south deck while AHU2 will serve the north deck) is simulated in EnergyPlus.

**Table 18 Annual energy (electricity) end use break-down comparisons between current operation and proposed operation (run two AHUs at the same time)**

kWh*1000	Interior Equipment	Interior Lights	Cooling	Pumps	Fans	Facility
Current Operation	38.90	227.90	67.33	31.08	44.49	409.70
Proposed Operation	38.90	227.90	69.61	34.25	30.61	401.271
Difference (%)			3.40%	10.19%	<b>-31.21%</b>	<b>-2.06%</b>

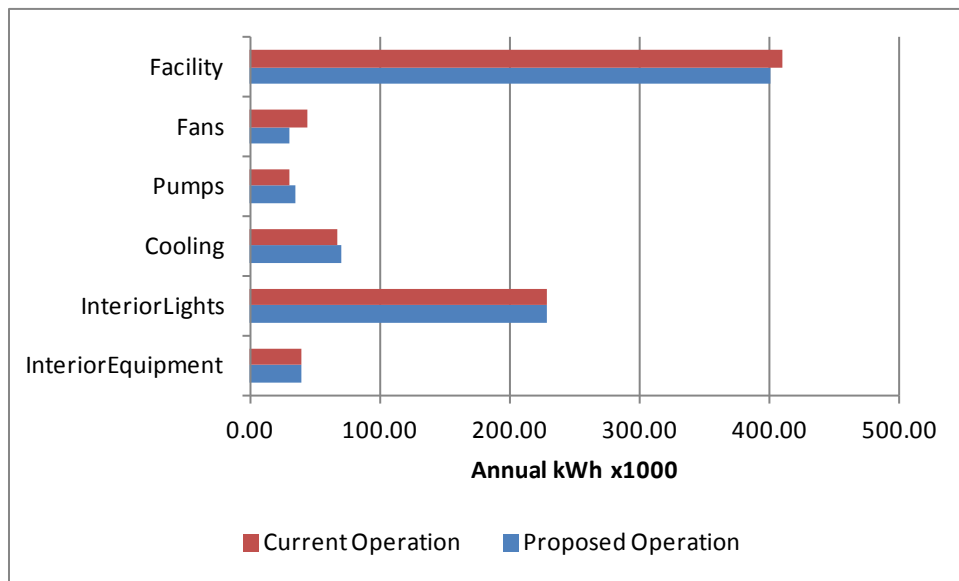

Figure 59 Annual energy (electricity) end use break-down comparisons between current operation and proposed operation (run two AHUs at the same time)



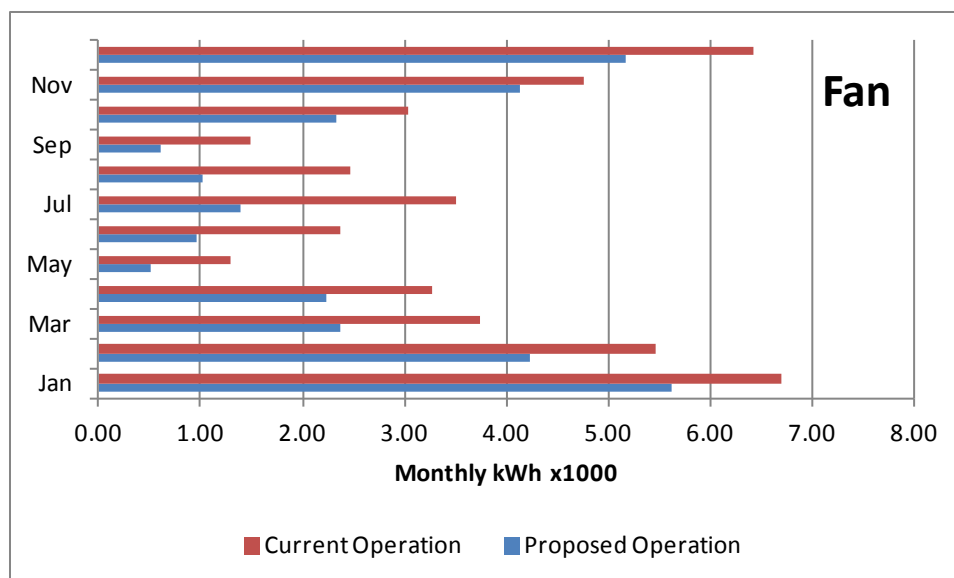

Figure 60 Fan electricity consumption monthly breakdown comparisons between current operation and proposed operation (run two AHUs at the same time)

Table 18 and Figure 59 show that annual energy (electricity) end use break down comparisons between current operation and proposed operation (run two AHUs at the same time). There are significant fan electricity (**31.21%**) savings due to less flow rates. However, fan energy consumption is only small portion of the total facility electricity consumption. Therefore, the total energy savings are relative small for this case. Figure 60 below shows the monthly break down for fan electricity consumption in the drill hall for both cases.

Simple Payback:

Assuming \$0.069 per kWh for the electricity, running two AHUs in parallel will result in \$582 annual savings. There is no initial cost to do this change since current system configuration is capable of being operated in this way.

**4) Plug Issue in Building 26**

Current operation:

The current plug load usage in Building 26 is plotted in Figure 61. Figure 49 shows the actual plug load profiles from Building 26 compared with the proposed plug load profiles from ASHRAE 90.1-2004 [21] The occupants' behavior (e.g., leaving computers on overnight, use of personal heaters) has a significant impact on the energy consumption.

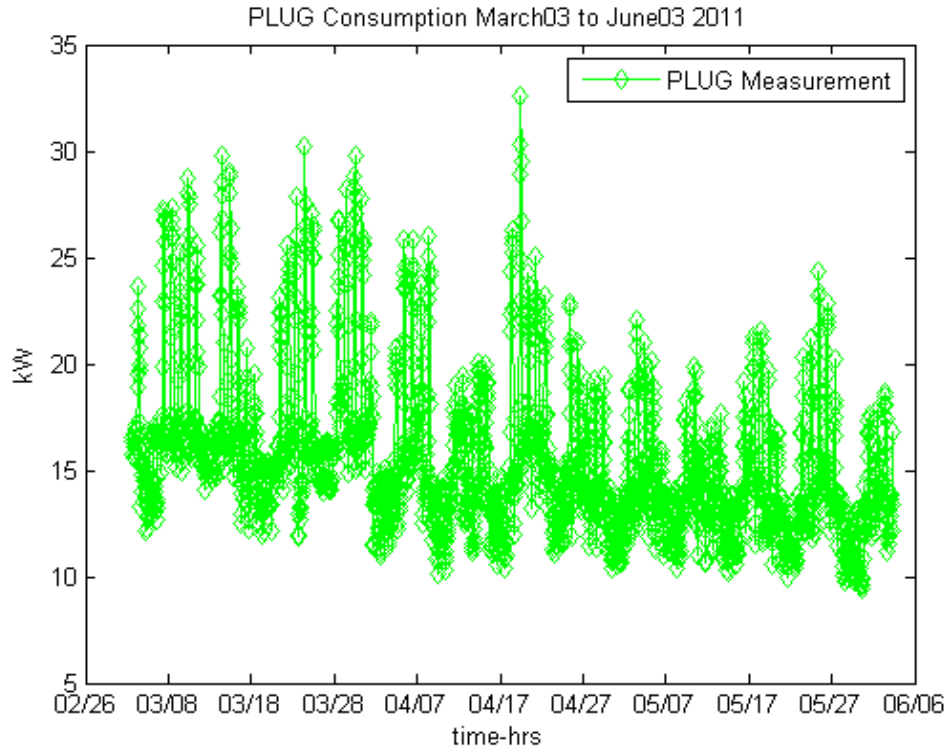

Figure 61 Plug electricity consumption in Building 26 from March 3rd to June 3rd 2011

Recommendation:

Better schedule computer, personal heater and other personal electrical equipment usage. Shut off the computer when people leave the office. The plug load power density is not changed while the usage fraction will be reduced significantly.

Energy Savings:

The EnergyPlus model with current operation of electrical equipment (plug loads) is used as the baseline, where plug load profiles are taken from real time measurement data as reflected in Figure 61. A proposed operation with the assumption that load profiles from ASHRAE Standard 90.1-2004 [21] (Figure 49) is simulated in the EnergyPlus too.

**Table 19 Annual energy (electricity) end use break down comparisons between current operation and proposed operation (plug load regulation)**

kWh*1000	Interior Equipment	Interior Lights	Cooling	Pumps	Fans	Facility
Current Operation	139.47	35.38	54.87	10.95	26.83	267.50
Proposed Operation	82.75	35.38	53.90	11.12	24.66	207.80
Difference (%)	<b>-40.67%</b>	0.00%	-1.78%	1.58%	-8.10%	<b>-22.32%</b>

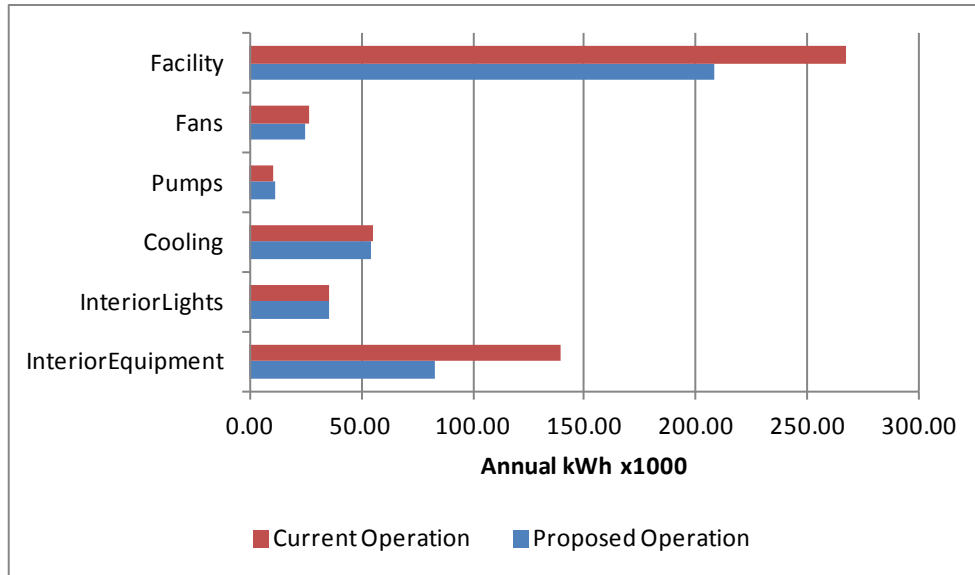

Figure 62 Annual energy (electricity) end use breakdown comparisons between current operation and proposed operation (plug load regulation)

Table 19 and Figure 62 show that annual energy end use break down comparisons current operation and proposed operation (plug load regulation). There are significant electricity savings due to less plug loads in the building. Due to less internal heat gains, cooling (chillers) and fans energy consumption become less too. Total electricity savings of **22.32%** could be achieved through this simple light-reschedule. In the winter, the steam consumption is only increased by 3.43% due to less internal heat gains from lights. Figure 63 below shows the monthly breakdown for total electricity consumption in Building26 for both cases.

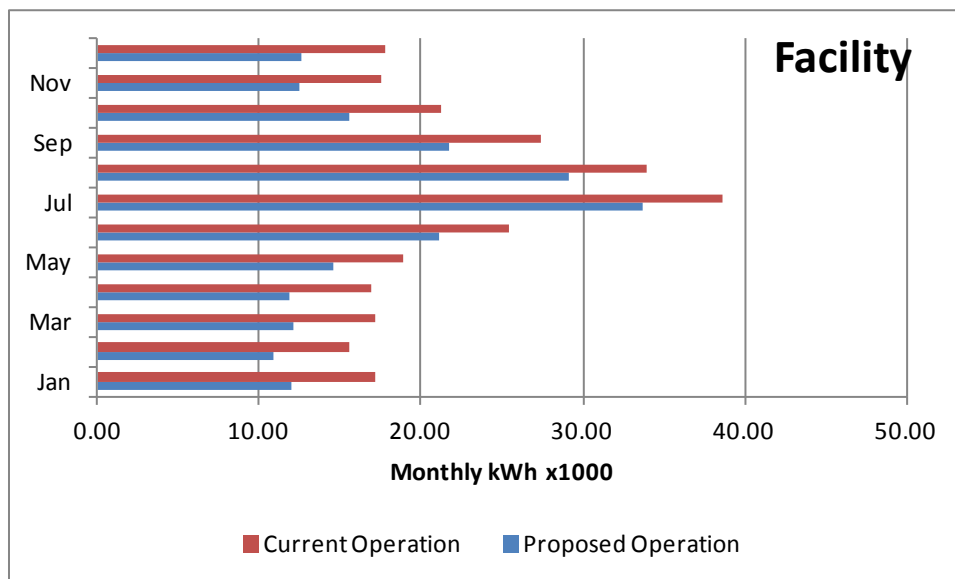

Figure 63 Total electricity consumption monthly break down comparisons between current operation and proposed operation (plug load regulation))

Simple Payback:

Assuming \$0.069 per kWh for the electricity and no initial cost, implementation of plug load regulation will result in \$4,119 annual savings. There is no initial cost to do this plug load regulation

## 7.0 COST ASSESSMENT

### 7.1 COST MODEL

A cost model for the automatic continuous commissioning tool is provided in Table 20. Since the demonstration served as a proof-of-concept, particular attention was given to the instrumentation selection so that the model output uncertainties that arise from the uncertainties of these measurements can be minimized. The high quality instrumentation used in the project is required only to validate results and deployment of this technology beyond the two demonstration sites could use less expensive instrumentation. It is expected that similar system performance could be achieved by using fewer sensors/meters as well as less expensive sensors. A detailed discussion is given in the following subsections.

Cost Element	Data Tracked During the Demonstration	Estimated Costs (\$)	
		Bldg 7230	Bldg 26
<b>Hardware capital costs</b>	Estimates made based on component costs for demonstration	41,055	49,123
<b>Installation costs</b>	Labor and material required to install	34,868	28,934
<b>Consumables</b>	Estimates based on rate of consumable use during the field demonstration	N/A	N/A
<b>Facility operational costs</b>	Reduction in energy required vs. baseline data	N/A	N/A
<b>Maintenance</b>	<ul style="list-style-type: none"> <li>• Frequency of required maintenance</li> <li>• Labor and material per maintenance action</li> </ul>	One day per year (\$1000)	One day per year (\$1000)
<b>Hardware lifetime</b>	Estimate based on components degradation during demonstration	0	0
<b>Operator training</b>	Estimate of training costs	One day (\$1000)	One day (\$1000)

<sup>1</sup> Detailed list of materials and analytical costs provided in Final Report

#### 7.1.1 Hardware Capital Costs

The hardware capital costs are mainly attributed to the additional instrumentation, which is required to provide run-time model inputs, calibrate models and do energy performance diagnosis. An EMCS with BACnet gateway is a requirement for implementing the technology. In cases where the BACnet gateway is absent and needs to be provided, additional cost is incurred. The measurements related to run-time weather inputs are outdoor dry bulb temperature,

outdoor relative humidity, direct normal solar radiation, diffuse solar radiation, wind speed and direction. The additional measurements required to track key performance metrics are electrical power submetering and thermal energy consumption for cooling and heating. The submetering of the electrical power should be able to measure the whole building electrical power and separate the lighting electrical power, plug load electrical power, key HVAC equipment (e.g. chiller) and total HVAC equipment electrical power.

The detailed breakdown costs for materials used for the demonstration are listed in Table 21 for Building 7230 and Table 22 for Building 26.

**Table 21 Material cost for Building 7230**

Items	Cost	Percentage
BACnet server	\$5,400	13%
Siemens expansion board enclosure	\$1,954	5%
4 DEM (digital energy monitor)	\$4,950	12%
2 BTU meters	\$9,471	23%
2 sensors for primary CHW	\$394	1%
PC	\$3,706	9%
Weather station	\$15,180	37%
Total	\$41,055	

**Table 22 Material cost for Building 26**

Items	Cost	Percentage
BACnet server	\$5,400	11%
Siemens expansion board enclosure	\$977	2%
Siemens Insight software	\$5,022	10%
7 DEM (digital energy monitor)	\$9,104	19%
2 BTU meters	\$9,594	20%
PC for insight	\$1,168	2%
PC	\$3,706	8%
Weather station	\$14,152	29%
Total	\$49,123	

The highest cost item for both sites is the weather station. Table 23 provides a breakdown of the costs for the weather station. The wind speed and direction sensor is more expensive for building 7230 because this sensor was purchased through the installer and the price reflects fees and overhead from this installer. The team noticed this and provided the sensor to the installer directly for the second demonstration site.

**Table 23 Material cost for weather station**

Items	Building 7230	Building 26
Pyranometer	\$11,130	\$11,130
Outside air dry bulb/RH	\$1,200	\$1,200
Weather station aspirated housing	\$622	\$622
Wind speed and direction	\$2,229	\$1,200

## **Additional Weather Station**

Pyranometer: Pyranometers are not typically used in the building industry and most of the pyranometers available on the market only measure the global (total) solar radiation. However, separation of the global solar radiation into the direct beam and the diffuse solar components is required to simulate the building performance properly in the whole building simulation program. The chosen pyranometer was the only off-the-shelf product that can measure the total solar radiation and diffuse solar radiation when the project started. A newly available product has no moving parts and is more compact compared to the chosen pyranometer with about half of the cost. However, this product only outputs global solar radiation and diffuse solar radiation and the user has to derive the beam solar radiation from these two measurements. Nevertheless, this product has the potential to reduce the major component of the cost of the weather station.

Temperature and relative humidity sensor: Outside air temperature and humidity are weather variables with the most influence on the performance of typical commercial buildings. Modern buildings equipped with an EMCS commonly have the outdoor dry bulb temperature and relative humidity measurements available. They can be used directly by the technology. However, care needs to be taken to ensure that existing sensors are calibrated and properly located to provide reasonable measurements.

Wind speed and direction sensor: The wind speed and direction will affect the building external convective heat transfer coefficient as well as the infiltration rate and will impact the building energy performance. Most available products on the market should satisfy this need for the technology implementation.

Real time weather data from an on-site weather station, including solar radiation data, are essential to reduce model prediction error. Statistical TMY3 weather data can cause the model predictions to significantly deviate from measured data. For the July 2010, the average difference between measured outside air temperature and TMY3 data is about 5.4°F (3°C), and maximum difference is about 235°F (12.75°C).

When deploying the technology, there are a few options that can be considered for cost reduction:

- 1) If internet access is available, we will choose to use the data from the NOAA website (National Oceanic and Atmospheric Administration) directly without installing the weather station. If the internet access is not available, as is the case at Naval Station Great Lakes, then a weather station has to be installed. Using real time weather data is very important for any building simulation program used in this application.
- 2) Multiple buildings on one campus will be able to share one weather station with the necessary network setup. It is possible that this kind of network setup (e.g. centralized BMS) is not available for some campuses.

## **Additional Submetering**

The cost associated with the submetering is very site-specific and presents the highest variability. The number of electric power meters needed to disaggregate the end-uses can be as few as four or greater than ten. The number of electric power meters needs be determined by reviewing the electrical as-built drawings and through an on-site investigation.

The instrumentation for the thermal energy measurement needs to be determined on a site-by-site basis, e.g. electromagnetic vs. turbine flow meter, hot water measurement vs. steam

measurement. If long straight pipe sections are available, a more cost effective turbine flow meter will be sufficient. Otherwise, an magnetic flow meter is needed.

If district heating or cooling is present, the need for chiller electric power measurement and boiler fuel measurement can be eliminated.

### **Other Costs**

A dedicated PC to host the software needed by the technology is needed. Most products on the market are adequate. A BACnet gateway is required only if the EMCS is not BACnet compatible.

### **7.1.2 Installation Cost**

The installation cost is highly dependent on the required instrumentation. As mentioned above, the instrumentation requirements are very site-specific, and so, therefore, is the installation cost. For example, due to the roof access requirement for installing the weather station on Building 7230, the installation cost was higher than that for Building 26, even though the the equipment to be installed was similar.

## **7.2 COST DRIVERS**

Section 7.1 discussed some of the cost drivers. Several site-specific characteristics that will significantly impact cost are highlighted here:

- **Networking capability for campus applications.** If networking is available to allow sharing of the weather station, only one weather station is needed.
- **Electrical system layout.** A good electrical system design needs significantly fewer electric power meters to disaggregate the end-uses.
- **Cooling and heating distribution system.** If a long straight main pipe is not available, multiple BTU meters need to be installed on the piping branches to obtain the total.

## **7.3 COST ANALYSIS AND COMPARISON**

The MILCON ECIP template in the NIST BLCC program [20] is used to calculate the SPB (Simple Payback) and SIR (Savings to Investment Ratio) for the automated continuous commissioning system in Building 7230 and Building 26.

Section 6 provides details of savings opportunities from both buildings. We also assume there will be ~\$1,000 savings per year per building for operation and maintenance costs due to the fact that the system down-time could be reduced and the facility team could better prioritize their work orders. The following assumptions are used:

- \$0.069/kWh for electricity and \$8.7 /MMBTU for steam
- No demand charge
- Real discount rate of 3%
- Inflation rate of 1.2%

A few different capital cost scenarios (Table 24 for Building 7230, Table 25 for Building 26) were proposed after the analysis of current capital cost structure. Figure 64 illustrates the capital cost structure for both demonstration buildings. The high quality instrumentation used in the



project is required only to validate results and deployment of this technology beyond the two demonstration buildings could use less expensive instrumentation. Also, the materials (i.e., sensors and meters) and installation costs are highly dependent on specific site and buildings (e.g., roof access requirement etc). Therefore, it is reasonable to assume different capital cost scenarios.

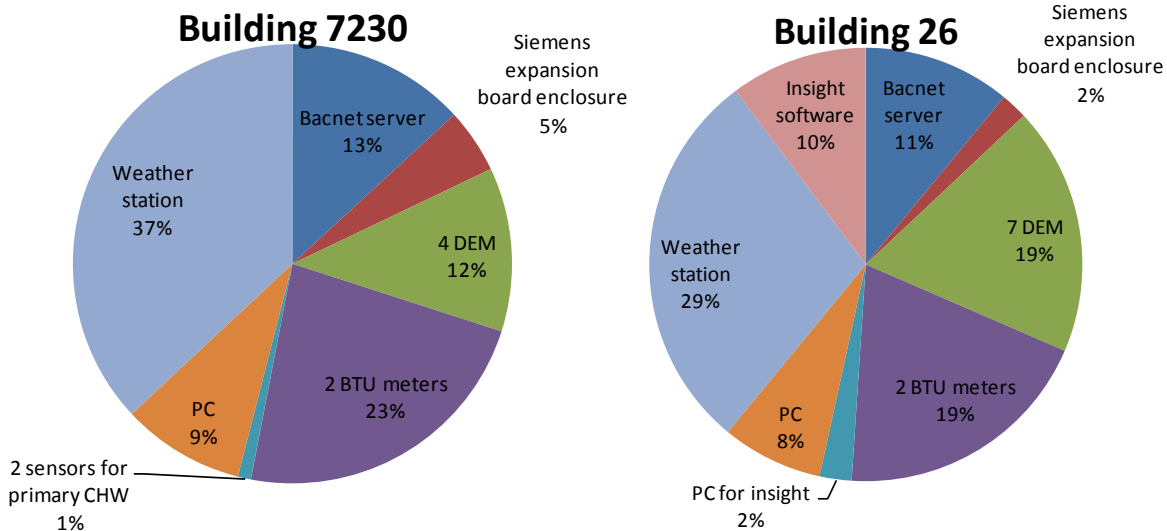

Figure 64 Pie chart plot of capital cost structure for Building 7230 and Building 26

The following assumptions are used for different capital cost scenarios:

- If the building has a native BACnet BMS, then BACnet server will not be needed.
- If there is a PC available, then a PC will not be needed.
- If the weather information can be accessed from the internet or an existing weather station on the base, then the on-site weather station will not be needed.
- If the building has BMS software, then the BMS software (e.g., the Insight software used in Building 26) will not be needed.
- The installation cost reduction is linearly related to the material cost reduction.
- To effectively use the automated continuous commissioning system, submetering is necessary. The lighting faults (Building 7230) and plug load issues (Building 26) could not have been identified without the submeters installed in this project.

The SPB and SIR in different capital cost scenarios for the automated continuous commissioning system demonstrated in the Great Lakes are summarized in the tables below.

**Table 24 Different capital cost scenarios for Building 7230**

Scenario 1 Full capital cost (\$75,923)	Scenario 2 78% of capital cost (\$59,220)	Scenario 3 63% of capital cost (\$47,831)	Scenario 4 41% of capital cost (31,128)
<ul style="list-style-type: none"> <li>• BACnet server</li> <li>• Control vendor expansion board enclosure</li> <li>• 4 DEM</li> <li>• 2 BTU meters</li> <li>• 2 sensors for primary CHW</li> <li>• PC</li> <li>• Weather station</li> </ul>	<ul style="list-style-type: none"> <li>• Control vendor expansion board enclosure</li> <li>• 4 DEM</li> <li>• 2 BTU meters</li> <li>• 2 sensors for primary CHW</li> <li>• Weather station (BACnet server and PC are removed)</li> </ul>	<ul style="list-style-type: none"> <li>• BACnet server</li> <li>• Control vendor expansion board enclosure</li> <li>• 4 DEM</li> <li>• 2 BTU meters</li> <li>• 2 sensors for primary CHW</li> <li>• PC (Weather station is removed)</li> </ul>	<ul style="list-style-type: none"> <li>• Control vendor expansion board enclosure</li> <li>• 4 DEM</li> <li>• 2 BTU meters</li> <li>• 2 sensors for primary CHW (BACnet server, PC and weather station are removed)</li> </ul>

**Table 25 Different capital cost scenarios for Building 26**

Scenario 1 Full capital cost (\$78,057)	Scenario 2 71% of capital cost (\$55,420)	Scenario 3 69% of capital cost (\$53,859)	Scenario 4 40% of capital cost (\$31,223)
<ul style="list-style-type: none"> <li>• BACnet server</li> <li>• Control vendor expansion board enclosure</li> <li>• 7 DEM</li> <li>• 2 BTU meters</li> <li>• PC for insight</li> <li>• PC</li> <li>• Weather station</li> <li>• Insight software</li> </ul>	<ul style="list-style-type: none"> <li>• BACnet server</li> <li>• Control vendor expansion board enclosure</li> <li>• 7 DEM</li> <li>• 2 BTU meters</li> <li>• PC for insight</li> <li>• PC</li> <li>• Insight software (Weather station is removed)</li> </ul>	<ul style="list-style-type: none"> <li>• Control vendor expansion board enclosure</li> <li>• 7 DEM</li> <li>• 2 BTU meters</li> <li>• Weather station (BACnet server, PC and Insight software are removed)</li> </ul>	<ul style="list-style-type: none"> <li>• Control vendor expansion board enclosure</li> <li>• 7 DEM</li> <li>• 2 BTU meters (BACnet server, PC, Insight software and weather station are removed)</li> </ul>

**Table 27 Cost analysis results for Building 7230 demonstration**

	Scenario 1 Capital cost	Scenario 2 78% of capital cost	Scenario 3 63% of capital cost	Scenario 4 41% of capital cost
First year savings:	\$11,799	\$11,799	\$11,799	\$11,799
Simple Payback Period (in years)	6.43	5.02	4.05	2.65
Savings to Investment Ratio	1.13	1.45	1.80	2.75

**Table 28 Cost analysis results for Building 26 demonstration**

	Scenario 1 Capital cost	Scenario 2 71% of capital cost	Scenario 3 69% of capital cost	Scenario 4 40% of capital cost
First year savings:	\$4,019	\$4,019	\$4,019	\$4,019
Simple Payback Period (in years)	19.42	13.79	13.40	7.77
Savings to Investment Ratio	0.37	0.53	0.54	0.93

Currently, most of the faults identified in Building 26 are related to thermal comfort rather than energy consumption. For example, due to control problems, there were times when the chiller was actually switched off when had been commanded on, so the building consumed less energy than expected but the room temperatures were not being maintained. The economic impact from occupant productivity due to lower thermal comfort is not quantified here because it is beyond the scope of this project. Based on an ASHRAE study [22] on the life cycle of a building, initial construction cost is about 2% and operational and energy cost is about 6%, while occupancy cost accounts for about 92%. The automated continuous commissioning system is able to identify issues related to thermal comfort to help address productivity problems.

## 8.0 IMPLEMENTATION ISSUES

This section includes discussions of the implementation issues in the areas of instrumentation, modeling and software, diagnostics, and visualization.

### Instrumentation

All the instrumentation is standard commercial off-the-shelf products. The recommended measurement accuracies for the power meters and thermal meters are given in *A Specifications Guide for Performance Monitoring Systems* [18]. Since the pyranometer used to measure the beam and diffuse solar radiation is not commonly used in the HVAC industry, a particular mechanical contractor may not be familiar with the installation and commissioning of the sensor. Therefore, technical assistance from the manufacturer on the installation and commissioning of the pyranometer is highly recommended.

If the EMCS is not a 'native' BACnet system, a BACnet gateway will be required to implement the technology. Care is needed when setting up the BACnet gateway. The change of value (COV) for updating the measurement for the weather station, power meters and thermal meters should be as small as possible while not overloading with the data communications.

Currently, the instrumentation cost is relatively high. The largest components are the equipment and installation costs related to submetering and the on-site weather station. It is possible and reasonable to eliminate the on-site weather station by using weather data from the internet or an existing weather station on the base. There are some ongoing research efforts for cost-effective submetering such as virtual meters.

### Modeling and software

The data obtained from the instrumentation is delivered to the software platform. The components of the software platform include the BCVTB, the database, the database API, EnergyPlus and Matlab. The software platform also includes utilities for configuring the communication connections between the software platform elements. Examples of the software platform data flow are:

- from the BACNet interface to the BCVTB
- the same data from the BCVTB to the database
- data from the database to the BCVTB
- the same data from the BCVTB to EnergyPlus
- data from EnergyPlus to the BCVTB
- the same data from the BCVTB to the database
- data from the database to Matlab
- data from Matlab to the BCVTB

For this project, the implementation of all these communication interfaces were such that they have to be maintained manually. Thus, if changes in the system, such as addition of measured points or change in input or output variables of a calculation, are frequent, the maintenance of the system could become cumbersome. The next generation system would limit any manual changes to a single location, with the changes automatically propagating to the rest of the system.

Matlab was used in this project as the platform for calculation and visualization. For a technology demonstration project, the use of Matlab is appropriate. For broader deployment,

existing Matlab code can be compiled and distributed as an executable program. In other words, the automated continuous commissioning system can be deployed on computers without Matlab.

The Matlab-based visualization is available only on the local machine (i.e. it is a “thick client”). The next generation system would utilize a web-based visualization tool.

A customized version of EnergyPlus was used in Building 7230 to override the weather data. This feature has now been incorporated in the official release of EnergyPlus.

A detailed description of steps to setup the automated continuous commissioning system is provided in section 2.0. These steps aim to help common users to setup and use the system.

## **Diagnostics and Visualization**

### *Model Development and Debugging using Remote Access*

We encountered significant challenges in the development and testing of the FDD tool because of remote access problems. Network security constraints prevented us from having broadband access to the PCs at Great Lakes. An ISDN line was set up to access the computer at Building 7230 but there were configuration issues in the initial period which prevented us from having remote access. Also, given the nature of data collection where data were being uploaded to the database in real-time from the Siemens BACnet system, we were unable to simulate a similar set-up offline. In the case of Building 26, there was no possibility of remote access.

This presented a significant challenge for coding and debugging. Team members could do efficient debugging only while visiting the site. This made it harder for the team to troubleshoot and fix complex and unforeseen issues with the code.

We recommend that remote access be granted for developers implementing similar systems at other sites.

## **Feedback from Facilities Team**

The fault detection and diagnostics module has been refined and adapted based on feedback received from the facility team at the Great Lakes site. The UTRC team visited the Great Lakes site in October 2010 and demonstrated the automated commissioning tool to the facility team.

The facility team was satisfied with the functionality of the tool but had several suggestions regarding the visualization aspects. Most of the suggestions were for visual refinements that would improve usability of the tool. The main refinements included utilizing linear scales in plots instead of log-scales, having legends outside of the plots so the plots were more readable, displaying the units of different variables in the tool and modifying some of the plot titles to make them more readable.

There was some additional functionality that we had implemented but was removed from the final tool, based on facility team feedback. The team felt that the complexity of this additional functionality limited the facility team-members’ ability to extract any actionable information and outweighed any additional information they provided.

- The tool initially had the ability to display a carpet-plot of building energy consumption in the main energy dashboard. In a carpet-plot, the time of day is plotted on one axis and the day is plotted on the other axis. The energy consumption at a particular date and time is encoded by the color of the pixel corresponding to that point in the plot.

- The tool had the ability to display scatter-plots of any pair of variables that were being monitored. This is illustrated in Figure 65.

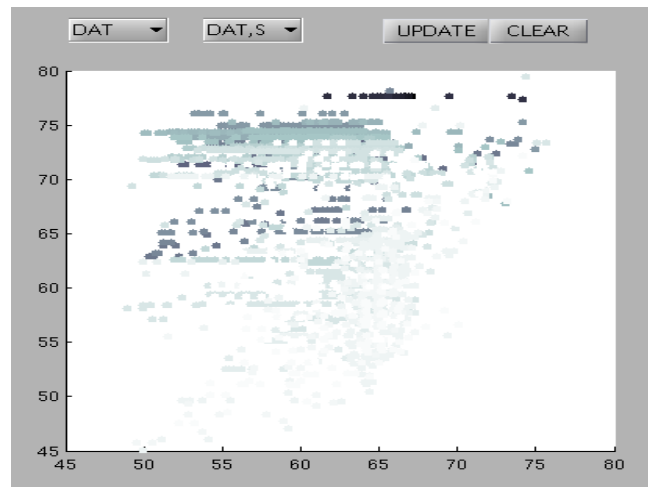

Figure 65 Illustration of the scatter-plot utility that was eventually removed from the automated commissioning visualization tool.

Using this Automated Continuous Commissioning Tool currently requires the installer to have the following skills:

- **Create an EnergyPlus model.** EnergyPlus, developed by Department of Energy (DOE), is a whole building energy simulation program that engineers, architects, and researchers use to model energy and water use in buildings. Modeling the performance of a building with EnergyPlus enables building professionals to optimize the building design to use less energy and water. DOE regularly provides training on how to use EnergyPlus. Also, the Appendices B and C provide detailed descriptions of EnergyPlus model for demonstration buildings used in the project. The current development of a comprehensive graphical user interface (GUI) for EnergyPlus by a team led by LBNL [19] will make a number of different aspects of modeling buildings, including existing buildings, simpler, faster and less prone to error.
- **Use the BCVTB.** The BCVTB is an open source software platform for building data acquisition, and the integration of real time data and EnergyPlus model. The BCVTB makes use of Ptolemy II [8], an open source software environment for combining heterogeneous modeling and simulation tools. A detailed description of the steps required to use the BCVTB is provided in section 2.0.

The response to the ESTCP IPR action items can be found from Appendix H.

## 9.0 REFERENCES

1. <http://www.whitehouse.gov/news/releases/2007/01/20070124-2.html>
2. *Potential of On-line Simulation for Fault Detection and Diagnosis in Large Commercial Buildings with Built-up HVAC Systems*, Energy Systems Laboratory, University of Nebraska and Energy Systems Laboratory, Texas A&M University, June 2002.
3. E. Mills et al, *The Cost-Effectiveness of Commercial Buildings Commissioning*, LBNL-56637, Nov. 2004.
4. D. Chu, C.L. Burton, L.V. Speirs, A.J. Pacheco, and S.Campbell, “Acceptance Testing Procedures for Heating, Ventilating, and Air-Conditioning Systems” by USACERL Technical Report 99/20, May 1999.
5. O'Neill, Z., Shashanka, M., Pang, X., Bhattacharya, P., Bailey, T. and Haves, P. “Real Time Model-based Energy Diagnostics in Buildings.” *Proc. Building Simulation '11*, Sydney, Australia, November 2011.
6. <http://www.eere.energy.gov/buildings/energyplus/>.
7. <http://bimology.blogspot.com/2007/11/green-building-studio-30-released.html>
8. Wetter, M. 2011. Building Control Virtual Test bed Manual. <http://simulationresearch.lbl.gov/bcvtb/releases/1.0.0/doc/manual/bcvtb-manual.pdf>
9. <http://ptolemy.berkeley.edu/ptolemyII/>
10. DesignBuilder 2.0, 2010. <http://www.designbuilder.co.uk/>
11. DoE. 2010. EnergyPlus documentation: engineering reference.
12. <http://www.mathworks.com/products/matlab/>
13. Pang, X., Bhattacharya, P., O'Neill, Z., Haves, P., Wetter, M., Bailey, T. “Real-time Building Energy Simulation using EnergyPlus and the Building Controls Virtual Test Bed.” *Proc. Building Simulation '11*, Sydney, Australia, November 2011.
14. Nouidui, T.S., Wetter, M., Li, Z., Pang, X., Bhattacharya, P. and, Haves, P. “BACnet and Analog/Digital Interfaces for the Building Controls Virtual Test Bed.” *Proc. Building Simulation '11*, Sydney, Australia, November 2011.
15. Friedman, H. and M.A. Piette, *A Comparative Guide to Emerging Diagnostic Tools for Large Commercial HVAC Systems*, LBNL Report 48629, LBNL, Berkeley CA, May 2001.
16. Gillespie, K.L, Haves, P., Hitchcock, R.J., Derringer, J.J. and Kinney, K.L. A Guide for Specifying Performance Monitoring Systems in Commercial and Institutional Buildings. *Proceedings of 14th National Conference on Building Commissioning*. San Francisco, CA. 2006.
17. *A Specifications Guide for Performance Monitoring Systems*, Lawrence Berkeley National Laboratory, Berkeley CA, 2007.
18. <http://cbs.lbl.gov/performance-monitoring/specifications/>

19. See, R., Haves, P., Sreekanthan, P., Basarkar, M. and Settlemyre, K. "Development of a Comprehensive User Interface for the EnergyPlus Whole Building Energy Simulation Program." *Proc. Building Simulation '11*, Sydney, Australia, November 2011.
20. [http://www1.eere.energy.gov/femp/information/download\\_blcc.html](http://www1.eere.energy.gov/femp/information/download_blcc.html)
21. O'Neill, Z., Narayanan, S. and Brahme, R. 2010. Model-based Thermal Load Estimation in Buildings, Proceedings of SimBuild 2010. New York City, NY. IBPSA-USA.
22. Aimdyn GoSUM Software, 2010. Global Optimization, Sensitivity and Uncertainty in Models (GoSUM). Santa Barbara, CA: Aimdyn Inc. Available from: <http://aimdyn.com> [Accessed August 11, 2010].
23. Sobol, I. and S. Kucherenko. 2009. Derivative based global sensitivity measures and their link with global sensitivity indices. *Mathematics and Computers in Simulation*, 79, 3009-3017.
24. Eisenhower, B., Z. O'Neill, V. Fonoberov, and I. Mezic'. 2011. Uncertainty and sensitivity decomposition of building energy models. *Journal of Building Performance Simulation*. Available on line, In press.
25. ASHRAE Standard 90.1-2004. Energy Standard for Buildings Except Low-Rise Residential Buildings
26. ASHRAE existing building conference, presidential keynote presentation, New York City, NY, April 2010.



## APPENDICES

### Appendix A: Points of Contact

POINT OF CONTACT Name	ORGANIZATION Name Address	Phone Fax E-mail	Role in Project
Trevor Bailey	United Technologies Research Center 411 Silver Lane, MS 129-78 East Hartford, CT, 06108	Ph. (860) 610-1554 Fax (860) 660-1014 Email: BaileyTE@utrc.utc.com	Project Leader
Philip Haves	Lawrence Berkeley National Laboratory One Cyclotron Road, MS 90R3111 Berkeley, CA 94720-8134	Ph. (510) 486 6512 Fax (510) 486 4089 Email: phaves@lbl.gov	Co-PI
Peter Behrens	Public Works Department, Great Lakes 2625 Ray Street Great Lakes, IL 60088-3147	Ph. (847) 688-2121 x28 Fax: 847-688-2124 Email: peter.behrens@navy.mil	Navy Great Lakes Energy Manager

## Appendix B: Equipment Calibration and Data Quality Issues

### Calibration of Equipment

All the equipment specified in Section 5.3 was calibrated when installation was complete. The calibration procedures strictly followed manufacturer guidelines.

During the building performance monitoring period, we have paid close attention to collected data points from the BMS in terms of sensor drifting. We applied a data statistical analysis protocol that computes various statistics to ensure computed values are within acceptable ranges. Specifically, data for each measured point were used to compute the minimum value, maximum value, mean (average) and standard deviation. If the computed values were outside of the reference range, then the data were flagged and further analyzed to identify the root cause. The majority of our measurement points were directly from existing BMS, the controller vendors (e.g., Siemens at Great Lakes) closely monitor these points based on control industry standards and protocols to make sure that all the measurements are in the acceptable accuracy band.

### Calibration of Reference Model

The EnergyPlus model represents the desired performance of the building envelope, HVAC, lighting and control systems. Metering data for building electricity and hot water usage, and sub-metering data for HVAC equipment (e.g., AHUs, chillers, pumps) were used to calibrate and validate the EnergyPlus model. Some monitored data such as real-time weather data were processed to provide inputs for the model. During the calibration process, some inputs such as weather and internal gains (loads) were calibrated as accurately as possible. The details about the calibration approach can be found from Appendix E.

### Quality Assurance Sampling

Data quality is very important for the performance of the proposed automated continuous commissioning system. The sampling frequency has effects on the types of faults that the system can detect. In general, a faster sampling frequency is better. Since the goal was to detect the energy consumption related faults, a five-minute sample frequency was used. Scripts were used to automatically remove the duplicated data and spiked samples from raw data, synchronize data, and output clean, conditioned data for an analysis within the automated continuous commissioning system.

The reality of instrumentation related research is that missing data is possible even though the instrumentation and monitor systems are designed and commissioned to be reliable. Statistic methods such as extrapolation, interpolation and trend analysis, augmented by domain expertise, were applied to fill the missing data.

In terms of quality assurance sampling, we took the following efforts:

- Duplicates – We had two measurements for some important points in the building system. For example, there are duplicated temperature measurements for both hot water and chilled water. The current EMCS already has water temperature sensors, and additional paired water temperature sensors (supply and return) were installed at the appropriate location. This improved reliability and quality of the data collected.
- Spiked samples – Spiked samples are defined as measurements that are taken for certain points and then compared against expected values obtained in “laboratory setting”. Spiked samples are used to measure accuracy. For the sensors used in building systems such as temperatures

sensor and flow sensors, it is difficult to have this spiked sample testing after these sensors are in place. However, these sensors have been tested and calibrated before the installation. For example, temperatures sensors are usually calibrated in the lab for certain points such as 0°C (ice-water mixture) and 100°C (water boiling point).

- Blanks samples - Blank samples are clean samples, produced in the field, used to detect analytical problems during the whole process. In the automated continuous commissioning system, blanks samples were created when the building was in normal operation in order to establish and calibrate a baseline model.

### Data Analysis

Quality of the data acquired from the BMS is crucial for the success of this project and data quality review is an integral aspect of the implemented approach. Robust data quality evaluation includes testing for precision, accuracy, representativeness (including sampling rate and latency issues) and completeness of the data.

Data precision [1] is the closeness of agreement between indications obtained by replicate measurements on the same or similar objects under specified conditions. Precision is used to define measurement repeatability and measurement reproducibility. Repeatability is the variability of a measurement due to keeping all controllable and uncontrollable factors constant. It is typically measured by taking data very close together in time, under as close to the same conditions as possible in a laboratory setting. Reproducibility is the variability due to specific controllable or uncontrollable factors by observing measurements at various system configurations. Typical statistical techniques used to accomplish this are analysis of variance and analysis of covariance methods. We used the specification sheets provided by sensor manufacturers as a guideline but in cases where sensors didn't perform as expected, then further analysis and in-house testing were performed.

In addition to the above steps, the data collected from the BMS is subjected to a protocol that computes various statistics on the data to ensure computed values are within acceptable ranges. Specifically, data for each measured point were used to compute the minimum value, maximum value, mean (average) and standard deviation. These were computed periodically for various lengths of time and the values were compared with reference values obtained from accuracy analysis (using spiked values or duplicates when appropriate). If the computed values were outside of the reference range, then the data were flagged and further analyzed to identify and (and possibly discard) any spurious data points. This process served as a final sanity-check before the data were used for diagnostics.

### **Reference**

1. Crispieri, G. 2008. Data Quality Evaluation Methods. *International SEMATECH Manufacturing Initiative*, Technology Transfer #08074943A-ENG. July 2008.

[Available at <http://www.sematech.org/docubase/document/4943aeng.pdf>]

## Appendix C: Detailed Energy Modeling –Drill Hall

### EnergyPlus Building Energy Model

The EnergyPlus interface used for this analysis is DesignBuilder, which allows for a graphical display of all the three-dimensional geometry. After the geometry is entered into DesignBuilder, an IDF file with all geometry information is exported, and then IDF Editor is used to create the HVAC system model. The image in Figure 1 contains rendered geometry outline generated by DesignBuilder.



Figure 1 Rendered Geometry generated by DesignBuilder

The EnergyPlus used in this project is version 4.0. EnergyPlus models an HVAC system as a series of modules connected by fluid loops as shown in Figure 2. The fluid loops (air and water) are divided into a supply and a demand side.

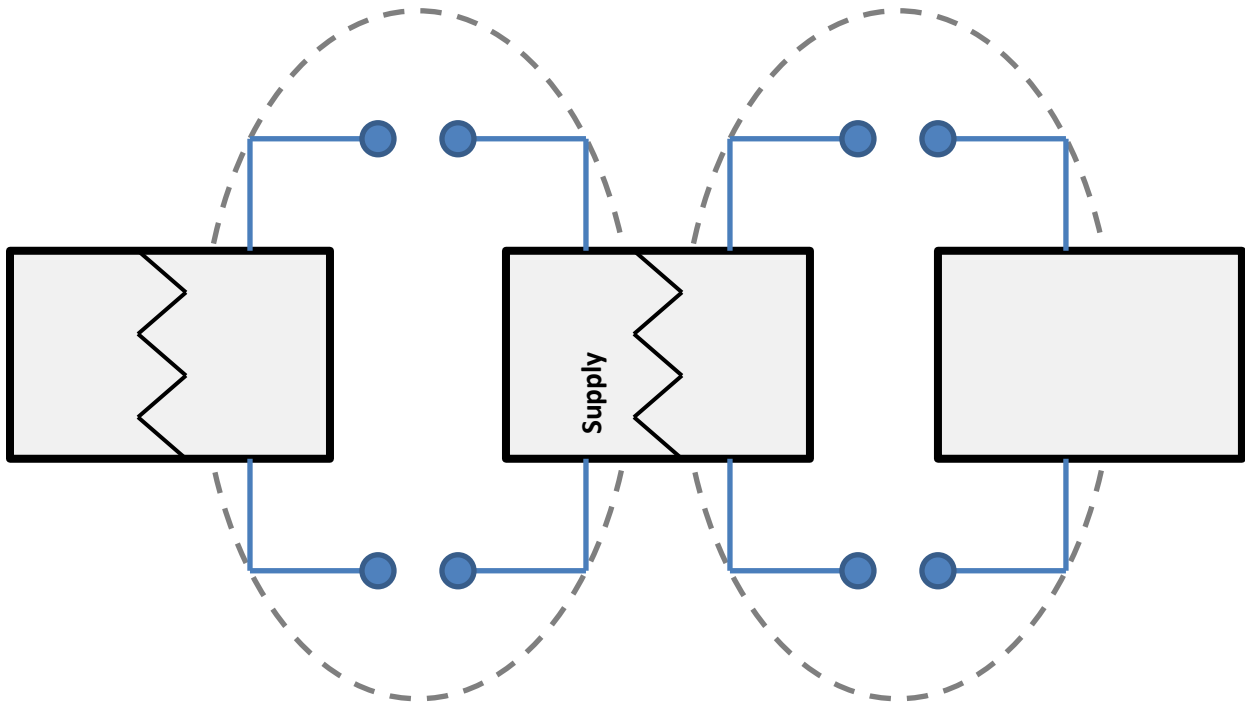

Figure 2 HVAC System conceptual connections in EnergyPlus

The details of the building energy model are described in the following sections.

*Energy Modeling Package Description*

The energy model for the Drill Hall Building was built using the EnergyPlus version 4.0, build 4.0.0.024. The weather file used in this simulation is the TMY3 data for Chicago, O’Hare airport. When the real time weather data, including outside dry bulb temperature, wet bulb temperature, wind information and solar radiation etc., is available, the real time data will be used to drive the simulation.

*Building Zoning*

In order to keep the amount of detail required to run a reasonable and manageable energy analysis, zoning simplifications are made when entering the building geometry. The images below indicate the zoning used for the Drill Hall Building.

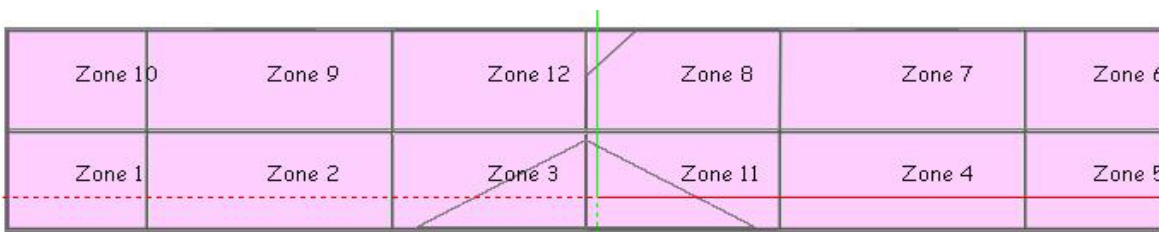

Floor 1 Drill Deck zoning

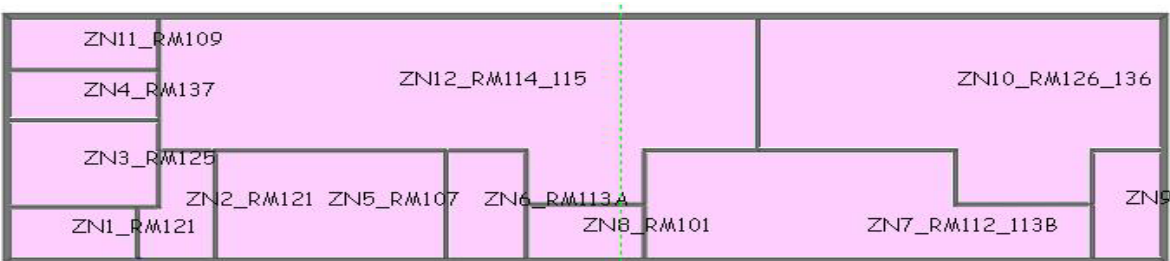

Floor 1 Office area zoning

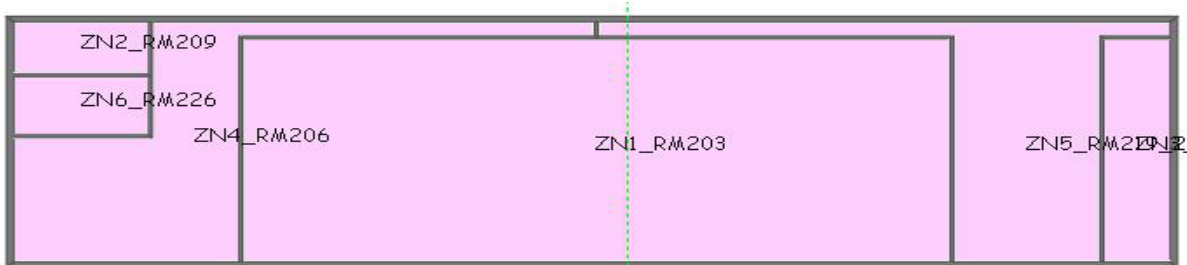

Floor 2 Office area zoning

*Building Opaque Envelope*

The opaque wall surface constructions are described in the table below:

Wall Type	Materials	Equivalent R value
Interior Wall	5/8'' GYP, 3-5/8'' metal stud 5/8'' GYP	7.194 ft <sup>2</sup> -F-hr/BTU
Exterior wall	4'' face brick, 1'' airgap ,2- 3/4'' rigid insulation, 8'' CMU, 5/5'' GYP	14.71 ft <sup>2</sup> -F-hr/BTU
Roof		28.359 ft <sup>2</sup> -F-hr/BTU

Roof is modeled with a 0.31 solar absorbance and 0.87 thermal absorbance.

### Glazing

The Glazing properties are summarized below.

Category	U-factor	SHGC	Visible Transmittance
Double pane windows (Clear 3mm + airgap + clear 3mm)	2.782 W/m <sup>2</sup> -K	0.765	0.812
Coated poly-33	5.396	0.203	0.331

The properties for glass types of “coated poly-33” and “clear 3mm” used in the simulation mode are listed below:

COATED POLY-33,      !- Name  
SpectralAverage,      !- Optical Data Type  
0.00051,              !- Thickness {m}  
0.178,                  !- Solar Transmittance at Normal Incidence  
0.739,                  !- Front Side Solar Reflectance at Normal Incidence  
0.738,                  !- Back Side Solar Reflectance at Normal Incidence  
0.330,                  !- Visible Transmittance at Normal Incidence  
0.566,                  !- Front Side Visible Reflectance at Normal Incidence  
0.591,                  !- Back Side Visible Reflectance at Normal Incidence  
0.0,                      !- Infrared Transmittance at Normal Incidence  
0.035,                  !- Front Side Infrared Hemispherical Emissivity  
0.720,                  !- Back Side Infrared Hemispherical Emissivity  
0.14,                    !- Conductivity {W/m-K}  
1;                        !- Dirt Correction Factor for Solar and Visible Transmittance

CLEAR 3MM,            !- Name  
SpectralAverage,      !- Optical Data Type  
0.003,                  !- Thickness {m}  
0.837,                  !- Solar Transmittance at Normal Incidence  
0.075,                  !- Front Side Solar Reflectance at Normal Incidence

- 0.075, !- Back Side Solar Reflectance at Normal Incidence
- 0.898, !- Visible Transmittance at Normal Incidence
- 0.081, !- Front Side Visible Reflectance at Normal Incidence
- 0.081, !- Back Side Visible Reflectance at Normal Incidence
- 0.0, !- Infrared Transmittance at Normal Incidence
- 0.84, !- Front Side Infrared Hemispherical Emissivity
- 0.84, !- Back Side Infrared Hemispherical Emissivity
- 0.9; !- Conductivity {W/m-K}
- 1; !- Dirt Correction Factor for Solar and Visible Transmittance

*Occupancy*

The table below lists the occupancy schedule for different areas in the Drill Hall. The maximum people for each zone can be found from the appendix c1.

Drill Hall		Office		Conference		Classroom	
hours	fraction	hours	fraction	hours	fraction	hours	fraction
7--9	0.9	6--7	0.1			7--9	0.05
9--10	0	7--8	0.2	10--11	0.5	9--10	0
10--12	0.9	8--12	0.95	11--2	0	10--12	0.05
12--1	0	12--1	0.5	2--3	0.5	12--1	0
1--3	0.9	1--5	0.95	3--10	0	1--3	0.05
3--4	0	5--6	0.3			3--4	0
4--6	0.9	6--10	0.1			4--6	0.05
6--7	0	10---12	0.05			6--7	0
		12--6	0				

*Lighting*

The table below lists the lighting schedule for different areas in the Drill hall. The lighting power density (W/m2) used for individual zones can be found from the appendix C1.

Drill Hall		Office		Conference		Classroom		Server room	
hours	fraction	hours	fraction	hours	fraction	hours	fraction	hours	fraction
6--19	0.95	5--7	0.1			7--9	0.05		
		7--8	0.3	10--11	0.5	9--10	0	10--11	0.8
		8--12	0.9	11--2	0	10--12	0.05	11--2	0
		12--1	0.8	2--3	0.5	12--1	0	2--3	0.8
		1--5	0.9	3--10	0	1--3	0.05	3--10	0
		5--6	0.5			3--4	0		
		6--10	0.2			4--6	0.05		
		10---12	0.05			6--7	0		
		12--5	0.05						
weekend	0	weekend	0.05	weekend	0	weekend	0	weekend	0

*Equipment*

The table below lists the equipment schedule for different areas in the Drill hall. The equipment power density ( $W/m^2$ ) used for individual zones can be found from the appendix A.

Lounge		Office		Conference		Classroom		Server room	
hours	fraction	hours	fraction	hours	fraction	hours	fraction	hours	fraction
5--7	0.3	5--7	0.1	10--11	0.5				
7--9	0.9	7--8	0.3	11--2	0	7--9	0.05		
9--12	0.3	8--12	0.9	2--3	0.5	9--10	0	24 hrs	1
12--1	0.9	12--1	0.8	3--10	0	10--12	0.05		
1--3	0.3	1--5	0.9			12--1	0		
3--4	0.9	5--6	0.5			1--3	0.05		
4--6	0.4	6--10	0.2			3--4	0		
6--5	0.3	10--12	0.05			4--6	0.05		
		12--5	0.05			6--7	0		
weekend	0.3	weekend	0.05	weekend	0	weekend	0		

#### DHW demand

Domestic hot water is served to the building at maximum rate 2.25kg/s with an appropriate schedule. The domestic hot water supply temperature setpoint is 60°C.

#### HVAC System Setup

There are four variable volume air handler units in the Drill Hall. The static data for these four AHUs are listed in the table below.

	CFM	Cooling Coil							OA CFM	SF TSP (IN)	RF TSP (IN)
		EAT(DB)	EAT(WB)	LAT(DB)	LAT(WB)	EWT	LWT	GPM			
AHU1	19000	84.7	69.3	53.8	53.6	44	55.2	175	6000	4	1.4
AHU2	19000	84.7	69.3	53.8	53.6	44	55.2	175	6000	4	1.4
AHU3	7400	87.3	70.5	55.3	55.2	44	54.2	75	3600	4.7	1.1
AHU4	8730	82.9	68.5	57.2	57.2	44	56.1	55	1700	3.8	1.3

	Heating Coil						
	CFM	EAT(DB)	LAT(DB)	EWT	LWT	GPM	MBH
AHU1	19000	44.7	91.8	180	150	69	979
AHU2	19000	44.7	91.8	180	150	69	979
AHU3	7400	31.1	92.1	180	150	35	494
AHU4	8730	54.4	80.2	180	140	13	246

AHU operation schedule is listed as follows:

	Operation Schedule
AHU1	06:00 to 22:00 7 days a week
AHU2	06:00 to 22:00 7 days a week
AHU3	06:00 to 19:00 7 days a week
AHU4	05:00 to 19:00 7 days a week



### *HVAC Zone Setup*

For the office area, each zone is model as a VAV with reheat coiling zone. Minimums and maximums are simulated as follows:

	Min CFM	Max CFM
VAV1	325	1100
VAV2	325	1220
VAV3	230	935
VAV4	450	1815
VAV5	80	370
VAV6	450	1900
VAV7	325	1390
VAV8	45	100

In the drill deck and the classroom on the second floor, central system air is directly supplied to a zone without any zone level control or tempering. The supply air temperature has been adjusted to control the temperature in the control zone. EnergyPlus objective-AirTerminal:SingleDuct:Uncontrolled- is used to simulate this configuration.

Thermostat schedules for all zones are as follows:

Cooling set point: 24.4°C occupied, 30°C unoccupied

Heating set point: 21.1°C occupied, 15°C unoccupied

### *Building Water Distribution Loops*

Both the heating water and chilled water distribution loops in the building are modeled as variable flow systems including variable speed drives on the pumps (primary chilled water pump is constant speed pump) and 2-way valves on all heating and cooling coils in AHUs.

The primary and secondary chilled-water loop is modeled with a set-point temperature of 6.7°C. Pumps are modeled with premium efficiency motors. The variable frequency drive modulates secondary chiller water pump speed to maintain a differential pressure of 10PSI of secondary water loop.

The heating-water loop is modeled with a set-point temperature of 82.2°C. Pumps are modeled with premium efficiency motors.

Pump power consumption is described by the following part load performance curve

$$\text{FractionFullLoadPower} = C_1 + C_2\text{PLR} + C_3\text{PLR}^2 + C_4\text{PLR}^3$$

### *Plant Energy Model*

Two 100-ton air cooled chillers (Carrier 30XAA6N-0-SM3) are used in the chiller plant. This chiller model is the empirical model used in the DOE-2.1 building energy simulation program. The model uses performance information at reference conditions along with three curve fits for cooling capacity and efficiency to determine chiller operation at off-reference conditions. Chiller performance curves are generated by fitting manufacturer's catalog.

Cooling is available from April 15th to October 15th. Whenever outside air temperature is greater than 58°C, chiller will be turned on. Whenever outside air temperature is less than 56 °C, chiller will be turned off.

Cooling Capacity Function of Temperature Curve

A biquadratic performance curve parameterizes the variation of the cooling capacity as a function of the leaving chilled water temperature (x) and the entering condenser fluid temperature (y). The output of this curve is multiplied by the reference capacity to give the cooling capacity at specific temperature operating conditions (i.e., at temperatures different from the reference temperatures).

```

ChillerCapFT,      !- Name
0.385122,          !- Coefficient1 Constant
0.065074,          !- Coefficient2 x
-0.00072,          !- Coefficient3 x**2
0.02385,           !- Coefficient4 y
-0.00036,          !- Coefficient5 y**2
-0.00072,          !- Coefficient6 x*y
5.0,               !- Minimum Value of x
10.0,              !- Maximum Value of x
24.0,              !- Minimum Value of y
45;                !- Maximum Value of y

```

Electric Input to Cooling Output Ratio Function of Temperature Curve

A biquadratic performance curve parameterizes the variation of the energy input to cooling output ratio (EIR) as a function of the leaving chilled water temperature (x) and the entering condenser fluid temperature (y). The EIR is the inverse of the COP. The output of this curve is multiplied by the reference EIR (inverse of the reference COP) to give the EIR at specific temperature operating conditions (i.e., at temperatures different from the reference temperatures).

```

ChillerEIRFT,      !- Name
0.262065,          !- Coefficient1 Constant
0.019233,          !- Coefficient2 x
-0.000519,         !- Coefficient3 x**2
0.012245,          !- Coefficient4 y
0.000258,          !- Coefficient5 y**2
-0.000458,         !- Coefficient6 x*y
5.0,               !- Minimum Value of x
10.0,              !- Maximum Value of x
24.0,              !- Minimum Value of y
45;                !- Maximum Value of y

```

Electric Input to Cooling Output Ratio Function of Part Load Ratio Curve

A quadratic performance curve parameterizes the variation of the energy input ratio (EIR) as a function of the part-load ratio. The EIR is the inverse of the COP, and the part-load ratio is the actual cooling load divided by the chiller's available cooling capacity. The output of this curve is multiplied by the reference EIR (inverse of the reference COP) and the Energy Input to Cooling Output Ratio Function of temperature Curve to give the EIR at the specific temperatures and part-load ratio at which the chiller is operating.

ChillerEIRFPLR,	!- Name
0.2321,	!- Coefficient1 Constant
-0.8352,	!- Coefficient2 x
1.5157,	!- Coefficient3 x**2
0.0,	!- Minimum Value of x
1.5;	!- Maximum Value of x

Appendix C1:

Zone Name	Rooms	Units	Floor Area (m2) E+ Zones*	Used in E+ Internal Wall Area (m2)	Used in E+ model Furnishing Area (m2)	Used in E+ model Estimated Max People	Used in E+ model Lighting (W)	Lighting (W m-2)	Equipment (W)	Used in E+ model Equipment (W m-2)	Light Types and Quantities
<b>Drill Hall (DH_ZN#)</b>		AHU1/2	3580.31			500					
DHZone1			211.16			29	1600	7.58			
DHZone2			371.85			52	2400	6.45			
DHZone3			293.97			41	2400	8.16			
DHZone4			371.95			52	2400	6.45			
DHZone5			211.16			29	1600	7.58			
DHZone6			221.28			31	1600	7.23			
DHZone7			389.33			54	2400	6.16			
DHZone8			302.30			42	2400	7.94			
DHZone9			389.78			54	2400	6.16			
DHZone10			221.28			31	1600	7.23			
DHZone11			293.97			41	2400	8.16			
DHZone12			302.30			42	2400	7.94			
<b>FL1 Office (FL1_ZB#)</b>											
ZN1_RM121 Electric R	RM121	SUH-7	13.32		9.33		128	9.61	0.00	0.00	2J
ZN2_RM111 Comm	RM111	DFSS-2	14.78		10.34		128	8.66	794.90	53.80	2J
ZN3_RM125 Mech	RM125	SUH-1	26.51		18.56		256	9.66	450.00	16.97	4J
ZN4_RM137 Maint (PC	RM137	SUH-2	15.30		10.71		128	8.37	100.00	6.54	2J
ZN5_RM107 Conf	RM107	VAV-6	51.30		35.91	27	576	11.23	504.00	9.83	6A
ZN6_RM113A Off	RM113A	VAV-5	17.76		12.43		192	10.81	172.00	9.68	2A
ZN7_RM112_113B Lou	RM112, 11	VAV-4	84.32	85.68	59.03		648	7.68	745.00	8.84	2A, 4B, 4D, 1KB, 1M
ZN8_RM101	RM101	CUH-3	13.09		9.16		104	7.95	0.00	0.00	4D
ZN9_RM123 stair	RM123	CUH_2	15.12		10.58		64	4.23	0.00	0.00	1B
ZN10_RM126_136	RM126,13	VAV-3	124.03	150.75	86.82		1300	10.48	265.00	2.14	11B,6J, 2AA,1D,1KB,,1M
ZN11_RM109 stair	RM109	CUH-1	15.52		10.86		116	7.47	0.00	0.00	2B, 2D
ZN12_RM114_115	RM114A,1	VAV-7	175.34	210.48	122.74		2342	13.36	903.00	5.15	14BB,,6B,6T,4D,8G
<b>FL2 Office (FL2_ZN#)</b>											
ZN1_RM203	RM203	AHU3	325.60		227.92	176	4416	13.56	1500.00	4.61	46A
ZN2_RM209 stair	RM209		14.86		10.40		128	8.61	0.00	0.00	2B
ZN3_RM223 stair	Rm223		31.34		21.94		256	8.17	0.00	0.00	4B
ZN4_RM206	RM206,20	VAV2	90.57		63.40		960	10.60	550.00	6.07	6A,6K1
ZN5_RM219_227	RM219,22	VAV1	86.85		60.80		1152	13.26	637.00	7.33	8A,6K1
ZN6_RM226	RM226	DFSS-1	17.20		12.04		192	11.16	925.52	53.8	2C
Floor1 Plenum Zone1									0.00		
<b>Attic_East1</b>											
MechRM101			119.15				384	3.22			6J
ZN1_Attic_East1											
ZN2_Attic_East1											
<b>Attic_East2</b>											
ZN1_Attic_East2											
<b>Attic_West1</b>											
MechRM229		SUH-3/4	208.73				640	3.07			10J
ZN1_Attic_West1											
ZN2_Attic_West1											
<b>Attic_West2</b>											
ZN1_Attic_West2											
Entrance Zone 1							280				4S
<b>Floor1_West</b>											
MechRM138		SCH-5/6	24.53				192	7.83			3J
ReruitHead131_132			127.78	239.53			1440	11.27			15N
ReruitHead134_135			127.78	239.53			1440	11.27			15N
RecruitSupport136			43.58				320	7.34			2N,2J
RecruitEntrance Zone1							560				8S
RecruitEntrance Zone2							560				8S

## Appendix D: Detailed Energy Modeling –BLDG26

### EnergyPlus Building Energy Model

The EnergyPlus interface used for this analysis is DesignBuilder, which allows for a graphical display of all the three-dimensional geometry. After the geometry is entered into DesignBuilder, an IDF file with all geometry information is exported, and then IDF Editor is used to create the HVAC system model. The image in Figure 1 contains rendered geometry outline generated by DesignBuilder.

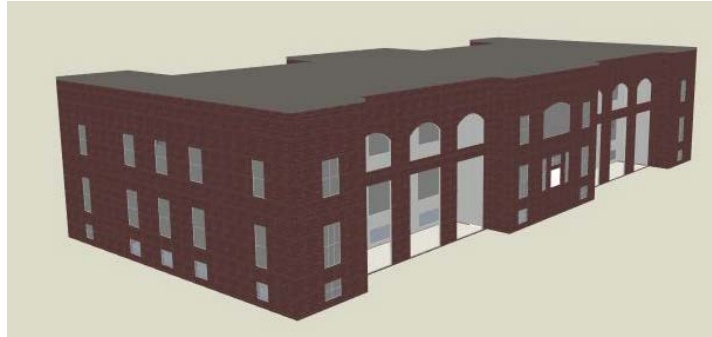

Figure 1 Rendered Geometry generated by DesignBuilder

The EnergyPlus used in this project is version 6.0. The details of the building energy model are described in the following sections.

#### *Energy Modeling Package Description*

The energy model for BLDG26 was built using the EnergyPlus version 6.0, build 6.0.0.023. The weather file used in this simulation is the TMY3 data for Chicago, O'Hare airport. When the real time weather data, including outside dry bulb temperature, wet bulb temperature, wind information and solar radiation etc., is available, the real time data will be used to drive the simulation.

#### *Building Zoning*

In order to keep the amount of detail required to run a reasonable and manageable energy analysis, zoning simplifications are made when entering the building geometry. The images below indicate the zoning used for Building 26.

Office\_OpenOff

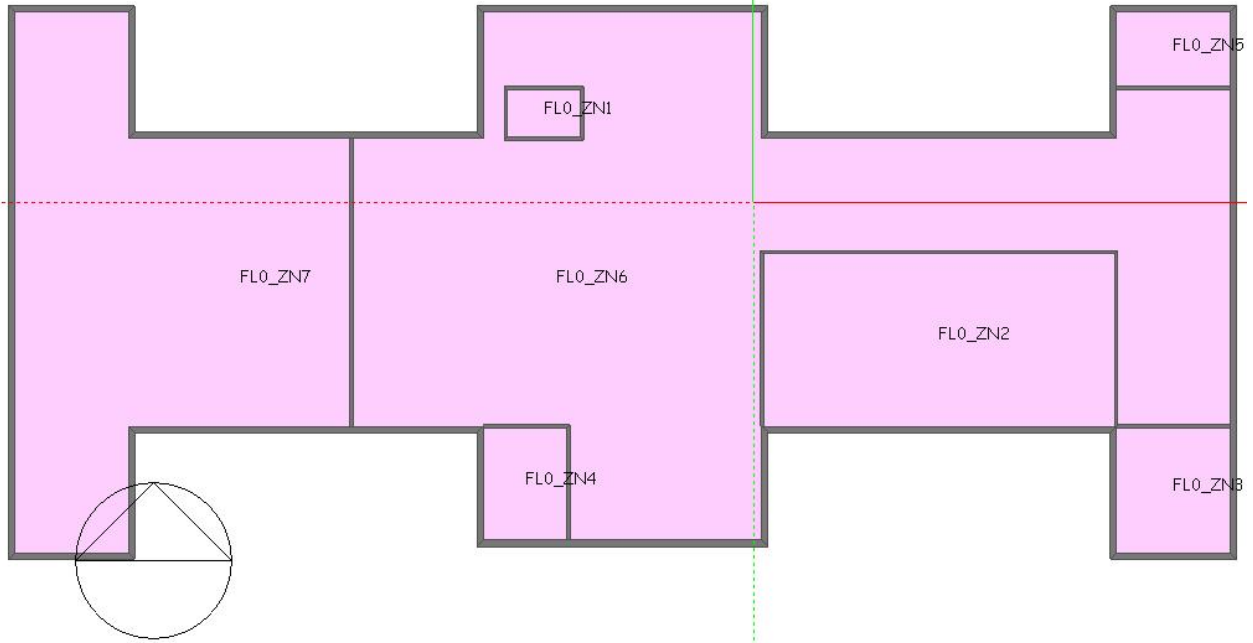

Basement zoning

Office\_OpenOff

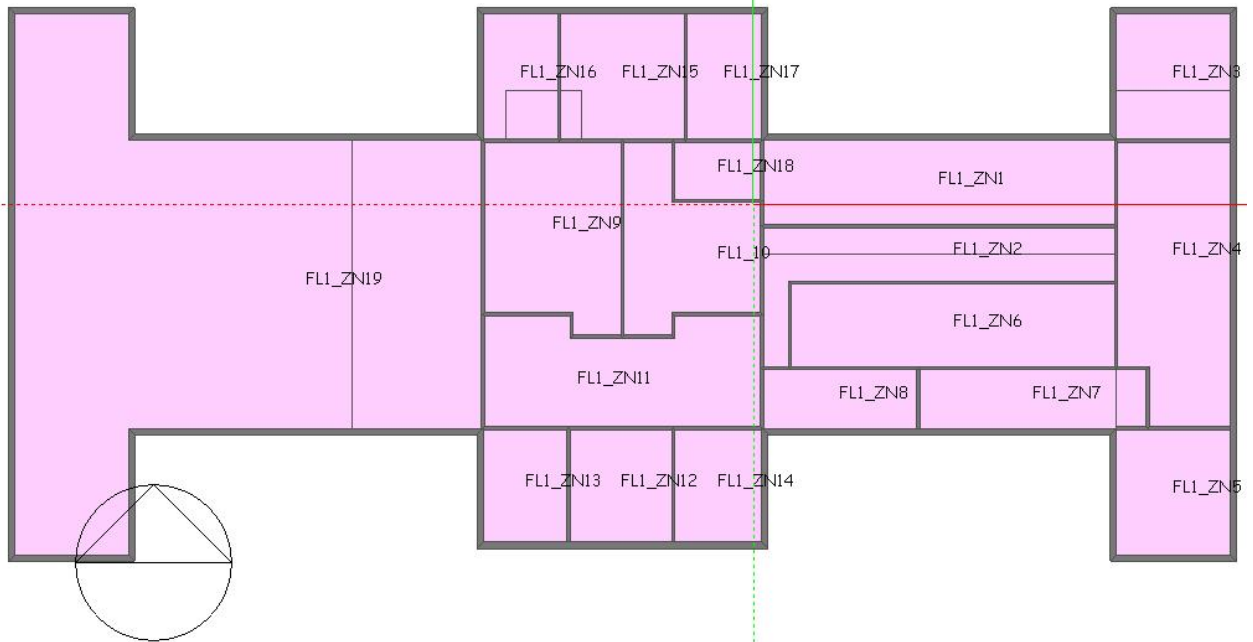

Floor 1 zoning

Office\_OpenOff

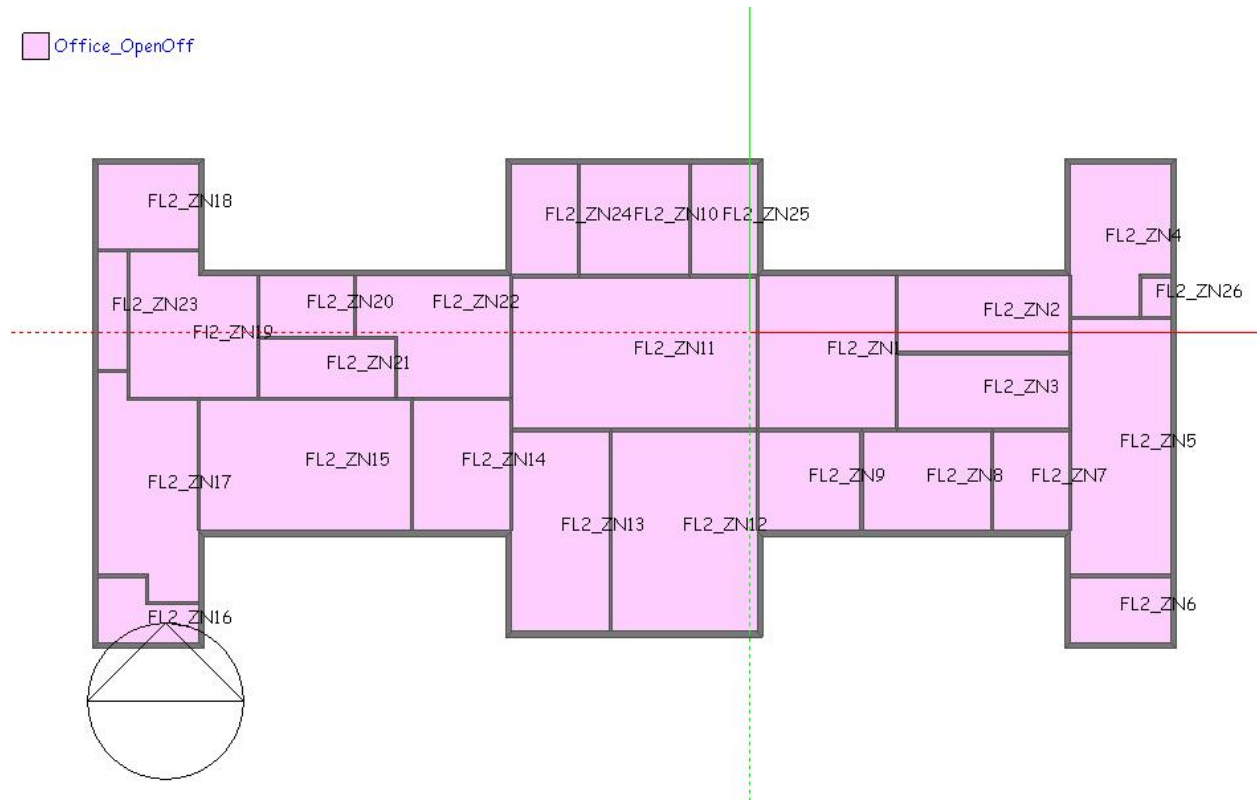

Floor 2 zoning

*Building Opaque Envelope*

The opaque wall surface constructions are described in the table below.

Wall Type	Materials	Equivalent R value
Exterior wall	4" face brick, XPS extruded polystyrene, 4" concrete block 0.512 GYP	16.31 ft <sup>2</sup> -F-hr/BTU
Roof		22.791 ft <sup>2</sup> -F-hr/BTU

Roof is modeled with a 0.85 solar absorptance and 0.9 thermal absorptance

*Glazing*

The Glazing properties are summarized below.

Category	U-factor	SHGC	Visible Transmittance
Generic Clear 6mm	1.018 W/m <sup>2</sup> -K	0.819	0.881
Coated poly-33	5.396	0.203	0.331

The properties for glass types of “coated poly-33” and “clear 6mm” used in the simulation mode are listed below:

- COATED POLY-33,      !- Name
- SpectralAverage,      !- Optical Data Type

0.00051,            !- Thickness {m}  
0.178,              !- Solar Transmittance at Normal Incidence  
0.739,              !- Front Side Solar Reflectance at Normal Incidence  
0.738,              !- Back Side Solar Reflectance at Normal Incidence  
0.330,              !- Visible Transmittance at Normal Incidence  
0.566,              !- Front Side Visible Reflectance at Normal Incidence  
0.591,              !- Back Side Visible Reflectance at Normal Incidence  
0.0,                 !- Infrared Transmittance at Normal Incidence  
0.035,              !- Front Side Infrared Hemispherical Emissivity  
0.720,              !- Back Side Infrared Hemispherical Emissivity  
0.14,               !- Conductivity {W/m-K}  
1;                   !- Dirt Correction Factor for Solar and Visible Transmittance

CLEAR 6MM,           !- Name  
SpectralAverage,      !- Optical Data Type  
,                    !- Window Glass Spectral Data Set Name  
0.006,              !- Thickness {m}  
0.775,              !- Solar Transmittance at Normal Incidence  
0.071,              !- Front Side Solar Reflectance at Normal Incidence  
0.071,              !- Back Side Solar Reflectance at Normal Incidence  
0.881,              !- Visible Transmittance at Normal Incidence  
0.080,              !- Front Side Visible Reflectance at Normal Incidence  
0.080,              !- Back Side Visible Reflectance at Normal Incidence  
0.0,                 !- Infrared Transmittance at Normal Incidence  
0.84,               !- Front Side Infrared Hemispherical Emissivity  
0.84,               !- Back Side Infrared Hemispherical Emissivity  
0.9,                 !- Conductivity {W/m-K}

*Occupancy*

The table below lists the occupancy schedule for different areas in BLDG26. The maximum people for each zone can be found from the appendix D1.

Office		Conference		Classroom	
hours	fraction	hours	fraction	hours	fraction
6--7	0.1			7--9	0.8
7--8	0.2	10--11	0.5	9--10	0
8--12	0.95	11--2	0	10--12	0.8
12--1	0.5	2--3	0.5	12--1	0
1--5	0.95	3--10	0	1--3	0.8
5--6	0.3			3--4	0



6--10	0.1				4--6	0.8
10---12	0.05				6--7	0
12--6	0					

*Lighting*

The table below lists the lighting schedule for different areas in BLDG26. The lighting power density (W/m2) used for individual zones can be found from the appendix D1.

Conference		Classroom		Server room	
hours	fraction	hours	fraction	hours	fraction
		7--9	0.8		
10--11	0.5	9--10	0.15	10--11	0.8
11--2	0.1	10--12	0.8	11--2	0
2--3	0.5	12--1	0.15	2--3	0.8
3--10	0.1	1--3	0.8	3--10	0
		3--4	0.15		
		4--6	0.8		
		6--7	0.15		
weekend	0	weekend	0	weekend	0

Office LTG fraction

	Sep 1 to Apr 30		May 1 to Aug 31	
	weekday	weekend	weekday	weekend
1	0.28	0.26	0.16	0.15
2	0.28	0.26	0.16	0.15
3	0.28	0.26	0.16	0.15
4	0.28	0.26	0.16	0.15
5	0.28	0.26	0.16	0.15
6	0.30	0.26	0.25	0.15
7	0.69	0.26	0.57	0.15
8	0.73	0.26	0.61	0.15
9	0.93	0.26	0.73	0.15
10	0.99	0.26	0.79	0.15
11	1.00	0.26	0.82	0.15
12	1.00	0.26	0.83	0.15
13	1.00	0.26	0.85	0.15
14	1.00	0.26	0.85	0.15
15	1.00	0.26	0.85	0.15
16	1.00	0.26	0.85	0.15
17	0.91	0.26	0.66	0.15
18	0.74	0.26	0.37	0.15

19	0.54	0.26		0.19	0.15
20	0.39	0.26		0.15	0.15
21	0.39	0.26		0.15	0.15
22	0.38	0.26		0.15	0.15
23	0.28	0.26		0.15	0.15
24	0.27	0.26		0.15	0.15

*Equipment*

The table below lists the equipment schedule for different areas in BLDG26. The equipment power density ( $W/m^2$ ) used for individual zones can be found from the appendix A.

Conference		Classroom		Server room	
hours	fraction	hours	fraction	hours	fraction
10--11	0.8				
11--2	0.5	7--9	0.8		
2--3	0.8	9--10	0.5	24 hrs	1
3--10	0.5	10--12	0.8		
		12--1	0.5		
		1--3	0.8		
		3--4	0.5		
		4--6	0.8		
		6--7	0.5		
weekend	0	weekend	0		

Office Equipment fraction

	Sep 1 to Apr 30		May 1 to Aug 31	
	weekday	weekend	weekday	weekend
1	0.65	0.59	0.62	0.58
2	0.65	0.58	0.60	0.59
3	0.66	0.56	0.60	0.55
4	0.67	0.56	0.61	0.59
5	0.66	0.58	0.60	0.57
6	0.65	0.52	0.60	0.56
7	0.70	0.53	0.57	0.51
8	0.75	0.48	0.62	0.51
9	0.84	0.51	0.66	0.48
10	0.95	0.45	0.72	0.46
11	1.00	0.49	0.77	0.52
12	0.98	0.48	0.78	0.48
13	0.99	0.45	0.78	0.47
14	0.98	0.50	0.78	0.53
15	0.93	0.49	0.76	0.50

16	0.80	0.49		0.67	0.47
17	0.65	0.50		0.53	0.52
18	0.59	0.50		0.52	0.48
19	0.57	0.53		0.51	0.48
20	0.60	0.56		0.55	0.54
21	0.61	0.60		0.57	0.53
22	0.63	0.59		0.59	0.55
23	0.60	0.58		0.56	0.60
24	0.60	0.58		0.58	0.55

*DHW demand*

Domestic hot water is served to the building at maximum rate 2.25kg/s with an appropriate schedule. The domestic hot water supply temperature setpoint is 60°C .

*HVAC System Setup*

There are four variable volume air handler units in the Drill Hall. The static data for these four AHUs are listed in the table blow

	CFM	Cooling Coil							OA	SF TSP	RF TSP
		EAT(DB)	EAT(WB)	LAT(DB)	LAT(WB)	EWT	LWT	GPM	CFM	(IN)	(IN)
AHU1	9400	80	67	54.2	54	45	55	76.3	2000	4.48	0.75
AHU2	8400	80	67	54.2	54	45	55	67.6	2100	4.75	0.75

	Heating Coil						
	CFM	EAT(DB)	LAT(DB)	EWT	LWT	GPM	MBH
AHU1	9400	30	55	180	160	25.38	253.8
AHU2	8400	30	55	180	160	22.68	226.8

AHU operation schedule is listed as follows:

	Operation Schedule
AHU1	06:00 to 19:00 7 days a week
AHU2	06:00 to 19:00 7 days a week

*HVAC Zone Setup*

For the office area, each zone is model as a VAV with reheat coiling zone. Minimums and maximums are simulated as follows:

	Min CFM	Max CFM
VAVB_1	120	480
VAVB_2	165	250
VAV1.1	235	935

VAV1.2	125	490
VAV1.3	110	440
VAV1.4	130	520
VAV1.5	210	840
VAV1.6	125	490
VAV1.7	325	1300
VAV1.8	170	675
VAV1.10	110	430
VAV1.11	90	360
VAV1.12	125	500
VAV1.13	130	510
VAV1.14	85	330
VAV1.15	75	300
VAV2.1	165	650
VAV2.2	150	600
VAV2.3	75	300
VAV2.4	140	550
VAV2.5	165	650
VAV2.6	155	620
VAV2.7	160	625
VAV2.8	270	1075
VAV2.9	190	750
VAV2.10	110	230
VAV2.11	165	650
VAV2.12	320	1280
VAV2.13	230	910
VAV2.14	200	800
VAV2.15	200	800
VAV2.16	65	250
VAV2.17	175	700
VAV2.18	90	350
VAV2.19	100	400
VAV2.20	85	325
VAV2.21	50	160
VAV2.22	140	560

Thermostat schedules for all zones are as follows:

Cooling set point: 24.4°C occupied, 30°C unoccupied

Heating set point: 21.1°C occupied, 15°C unoccupied

#### *Building Water Distribution Loops*

The heating water distribution loop in the building is modeled as variable flow systems including variable speed drives on the pump. The chilled water distribution loop in the building is modeled as constant flow system include constant speed drive on the pump.

The chilled water loop is modeled with a set-point temperature of 7.2 °C. Pumps are modeled with premium efficiency motors.

The heating-water loop is modeled with a set-point temperature of 82.2°C. Pumps are modeled with premium efficiency motors.

Pump power consumption is described by the following part load performance curve

$$\text{FractionFullLoadPower} = C_1 + C_2\text{PLR} + C_3\text{PLR}^2 + C_4\text{PLR}^3$$

*Plant Energy Model*

One 53.3-ton air cooled chillers (Carrier 30RAN055---61PK) are used in the chiller plant. This chiller model is the empirical model used in the DOE-2.1 building energy simulation program. The model uses performance information at reference conditions along with three curve fits for cooling capacity and efficiency to determine chiller operation at off-reference conditions. Chiller performance curves are generated by fitting manufacturer’s catalog.

Cooling is available from April 15th to October 15th. Whenever outside air temperature is greater than 58°C, chiller will be turned on. Whenever outside air temperature is less than 56 °C, chiller will be turned off.

*Cooling Capacity Function of Temperature Curve*

A biquadratic performance curve parameterizes the variation of the cooling capacity as a function of the leaving chilled water temperature (x) and the entering condenser fluid temperature (y). The output of this curve is multiplied by the reference capacity to give the cooling capacity at specific temperature operating conditions (i.e., at temperatures different from the reference temperatures).

```

ChillerCapFT1,      !- Name
-1.97711,           !- Coefficient1 Constant
0.0461,             !- Coefficient2 x
0.00095,           !- Coefficient3 x**2
0.16093,           !- Coefficient4 y
-.00226,           !- Coefficient5 y**2
-.00079,           !- Coefficient6 x*y
5,                 !- Minimum Value of x
10.0,              !- Maximum Value of x
12,                !- Minimum Value of y
50,                !- Maximum Value of y

```

*Electric Input to Cooling Output Ratio Function of Temperature Curve*

A biquadratic performance curve parameterizes the variation of the energy input to cooling output ratio (EIR) as a function of the leaving chilled water temperature (x) and the entering condenser fluid temperature (y). The EIR is the inverse of the COP. The output of this curve is multiplied by the reference EIR (inverse of the reference COP) to give the EIR at specific temperature operating conditions (i.e., at temperatures different from the reference temperatures).

```

ChillerEIRFT,      !- Name

```

-1.10284,      !- Coefficient1 Constant  
 -.00466,       !- Coefficient2 x  
 0.00095,      !- Coefficient3 x\*\*2  
 0.09616,      !- Coefficient4 y  
 -.00085,      !- Coefficient5 y\*\*2  
 -.00088,      !- Coefficient6 x\*y  
 5.0,           !- Minimum Value of x  
 10.0,          !- Maximum Value of x  
 12,            !- Minimum Value of y  
 50,            !- Maximum Value of y

Electric Input to Cooling Output Ratio Function of Part Load Ratio Curve

A quadratic performance curve parameterizes the variation of the energy input ratio (EIR) as a function of the part-load ratio. The EIR is the inverse of the COP, and the part-load ratio is the actual cooling load divided by the chiller's available cooling capacity. The output of this curve is multiplied by the reference EIR (inverse of the reference COP) and the Energy Input to Cooling Output Ratio Function of temperature Curve to give the EIR at the specific temperatures and part-load ratio at which the chiller is operating.

ChillerEIRFPLR1,   !- Name  
 0.6741,           !- Coefficient1 Constant  
 -.4959,           !- Coefficient2 x  
 0.8187,           !- Coefficient3 x\*\*2  
 0.25,             !- Minimum Value of x  
 1.5;              !- Maximum Value of x

Appendix D1:

	Zone Name	Rooms	VAV box	AHU	Floor Area (m2) E+ Zones*	Used in E+ Internal Wall Area (m2)	Used in E+ model Furnishing Area (m2)	Used in E+ model Estimate of Max People	Used in E+ model Lighting (W)	Lighting (W/ m-2)	Equipment (W)	Not Used in E+ model Equipment (W m-2)	Used Design intent W/m-2
15407	FL1_ZN1	117, 118, 120, 122, 124	VAV1.1	AHU1	70.24		49.16	4	400	5.70	1360	19.36	14
15389	FL1_ZN2	Lounge 116, 119, 121, 123 125	VAV1.2	AHU1	52.47		36.73	4	400	7.62	1360	25.92	14
15288	FL1_ZN3	127	VAV1.3	AHU1	33.45		23.41	2	300	8.97	4718	141.07	30
15356	FL1_ZN4	126, 128, 129, 130	VAV1.4	AHU1	71.68		50.17	3	300	4.19	1020	14.23	14
15316	FL1_ZN5	Conf 131	VAV1.5	AHU1	33.45		23.41	2	100	2.99	690	20.63	14
15399	FL1_ZN6	132, 134, 136, 138, 140	VAV1.6	AHU1	64.59		45.21	4	400	6.19	1360	21.06	14
15347	FL1_ZN7	133, 135, 137	VAV1.7	AHU1	31.99		22.40	3	300	9.38	1140	35.63	14
15339	FL1_ZN8	139, 141	VAV1.8	AHU1	21.84		15.29	2	200	9.16	680	31.13	14
15367	FL1_ZN9	102, 104, 105	VAV 1.10	AHU2	58.81		41.17	1	204	3.47	620	10.54	14
15377	FL1_ZN10		VAV 1.11	AHU2	46.45		32.52	1	50	1.08	300	6.46	14
15324	FL1_ZN11	restroom 109, 110, 111 112	VAV 1.12	AHU2	68.38		47.86	1	300	4.39	300	4.39	14
15302	FL1_ZN12	vender 114	VAV 1.13	AHU2	27.59		19.31	1	200	7.25	815	29.54	20
15295	FL1_ZN13	113	VAV 1.14	AHU2	22.58		15.80	1	100	4.43	300	13.29	14
15309	FL1_ZN14	115	VAV 1.15	AHU2	23.41		16.39	1	100	4.27	330	14.10	14
15272	FL1_ZN15	101	VAV_B.1	AHU2	36.95		25.87	2	200	5.41			
15265	FL1_ZN16	Stair S2	CUH1		22.41								
15281	FL1_ZN17	Stair S3	CUH2		22.39								
15415	FL1_ZN18	Elevator			12.36						5000	404.66	
15256	FL1_ZN19	not included			379.70		265.79						
23319	FL2_ZN1	classroom 207208	VAV 2.1	AHU1	63.87		44.71	5	300	4.70	480	7.52	10
23346	FL2_ZN2	211,213	VAV 2.2	AHU1	39.60		27.72	4	300	7.58	1270	32.07	14
23328	FL2_ZN3	209,210,212	VAV 2.3	AHU1	39.60		27.72	1	150	3.79	520	13.13	14
23196	FL2_ZN4	215,216,217	VAV 2.4	AHU1	42.10		29.47	3	250	5.94	1500	35.63	14
23258	FL2_ZN5	Off + restroom 214,218, 219, 220, 221,222	VAV 2.5	AHU1	77.196		54.04	2	400	5.18	4100	53.11	20
23239	FL2_ZN6	Lounge 223	30 AHU1		19.933		13.95	2	200	10.03	3934	197.36	30
23301	FL2_ZN7	224,225	VAV 2.7	AHU1	23.271		16.29	2	200	8.59	680	29.22	14
23293	FL2_ZN8	226,227	VAV 2.8	AHU1	39.159		27.41	3	200	5.11	1200	30.64	14
23286	FL2_ZN9	meeting room 228	VAV 2.9	AHU1	31.216		21.85	4	200	6.41	320	10.25	14
23182	FL2_ZN10	vestibule 201	VAV 2.10	AHU2	36.955		25.87	1	100	2.71			
23308	FL2_ZN11	234, 235, 236, 202, 203, 204, 205 206	VAV 2.11	AHU2	112.413		78.69	2	400	3.56	730	6.49	14
23231	FL2_ZN12	Classroom 229, 231, 232,	VAV 2.12	AHU2	87.793		61.46	3	500	5.70	960	10.93	10
23223	FL2_ZN13	Conference 233	VAV 2.13	AHU2	59.365		41.56	13	350	5.90	1510	25.44	14
23278	FL2_ZN14	Reception 237	VAV 2.14	AHU2	39.028		27.32	1	100	2.56	450	11.53	14
23269	FL2_ZN15	238, 239, 240, 241	VAV 2.15	AHU2	84.102		58.87	3	350	4.16	300	3.57	14
23214	FL2_ZN16	Bathroom 243, 244	VAV 2.16	AHU2	15.76		11.03	0	108	6.85	300	19.04	14
23246	FL2_ZN17	Conference 242, 245, 246	VAV 2.17	AHU2	59.696		41.79	4	260	4.36	3484	58.36	14
23206	FL2_ZN18	248	VAV 2.18	AHU2	25.585		17.91	1	200	7.82	410	16.03	14
23163	FL2_ZN19	250, 251, 252	VAV 2.19	AHU2	52.652		36.86	1	384	7.29	200	3.80	14
23368	FL2_ZN20	253	VAV 2.20	AHU2	17.71		12.40	1	180	10.16	100	5.65	14
23375	FL2_ZN21	253, 254	VAV 2.21	AHU2	24.741		17.32	2	150	6.06	480	19.40	14
23336	FL2_ZN22	255, 256	VAV 2.22	AHU2	49.494		34.65	2	200	4.04	400	8.08	14
23361	FL2_ZN23	Stair S1			10.927								
23175	FL2_ZN24	Stair S2			22.412								
23189	FL2_ZN25	Stair S3			22.388								
23354	FL2_ZN26	Stair S4			3.75								
22645	FL0_ZN1	Maintenance 001	VAV_B.2	AHU2	8.919		6.24	1	400				14
22638	FL0_ZN2	Mech006	UH1, UH2		143.071							6.0878864	
22631	FL0_ZN3	Firepump	UH4		33.445								
22624	FL0_ZN4	Mech005	UH3		22.575								
22617	FL0_ZN5	Telcom007	ACC		20.067								30
22590	FL0_ZN6	Others			580.83		493.71						
22579	FL0_ZN7	no part			291.81		204.26						

## Appendix E: BLDG26 EnergyPlus Model Calibration and Verification

This document summarizes the calibration and validation work performed on the EnergyPlus model of DOD Fleet and Family Support Center (Building 26). Originally, an EnergyPlus model was created of the building and selection of its 2063 parameters was performed using the best information that was available at the time. In this work, a subset of these parameters was identified using sensitivity analysis and subsequently automatically tuned so that the model better matches data. Model calibration was performed using sensor data for one year, and the output of the model was then compared to sensor data for a few months in a year in which the model was not specifically tuned to match (model verification).

### Approach

The model calibration process relies heavily on characterizing parametric influences on the outputs of the model. This analysis is performed by sampling all parameters of the model around their nominal value to create a database of output data which is used to calculate the sensitivity of these outputs to parameter variation as well as to derive an analytic meta-model based on this model data. Once the most influential parameters of the model are identified, optimization can be performed (using the meta-model) in order to identify which parameter combinations produce the best fit to data. A schematic of this process is presented in Figure 1, while each step is described in further detail below.

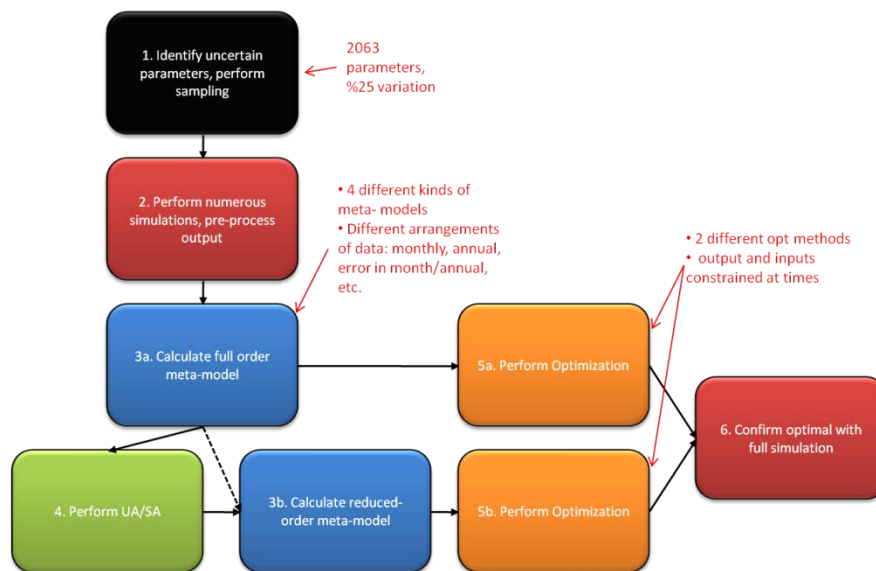

Figure 1 Schematic of the calibration process

### Available Data

Predominate historical data included utility meters for total building electricity, plug load electricity and steam usage (additional sensors were in the process of being added to meter subsystems within the building during the project). This data had been recorded for 2009, 2010, and part of 2011. Of this data, it was decided that there was significant uncertainty in the steam data, leaving plug and total electricity for analysis. Of this, it was decided to investigate how well the model could be tuned to predict plug and total electricity for 2010 (Figure 2). The calibrated model was then compared with data for a few months in 2011 to quantify its predictive capability.



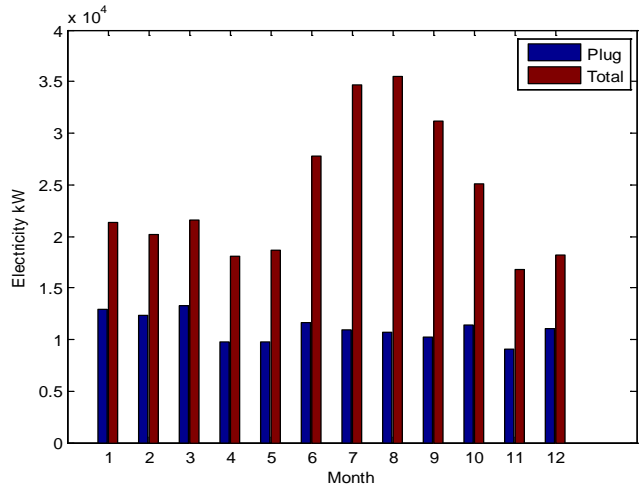

Figure 2 Raw sensor data taken from 2010 used for calibration of the EnergyPlus Model

### Uncertainty and Sensitivity Analysis

The purpose of the uncertainty and sensitivity analysis is to identify which of the entire list of parameters are best to use for calibration purposes. In order to do this, a list of the parameters and their nominal values is collected and a range is then created which spans +/- 25% of the nominal value using a uniform distribution if the nominal value is nonzero and an exponential distribution otherwise. Sixty five hundred samples are created in this range, which are concurrently perturbed using a deterministic sampling approach. The EnergyPlus models associated with these samples are then simulated in parallel to generate output data for each of these instances (further detail on the sampling approach may be found in [1]).

Once the output data is generated, sensitivity analysis is performed to rank-order the parameters in terms of their influence on the output. The sensitivity indices for each output and for each month of sensor data were calculated. An example of the sensitivity calculation for total electricity in March is presented in Figure 3. In this figure, all 2063 sensitivity indices are plotted while the top 10 most influential parameters that influence total electricity in March are highlighted in the legend.

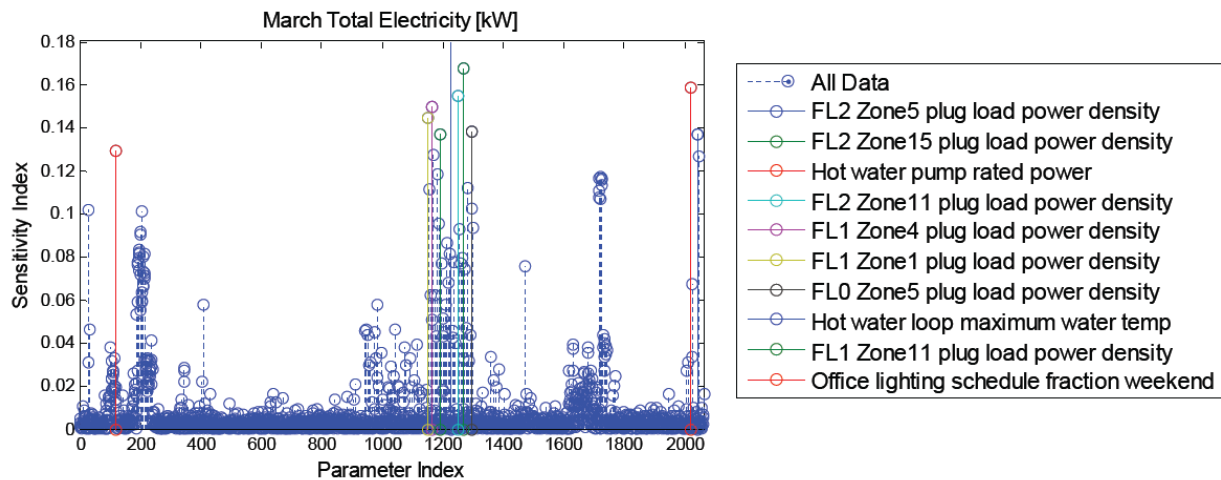
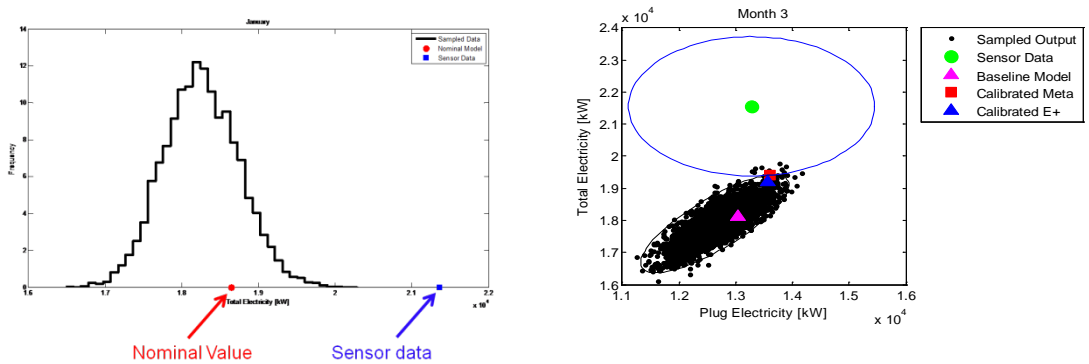

Figure3 Sensitivity indices for March total electricity illustrating the top ten parameters that influence this model output.

### Optimization (Calibration)

To perform the actual calibration, a mathematical optimization problem is defined in which parameters are varied in order to minimize the difference between the model output and sensor data. Optimization using whole-building energy models is often challenging due to the computationally expensive nature of the simulation as well as discontinuities that are often found in the cost surface [3]. In order to circumvent these issues, an analytic model of the full EnergyPlus model (meta-model) is created using a machine learning regression technique (see [2] for details).

With an analytic representation of the building dynamics, rapid optimization is performed on the meta-model using an interior point method and confirmed using the full EnergyPlus model. Since the function evaluation is so rapid, optimization experiments can be performed with thousands or just a few key parameters of the model. In order to perform the optimization, a cost function is defined as



used for the calibration. It should be noted that these results are from optimization with output constraints and the error can be reduced if these constraints are lifted. These constraints can be lifted by moving the cloud of sampled data (with which the meta-model is derived) closer to the sensor data. This can be done by either larger perturbations on the sampled input, or by moving the nominal value closer to the sensor data.

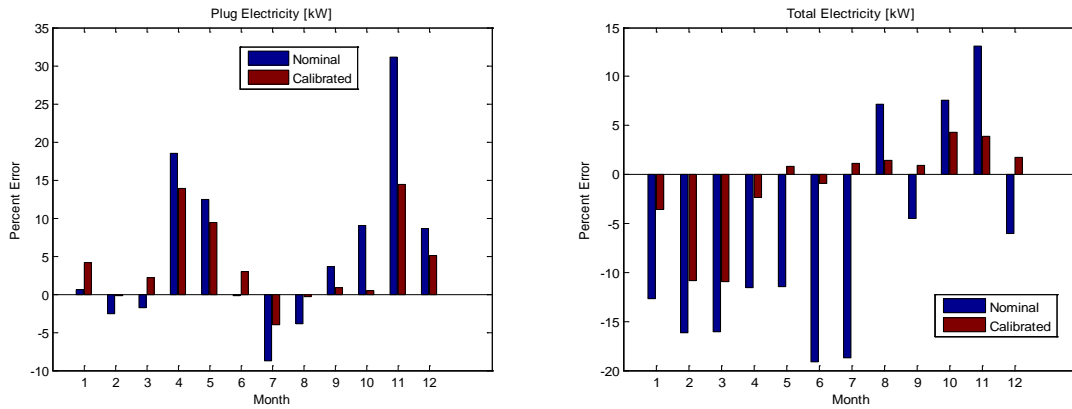

Figure 5 Calibration results for each month in 2010.

### Validation

The above calibration process illustrates how well a model can be tuned to fit a pre-described sensor data set. Once the model is calibrated it is desirable for the model to have prediction capability for future data. This validation process was performed using three months of data from 2011 (recall that the model was calibrated for 2011 data) and presented in Figure 6. This image illustrates that the error in prediction using the calibrated model (Verification with 2011 weather in the figure) is respectable and better than the un-calibrated model (Nominal with 2011 weather in the figure). There is a significant error in the month of May which is due to a chiller failure (confirmed with facility team), which did not occur when the model was calibrated. In a sense, this verification test for this month illustrated an unexpected excursion in the data due to an equipment fault which is predicted by the validated model.

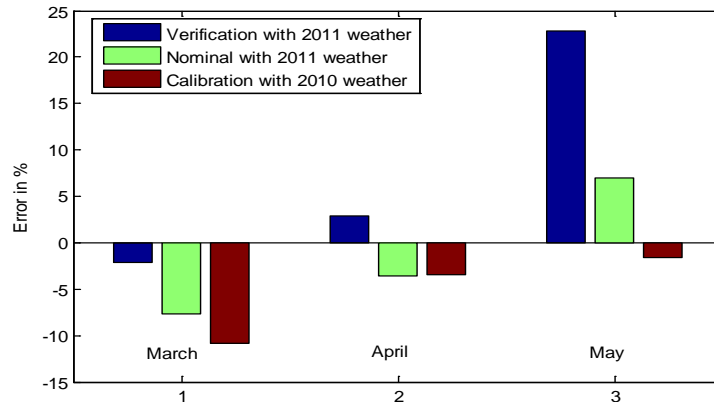

Figure 6 Verification results for 2011

### References

1. Eisenhower, B., O'Neill, Z., Fonoberov, V. A., and Mezic, I., 2011, "Uncertainty and sensitivity decomposition of building energy models," *Journal of Building Performance Simulation*, Available Online, In Press.
2. Eisenhower, B., O'Neill, Z., Narayanan, S., Fonoberov, V. A., and Mezic, I., 2011b, "A methodology for meta-model based optimization in building energy models," Submitted.
3. Wetter, M. and Wright, J., 2003, "Comparison of a generalized pattern search and a genetic algorithm optimization method," in *Proceedings of the Eighth International IBPSA Conference*, Eindhoven, Netherlands, pp. 1401–1408.

## Appendix F: Load Estimation

The load estimation algorithm [1] was adapted for the purpose of estimating the unknown building lumped internal load from the available model and measurements. The internal load herein comprises of plug, occupancy and lighting loads. The system model was augmented with states defining the internal load and driven with white noise. The extended Kalman filter is then employed to estimate the load. Please refer to [1] for more details on the filter. Figures 1 and 2 show estimated internal heat gains for one sub thermal zone in Drill Hall.

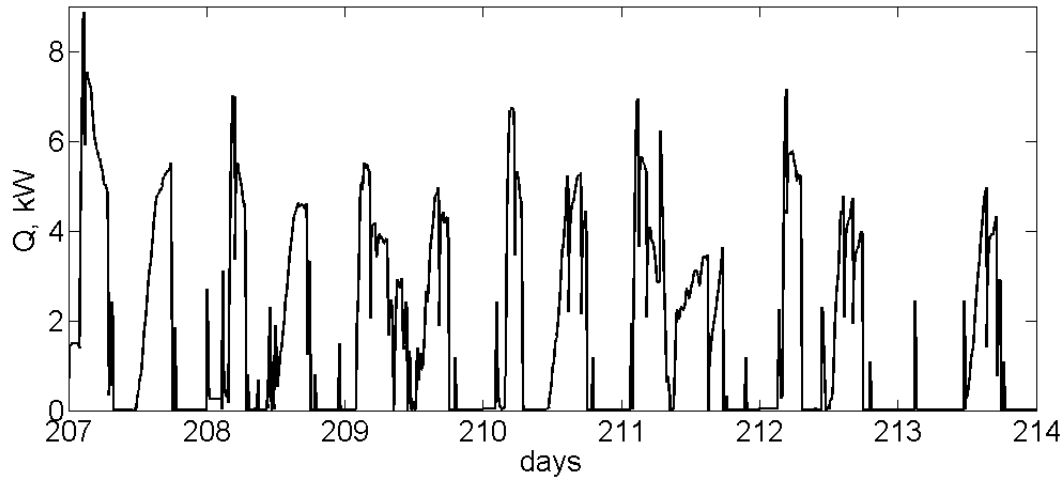

Figure 1 Estimated heat gains from July 1 to July 7, 2010

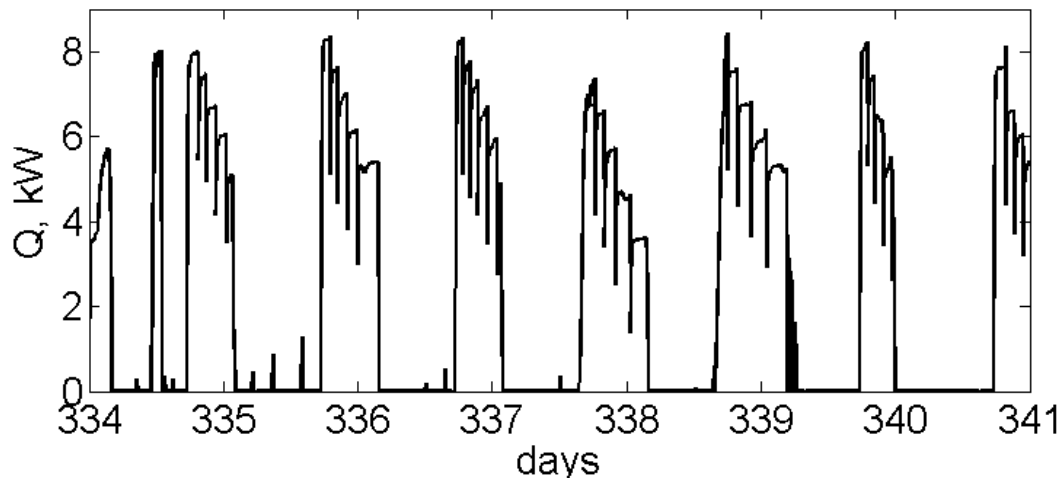

Figure 2 Estimated heat gains from Dec 1 to Dec 7, 2010

### Reference

1. O'Neill, Z., Narayanan, S. and Brahme, R. 2010. Model-based Thermal Load Estimation in Buildings, Proceedings of SimBuild 2010. New York City, NY. IBPSA-USA.

## Appendix F: Automated Continuous Commissioning Tool GUI Screenshots from the Demonstration

In this appendix, a few screenshots from the demonstration in Building 26 are presented. Selected time range is from September 1<sup>st</sup> 2011 to September 7<sup>th</sup> 2011.

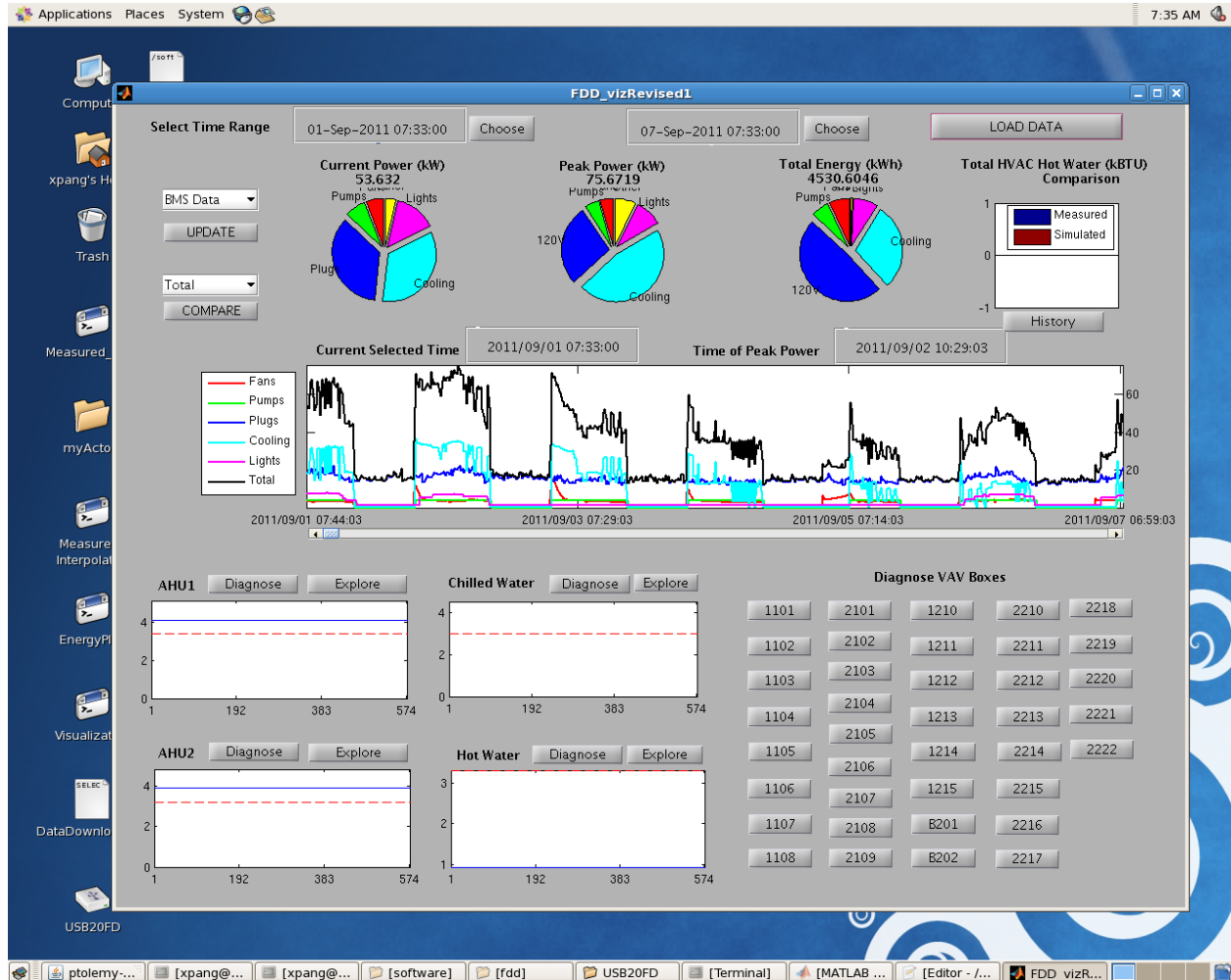

Figure 1 Energy and diagnostics visualization main GUI in Building 26 demonstration

The diagnostics plots on the left bottom shows that AHU1 and AHU2 have potential issues and chilled water system was working fine. Deep-dive diagnostics (shown in the following figures) illustrate that high discharge air temperatures in AHUs caused large anomaly scores.

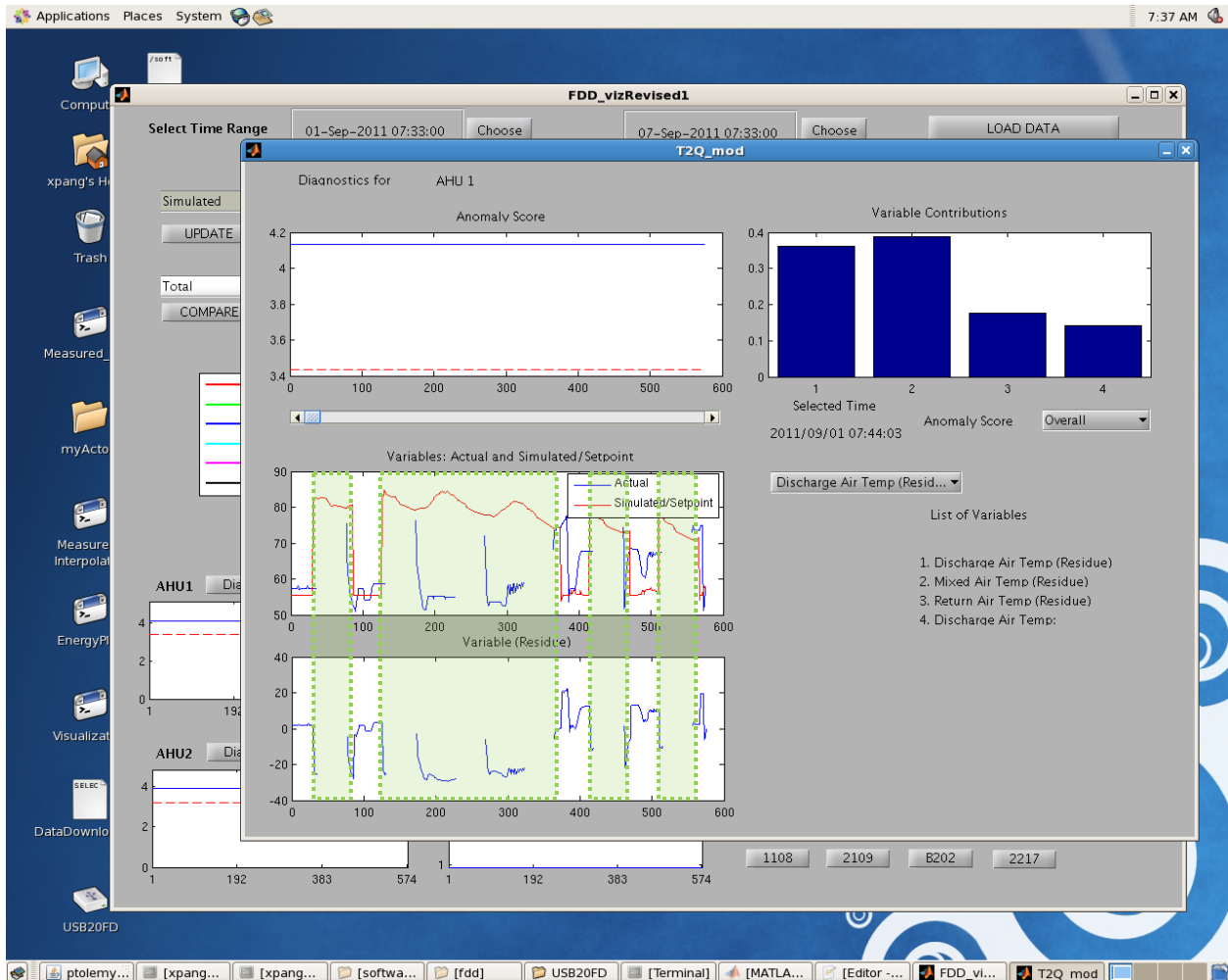

Figure 2 AHU1 energy diagnostics visualization in Building 26 demonstration

AHUs were scheduled to be off in unoccupied hours (night, weekend and holidays) in the reference EnergyPlus model. The simulated discharge air temperature (in red) has no meaning for these hours which are marked with green rectangle. By looking at the discharge air temperature residuals from weekdays (non green rectangular area), there are deviations up to 20F. These deviations cause the anomaly score beyond the threshold. In cooling season, the higher discharge air temperature does not bring any detrimental impact on the cooling energy consumption while the zones serving by this AHU probably will have some thermal comfort issues.

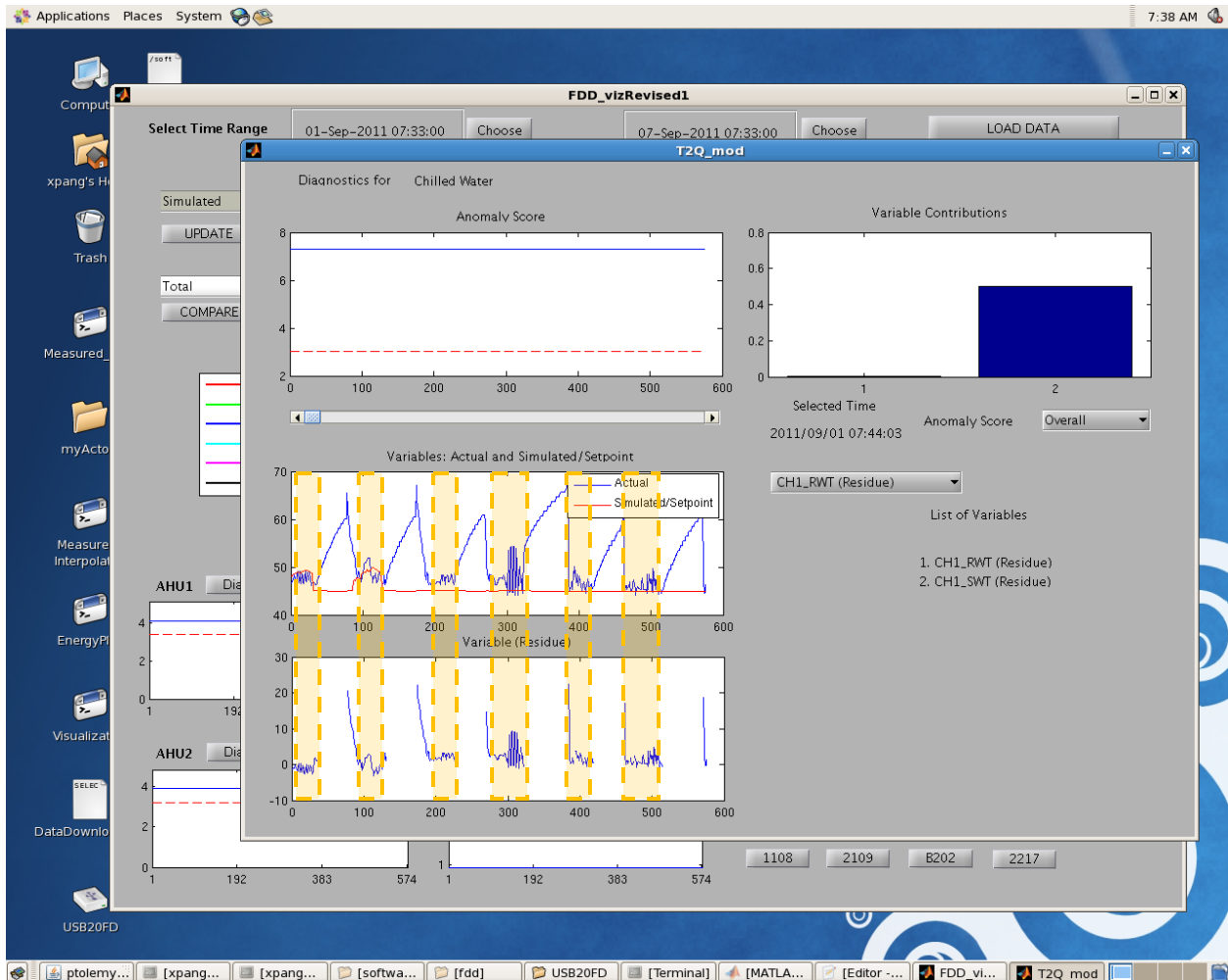

Figure 3 Chiller energy diagnostics visualization in Building 26 demonstration

The period marked with yellow rectangles represent hours whenever the chiller is on. For these hours, There are some differences between model predicted temperatures and actual measurements. It was found out that the actual supply water temperature setpoint is higher than setpoint used in the design intent model. Higher supply water temperature actually will save the chiller electricity consumption.



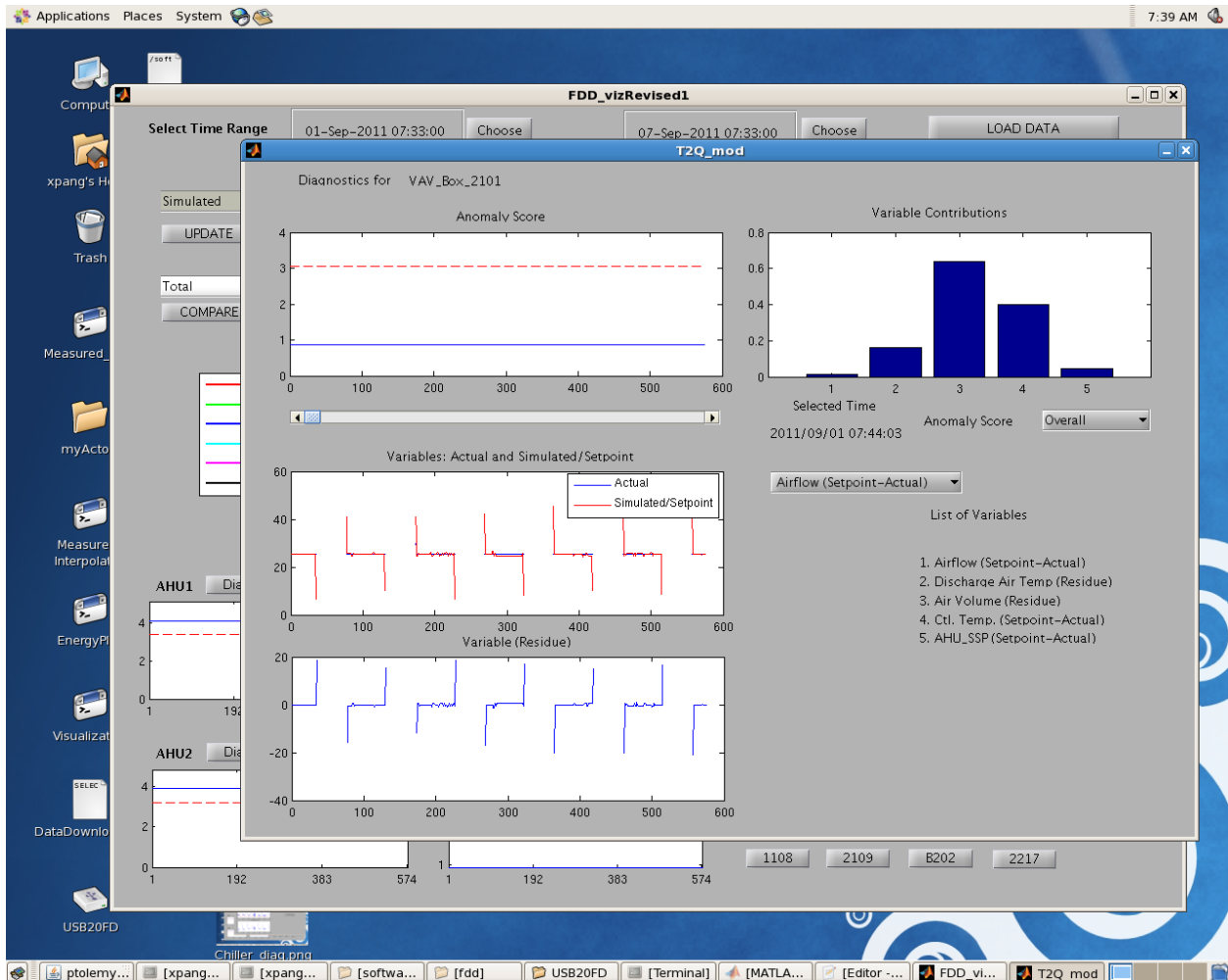

Figure 4 VAV box energy diagnostics visualization in Building 26 demonstration

This VAV box was operating normally during the selected period.

## Appendix H: Response to ESTCP IPR Action Items

*ESTCP IPR Action Item 1: Building 1491 was eliminated as a candidate demonstration site based on its size and HVAC configuration. This implies certain limitations of your models and the applicability of the proposed technology to portions of DoD's building stock. Please expand on what the specific limitations are and how much of DoD's building stock may be affected and plan to address these limitations in your Final and Cost and Performance Reports. In addition, your Final and Cost and Performance Reports ultimately will have to address the need for building specific weather stations as an implementation issue that may affect the economics of the technology.*

A detailed evaluation of Building 1491 eliminated it as a candidate for the following primary reasons:

- The building is small (about 17,000ft<sup>2</sup>)
- The building HVAC system, which consists of 25 water source heat pumps could not easily be modeled accurately in the version of the proposed simulation platform (EnergyPlus) available at the time.

### Building size issue

The DoD building stock database was examined to understand building size and HVAC configuration from all the buildings in the U.S. There are total 247,205 buildings in the U.S. After filtering out buildings that are not permanent facility and not actively used, this number becomes 62,508. Among these buildings, there are 42,438 buildings (68%) with footage less than 8,000 ft<sup>2</sup>. Most of them are garage, ammunition, flammable storage and residential family houses. Since the focus of this project is commercial buildings with DDC systems, these small buildings were not included in this stock analysis.

If we look at permanent DoD buildings with floor areas greater than 8,000 ft<sup>2</sup> that are in active use, 49% of these buildings are between 8,000 ft<sup>2</sup> and 20,000 ft<sup>2</sup>, the remaining 51% are larger than 20,000 ft<sup>2</sup>.

### HVAC configuration issue

EnergyPlus is supported by DOE and has two major releases every year. The current release version (6.0) does not set water flow rates properly when water source heat pumps have zero load. Comprehensive plant improvements are underway to address this in the near future by EnergyPlus development team. Based on the data provided by ESTCP project SI-1709, only 5.8% of all DoD buildings are using heat pumps for both heating and cooling. Assuming that half of these heat pumps are water source (including ground source) heat pumps, there will be only less than 3% of DoD buildings with water source heat pumps.

In this project, the expected benefits were calculated based on the assumption that the automated continuous commissioning system will apply in 10% of DoD facility.

### Weather station issues

Weather station issues are being addressed in Section 7. A summary is provided as following:

Building simulation programs used for real time estimation of building loads and conditions rely on pre-established parameters and real-time information of operating conditions. This information may include internal conditions (e.g. occupancy, room temperature and humidity,

light levels within the building, etc.) and weather conditions (e.g. solar radiation, external temperature and humidity, wind speed and direction).

The demonstration site for this project is Naval Station Great lakes, where currently it is not possible to have real-time access to weather data via internet due to IT security issues at the base. A pyranometer<sup>13</sup> capable of measuring the total solar radiation and diffuse solar radiation at the same time with an accuracy of  $\pm 2\%$  was installed. The accurate measurement of real time solar radiation is required as it is one of the most important thermal boundary conditions for most of existing buildings across the DoD facilities.

When the technology is commercially deployed, there are a few options that can be considered for weather station cost reduction:

1. If internet access is available, weather data taken directly from the NOAA website (National Oceanic and Atmospheric Administration) can be utilized without the need for installing a weather station. NOAA provides the required weather data for most locations in the United States. However, it has been noticed that solar radiation data are not present in the NOAA database for all locations (e.g.). In those specific cases, information from local weather stations will be required.
2. If internet access is not available (as is currently the case at Naval Station Great Lakes) a weather station will be required.
3. Multiple buildings on one campus will be able to share one weather station with the necessary network setup if access is available to a base intranet or if a wireless network is available.
  - a. If the base has an existing weather station, weather data can potentially be used directly from this existing weather station, with consideration for data accuracy and reliability.
  - b. If there is no existing weather station on the base, a single weather station can be installed and weather data can be shared among buildings across the base.

*ESTCP IPR Action Item 2: As part of your Final and Cost & Performance Reports, plan to include the following:*

- a. a determination of and associated justification for the minimum data set required to monitor adequate meteorological information and how many meteorological stations might be required to meet these data needs for a typical installation.*
- b. a description of the level of expertise and training needed to implement the technology.*

#### Meteorological data issue

Real time weather data from an on-site weather station including solar radiation data are essential to reduce model prediction error. Statistical TMY3 weather data sometimes could cause the model predictions to significantly deviate from measured data. For the July 2010, the average difference between measured outside air temperature and TMY3 data is about 5.4°F (3°C), and maximum difference is about 23°F (12.75°C).

---

<sup>13</sup> [www.irradiance.com](http://www.irradiance.com) rotating shadow band radiometer (RSR2)

Pyranometer: A pyranometer is not typically used in the building industry and most market available pyranometers only measure the global (total) solar radiation. However, the beam and diffuse components of the global solar radiation are required to simulate the building performance properly in whole building simulation programs.

Temperature and relative humidity sensor: Outside air temperature and humidity are weather variables with the most influence on the performance of typical commercial buildings. Modern buildings equipped with an EMCS commonly have the outdoor dry bulb temperature and relative humidity measurements available. They can be used directly by the technology. However, care needs to be taken to ensure that existing sensors are calibrated and properly located to provide reasonable measurements.

Wind speed and direction sensor: The wind speed and direction will affect the building external convective heat transfer coefficient as well as the infiltration rate and will impact the building energy performance.

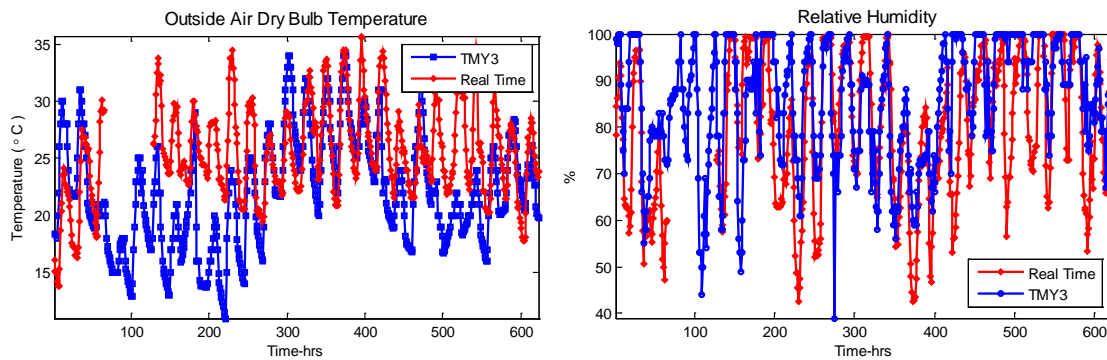

Figure 1 Outside air temperature and relative humidity from onsite weather station and TMY3 data

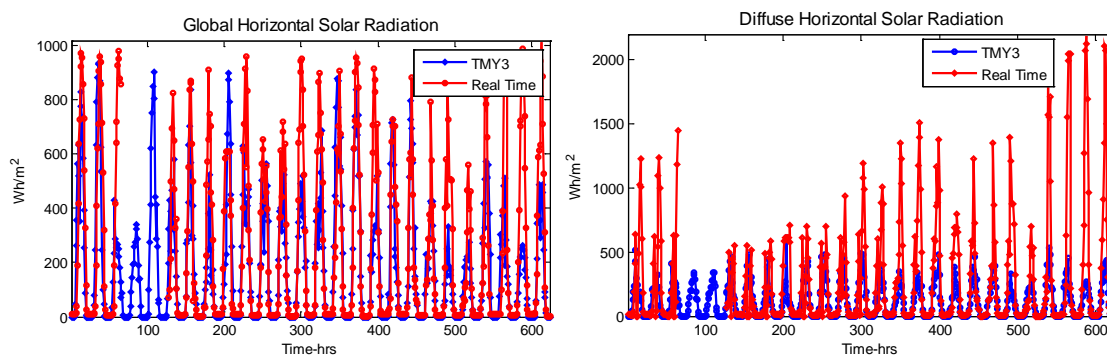

Figure 2 Solar radiation flux from onsite weather station and TMY3 data

The issue related to number of weather station is addressed in the responses to first action item.

Training issue

Using this Automated Continuous Commissioning Tool currently requires the user to have the following skills:

- **Create an EnergyPlus model.** EnergyPlus, developed by Department of Energy (DOE), is a whole building energy simulation program that engineers, architects, and researchers use to model energy and water use in buildings. Modeling the performance of a building with EnergyPlus enables building professionals to optimize the building design to use less energy and water. DOE regularly provides training on how to use EnergyPlus. Also, the Appendices B and C provide detailed descriptions of EnergyPlus model for demonstration buildings used in the project. The current development of a comprehensive graphical user interface (GUI) for EnergyPlus by a team led by LBNL [19] will make a number of different aspects of modeling buildings, including existing buildings, simpler, faster and less prone to error.
- **Use of the BCVTB.** BCVTB is an open source software platform for building data acquisition, and the integration of real time data and EnergyPlus model. The BCVTB makes use of Ptolemy II [8], an open source software environment for combining heterogeneous modeling and simulation tools. A detailed description of steps to use BCVTB is provided in section 2.0.

*ESTCP IPR Action Item 3: In your Final and Cost & Performance Reports, describe lessons learned from your site visits to the Great Lakes facility and your discussions with its maintenance personnel.*

During the whole demonstration period, the team made 7 visits to the Great Lakes facility. The team had a real time demonstration with the facility team in October, 2011.

Feedbacks from facility team are included in section 8.

A few highlights from the site visits are listed as following:

- Control logics in the control submittal may not be the ones actually implemented in the real building.
- Valves position (cooling coil and heating oil) has to be combined with associated pumps and system status to give meaningful diagnostics.
- COV (change of value) for power meter for small size pumps and fans need to be adjusted to 0.1 kW.
- Building 26 plug load electricity consumption is 50% to 60% of total electricity consumption. The root cause for this high plug load is due to occupant behavior related to the use of personal heaters, microwaves, toasters and computers never being shut down. Real time plug load plots were well received by the Great Lakes energy manager and used to illustrate the impact of occupant behavior on the energy consumption.
- Internet access is critical for both cost reduction and tool development.
- Building as-built drawings, control submittals, operation and maintenance records are very important to develop the energy models.
- Facility team found the energy usage visualization tool to be helpful as it enabled them to monitor impacts of control changes they made on energy consumption.
- It is desirable to have a centralized BMS on the base, so the facility team member can remotely access the automated continuous commissioning system sitting in each building. Ideally, only one PC is needed to host the automated continuous commissioning system in the centralized BMS.