

# **Evaluation of Alternative Field Buses for Lighting Control Applications**

**Prepared By:**

Ed Koch, Akua Controls

**Edited By:**

Francis Rubinstein, Lawrence Berkeley National  
Laboratory

**Prepared For:**

Broadata Communications  
Torrence, CA

March 21, 2005

# Table of Contents

Introduction.....	3
<b>Purpose .....</b>	<b>3</b>
<b>Statement of Work .....</b>	<b>3</b>
1-Wire Net .....	4
<b>Introduction and Background.....</b>	<b>4</b>
<b>Technical Specifications.....</b>	<b>5</b>
<b>Description of Technology.....</b>	<b>5</b>
<b>Practical Considerations .....</b>	<b>7</b>
<b>Available Devices .....</b>	<b>7</b>
<b>Standards and Trade Organizations .....</b>	<b>11</b>
<b>Companies.....</b>	<b>11</b>
MODBUS .....	15
<b>Introduction and Background.....</b>	<b>15</b>
<b>Technical Specifications.....</b>	<b>15</b>
<b>General Protocol Description.....</b>	<b>16</b>
<b>Serial Implementation .....</b>	<b>20</b>
<b>MODBUS OVER TCP/IP .....</b>	<b>20</b>
<b>Standards and Trade Organizations .....</b>	<b>22</b>
<b>Companies.....</b>	<b>22</b>
ZigBee.....	23
<b>Introduction and Background.....</b>	<b>23</b>
<b>Technical Specifications.....</b>	<b>24</b>
IEEE 802.15.4.....	25
<b>ZigBee Protocol .....</b>	<b>30</b>
<b>ZigBee Application Profiles .....</b>	<b>31</b>
<b>Standards and Trade Organizations .....</b>	<b>32</b>
<b>ZigBee.....</b>	<b>32</b>
<b>IEEE 802.15.4 .....</b>	<b>33</b>
<b>IEEE 1451.5 .....</b>	<b>33</b>
<b>Companies.....</b>	<b>34</b>
DALI.....	36
<b>Introduction and Background.....</b>	<b>36</b>
<b>Technical Specifications.....</b>	<b>36</b>
<b>General Characteristics.....</b>	<b>36</b>
<b>DALI Communications Description.....</b>	<b>38</b>
<b>Standards and Trade Organizations .....</b>	<b>41</b>
<b>Companies.....</b>	<b>42</b>

Synopsis and Comparisons .....	42
Appendices – Company profiles .....	44
<b>Appendix A - MODBUS Technology Companies .....</b>	<b>44</b>
<b>Appendix B – ZigBee Technology Companies .....</b>	<b>51</b>
<b>Promoter Companies .....</b>	<b>51</b>
<b>Participant Companies .....</b>	<b>53</b>
<b>Appendix C – DALI Technology Companies .....</b>	<b>81</b>

## Introduction

### Purpose

This document is a report prepared in fulfillment of Task 1 of the Subcontract Statement of Work between Lawrence Berkeley National Laboratory and Broaddata Communications, Inc. The statement of work that covers the requirements for this report is included in the following section.

### Statement of Work

The Subcontract Statement of Work consists of two major tasks. This report is the Final Report in fulfillment of the contract deliverable for Task 1. The purpose of Task 1 was to evaluate existing and emerging protocols and standards for interfacing sensors and controllers for communicating with integrated lighting control systems in commercial buildings. The detailed task description follows:

#### *Task 1. Evaluate alternative sensor/field buses*

The objective of this task is to evaluate existing and emerging standards for interfacing sensors and controllers for communicating with integrated lighting control systems in commercial buildings. The protocols to be evaluated will include at least: 1) 1-Wire Net, 2) DALI 3) MODBUS (or appropriate substitute such as EIB) and 4) ZigBee. The evaluation will include a comparative matrix for comparing the technical performance features of the different alternative systems. The performance features to be considered include: 1) directionality and network speed, 2) error control, 3) latency times, 4) allowable cable voltage drop, 5) topology, and 6) polarization. Specifically, Subcontractor will:

- Analyze the proposed network architecture and identify potential problems that may require further research and specification.
- Help identify and specify additional software and hardware components that may be required for the communications network to operate properly.
- Identify areas of the architecture that can benefit from existing standards and technology and enumerate those standards and technologies.
- Identify existing companies that may have relevant technology that can be applied to this research.
- Help determine if new standards or technologies need to be developed.

# 1-Wire Net

## Introduction and Background

The 1-wire network was originally developed by Dallas Semiconductor (now Maxim) as a bus for building simple, low cost devices that can communicate with PCs or microcontrollers. It is sometimes marketed under the name of MicroLAN. It derives its name from the fact that all communications are done over a single wire (although in reality the cable consists of a twisted pair in which one of the conductors is the return or ground wire).

Maxim sells a suite of chips that allows one to build a variety of node types depending upon their requirements. Each of these chips are low cost and allow a specific type of node to be designed.

Organizations such as the Berkeley Lab have embraced the 1-wire technology and incorporated it into their architectures such as IBECS.<sup>1</sup> Below is a diagram of the IBECS network that utilizes 1-wire technology.

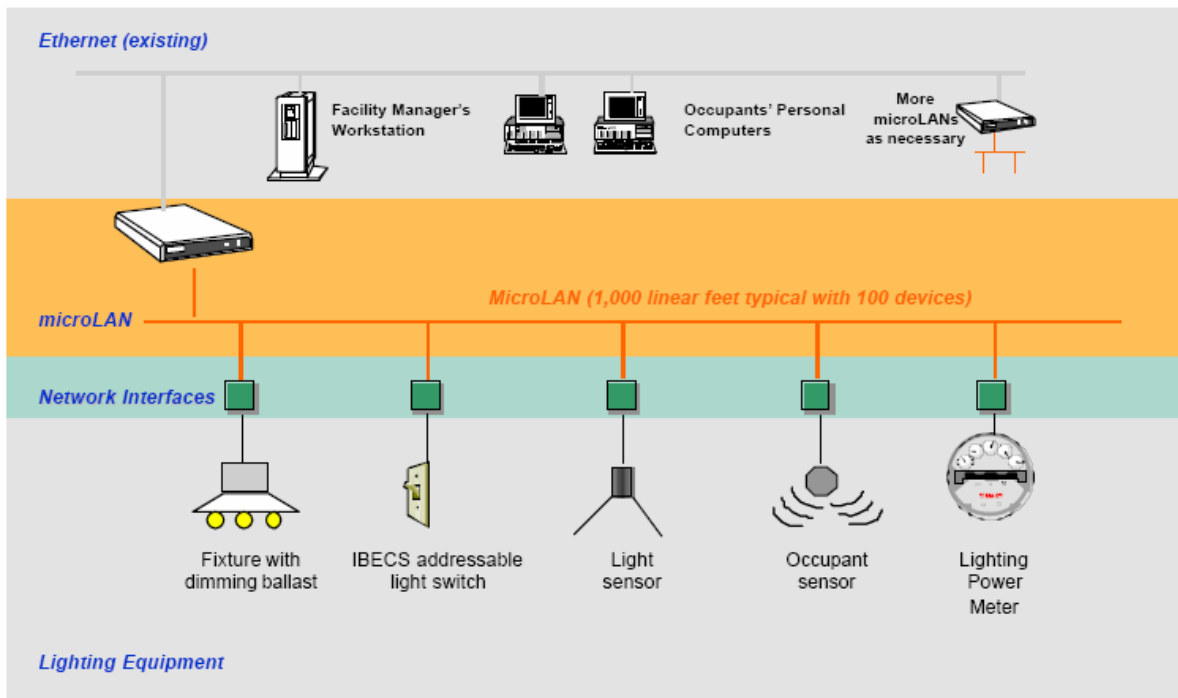

Figure 1. Diagram of IBECS Network.

One of the important features of the IBECS network is the integration of multiple networking technologies where various applications can run on workstations on existing

<sup>1</sup> Rubinstein, F. M., S. J. Johnson, et al. (2000). "IBECS: An Integrated Building Environmental Communications System—It's Not Your Father's Network". ACEEE Summer Study, Pacific Grove, CA

IT networks while the 1-wire network allows low cost sensor and actuator nodes to be built.

## Technical Specifications<sup>2</sup>

### Description of Technology

A 1-Wire net-based system consists of three main elements: a bus master with controlling software, the wiring and associated connectors and 1-Wire slave devices. The 1-Wire net allows tight control because no node is allowed to speak unless requested by the master, and no communication is allowed between slaves, except through the master. The 1-Wire network is defined with an open drain (wired-AND) master/slave multidrop architecture that uses a resistor pull-up to a nominal 5V supply at the master. The 1-Wire protocol uses conventional CMOS/TTL logic levels with operation specified over a supply voltage range of 2.8V to 6V. Both master and slaves are configured as transceivers permitting bit sequential data to flow in either direction, but only one direction at a time, with data read and written least significant bit (LSB) first.

Data on the 1-Wire net is transferred by time slots. For example, to write a logic one to a slave, the master pulls the bus low for 15µs or less. To write a logic zero, the master pulls the bus low for at least 60µs to provide timing margin for worst-case conditions. A system clock is not required, as each 1-Wire part is self-clocked by its own internal oscillator synchronized to the falling edge of the master.

Any microcontroller with at least a 1.8 MHz clock speed or a general purpose computer with a serial UART of at least 115.2 kbps can serve as a master for the 1-wire net.

Below is an illustration of a typical 1-wire communications sequence.

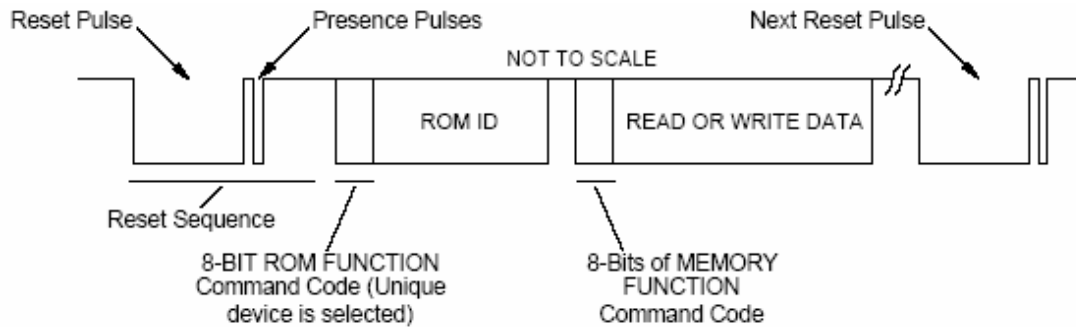

Figure 2. Typical 1-wire communications sequence.

When communicating, the master resets the network by holding the bus low for at least 480µs, releasing it, and then looking for a responding presence pulse from a slave connected to the line. If a presence pulse is detected, it then accesses the slave by calling its address, controlling the information transfer by generating time slots and examining

<sup>2</sup> Dallas Semiconductor, “Tech Brief 1 MicroLAN Design Guide”, and “Overview of 1-Wire Technology and Its Use”

the response from the slave. Once this handshake is successful, the master issues necessary device-specific commands and performs any needed data transfers between it and the slave. The master can select a single slave from many on the net because of its unique digital address.

Within each 1-Wire slave is stored a lasered ROM section with its own guaranteed unique, 64-bit serial number that acts as its node address. This globally unique address is composed of eight bytes divided into three main sections. Starting with the LSB, the first byte stores the 8-bit family codes that identify the device type. The next six bytes store a customizable 48-bit individual address. The last byte, the most significant byte (MSB), contains a cyclic redundancy check (CRC) with a value based on the data contained in the first seven bytes. This allows the master to determine if an address was read without error. With a  $2^{48}$  serial number pool, conflicting or duplicate node addresses on the net are never a problem.

Power for chip operation is derived from the bus during idle communication periods when the DATA line is at 5V by including a half-wave rectifier on each slave.

Whenever the data line is pulled high, the diode in the half-wave rectifier turns on and charges an on-chip capacitor. When the voltage on the net drops below the voltage on the capacitor, the diode is reverse biased, which isolates the charge. The resulting charge provides the energy source to power the slave during the intervals when the net is pulled low. The amount of charge lost during these periods is replenished when the data line returns high. This concept of “stealing” power from the net using a half-wave rectifier is referred to as “parasite power”.

Below is shown a typical 1-Wire device with both the line driver and parasite power circuit shown.

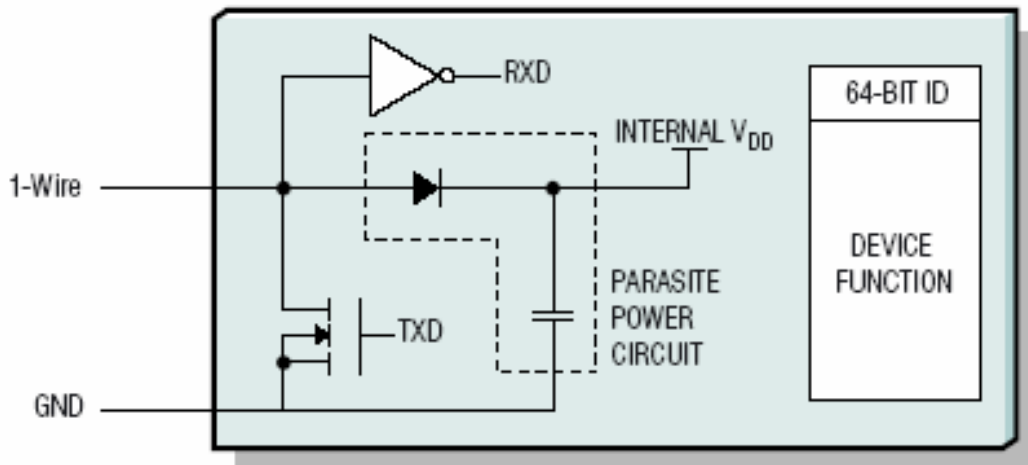

Figure 3. Typical 1-Wire device.

In practice more circuitry is added to further condition and drive the 1-Wire network to make it more reliable.<sup>3</sup>

### **Practical Considerations**

The 1-wire network has the benefit of being simple and very low cost to build into devices such as lighting controls where cost is of the utmost importance. Unfortunately, as it was originally conceived, there are a number of factors that limit its effectiveness when deployed as a network in real world applications.

In theory, a 1-wire network can operate with cable lengths over 100m, but in practice this requires a lot of extra engineering and consideration. There are numerous application notes on changing the timing and slew rate of the 1-wire signals and methods for actively driving the line in order to achieve these longer distances. There are also issues with the powering of devices on the 1-wire network which increases latency times and limits the number of devices that can realistically be used. In addition 1-wire can be adversely affected by EMI coming from other devices in its environment.

One method to overcome these shortcomings is to segment the 1-wire network by using the DS2409 MicroLAN coupler and use opto-couplers to eliminate some of the noise induced by any devices connected to the 1-wire network. This will help, but there will still be issues with communications between the DS2409 couplers.

To overcome these shortcomings LBNL has been funding research to develop a network that uses the 1-wire protocol over differential busses such as RS485. This “robust 1-wire” network was developed by Vistron<sup>4</sup> and goes under the codename of SlimNet. RS485 can communicate reliably over very long distances and is immune to many of the EMI that affect “standard” 1-wire. This new type of 1-wire network is achieved by building an RS485 backbone which has hubs on it that bridge the 1-wire and RS485 network segments. These hubs are truly bridges in that there is not timing or protocol translation, but just a conversion from the single ended domain of the 1-wire net to the differential RS485 signals. All the original 1-wire signal timing and encoding is preserved. This enables there to be very short 1-wire segments that allow existing 1-wire devices to communicate to each other over a reliable RS485 network. Although there is the extra added cost of adding the RS485 connection, these are typically inexpensive.

### **Available Devices**

One of the strengths of 1-wire is the diversity of off-the-shelf components that are available for designing and building 1-wire capable devices. Currently these components are primarily available from Maxim, the owner of the 1-wire technology. In addition to providing 1-wire IC's, Maxim also supplies pre-packaged modules called i-Buttons that are 1-wire capable devices packaged in a small 16mm stainless steel can.

---

<sup>3</sup> Dallas Semiconductor, Application Note 148, “Guidelines for Reliable 1-Wire Networks”

<sup>4</sup> Vistron. [pete@vistron.com](mailto:pete@vistron.com).



The following tables show a list of devices available from Maxim.

## 1-Wire® Devices

46 products

[List by Part Number](#)

Data Sheets	
<a href="#">QV</a> <a href="#">PDF</a>	DS28E04-100: 4096-Bit Addressable 1-Wire EEPROM with PIO
<a href="#">QV</a> <a href="#">PDF</a>	DS2482-100: Single-Channel 1-Wire Master
<a href="#">QV</a> <a href="#">PDF</a>	DS2482-800: Eight-Channel 1-Wire Master
<a href="#">QV</a> <a href="#">PDF</a>	DS2431: 1024-Bit 1-Wire EEPROM
<a href="#">QV</a> <a href="#">PDF</a>	DS9090K: 1-Wire Memory Evaluation Kit
<a href="#">QV</a> <a href="#">PDF</a>	DS2422: 1-Wire Temperature/Data Logger with 8kB Datalog Memory
<a href="#">QV</a> <a href="#">PDF</a>	DS9490: USB to 1-Wire/iButton Adapter
<a href="#">QV</a> <a href="#">PDF</a>	DS2408: 1-Wire 8-Channel Addressable Switch
<a href="#">QV</a> <a href="#">PDF</a>	DS1482: 1-Wire Level Shifter and Line Driver with Load Sensor
<a href="#">QV</a> <a href="#">PDF</a>	DS18S20: 1-Wire Parasite-Power Digital Thermometer
<a href="#">QV</a> <a href="#">PDF</a>	DS2502-E48: 48-Bit Node Address Chip
<a href="#">QV</a> <a href="#">PDF</a>	DS2411: Silicon Serial Number with V <sub>CC</sub> Input
<a href="#">QV</a> <a href="#">PDF</a>	DS2760: High Precision Li+ Battery Monitor
<a href="#">QV</a> <a href="#">PDF</a>	DS2433: 4kb 1-Wire EEPROM
<a href="#">QV</a> <a href="#">PDF</a>	DS1822: Econo 1-Wire Digital Thermometer
<a href="#">QV</a> <a href="#">PDF</a>	DS2401: Silicon Serial Number
<a href="#">QV</a> <a href="#">PDF</a>	DS2423: 4 kbit 1-Wire RAM with Counter
<a href="#">QV</a> <a href="#">PDF</a>	DS2430A: 256 bit 1-Wire EEPROM
<a href="#">QV</a> <a href="#">PDF</a>	DS18B20: High-Precision 1-Wire Digital Thermometer
<a href="#">QV</a> <a href="#">PDF</a>	DS2432: 1kb Protected 1-Wire EEPROM with SHA-1 Engine
<a href="#">QV</a> <a href="#">PDF</a>	DS2505: 16kb Add-Only Memory
<a href="#">QV</a> <a href="#">PDF</a>	DS1WM: Synthesizable 1-Wire Bus Master
<a href="#">QV</a> <a href="#">PDF</a>	DS2480: Serial 1-Wire Line Driver
<a href="#">QV</a> <a href="#">PDF</a>	DS2407: Dual Addressable Switch Plus 1 kbit Memory
<a href="#">QV</a> <a href="#">PDF</a>	DS2450: 1-Wire Quad A/D Converter
<a href="#">QV</a> <a href="#">PDF</a>	DS2404: EconoRAM Time Chip
<a href="#">QV</a> <a href="#">PDF</a>	DS9097U: Universal 1-Wire COM Port Adapter

<a href="#">QV</a>	<a href="#">PDF</a>	DS2506: 64kb Add-Only Memory
<a href="#">QV</a>	<a href="#">PDF</a>	DS2890: 1-Wire Digital Potentiometer
<a href="#">QV</a>	<a href="#">PDF</a>	DS2433-Z01: 4kb 1-Wire EEPROM
<a href="#">QV</a>	<a href="#">PDF</a>	DS2415: 1-Wire Time Chip
<a href="#">QV</a>	<a href="#">PDF</a>	DS2406: Dual Addressable Switch Plus 1kb Memory
<a href="#">QV</a>	<a href="#">PDF</a>	DS2405: Addressable Switch
<a href="#">QV</a>	<a href="#">PDF</a>	DS2502: 1kb Add-Only Memory
<a href="#">QV</a>	<a href="#">PDF</a>	DS9502: ESD Protection Diode
<a href="#">QV</a>	<a href="#">PDF</a>	DS9503: ESD Protection Diode with Resistors
<a href="#">QV</a>	<a href="#">PDF</a>	DS2409: MicroLAN Coupler
<a href="#">QV</a>	<a href="#">PDF</a>	DS2502-UNW, DS2505-UNW, DS2506-UNW: UniqueWare Add-Only Memory
<a href="#">QV</a>	<a href="#">PDF</a>	DS2502-E64: IEEE EUI-64 Node Address Chip
<a href="#">QV</a>	<a href="#">PDF</a>	DS9097, DS9097E: COM Port Adapter
<a href="#">QV</a>	<a href="#">PDF</a>	DS2404S-C01: Dual Port Memory Plus Time
<a href="#">QV</a>	<a href="#">PDF</a>	DS2480B: Serial 1-Wire Line Driver with Load Sensor
<a href="#">QV</a>	<a href="#">PDF</a>	DS2417: 1-Wire Time Chip With Interrupt
<a href="#">QV</a>	<a href="#">PDF</a>	DS2490: USB to 1-Wire Bridge Chip
<a href="#">QV</a>	<a href="#">PDF</a>	DS2223, DS2224: EconoRAM
<a href="#">QV</a>	<a href="#">PDF</a>	DS1481: 1-Wire Bus Master with Overdrive

**iButtons® and Accessories**  
57 products

[List by Part Number](#)

Data Sheets		
<a href="#">QV</a>	<a href="#">PDF</a>	DSECASH: eCash Evaluation Kit
<a href="#">QV</a>	<a href="#">PDF</a>	DS1402D-0XX: iButton Probe Component Parts
<a href="#">QV</a>	<a href="#">PDF</a>	DS1923: Hygrochron Temperature/Humidity Logger iButton with 8kB Data Log Memory
<a href="#">QV</a>	<a href="#">PDF</a>	DS1922L, DS1922T*: Temperature Logger iButton with 8kB Datalog Memory
<a href="#">QV</a>	<a href="#">PDF</a>	DS1977: Password-Protected 32kB EEPROM iButton
<a href="#">QV</a>	<a href="#">PDF</a>	DS1921G: ThermoChron iButton
<a href="#">QV</a>	<a href="#">PDF</a>	DS9093S, DS9093P: iButton Wall Mounts

<a href="#">QV</a> <a href="#">PDF</a>	DS9093RA, DS9093RB: iButton Plastic Card Mounts
<a href="#">QV</a> <a href="#">PDF</a>	DS9490: USB to 1-Wire/iButton Adapter
<a href="#">QV</a> <a href="#">PDF</a>	DS1994: 4kb Plus Time Memory iButton
<a href="#">QV</a> <a href="#">PDF</a>	DS1961S: 1kb Protected EEPROM iButton With SHA-1 Engine
<a href="#">QV</a> <a href="#">PDF</a>	DS1921H, DS1921Z: High Resolution Thermochron iButton Range H: +15°C to +46°C; Z: -5°C to +26°C
<a href="#">QV</a> <a href="#">PDF</a>	DS9096P: iButton Adhesive Pads
<a href="#">QV</a> <a href="#">PDF</a>	DS9098P: iButton Retainer
<a href="#">QV</a> <a href="#">PDF</a>	DS9097U: Universal 1-Wire COM Port Adapter
<a href="#">QV</a> <a href="#">PDF</a>	DS1921L-F5X: Thermochron iButton
<a href="#">QV</a> <a href="#">PDF</a>	DS9092L: iButton Probe with LED
<a href="#">QV</a> <a href="#">PDF</a>	DS1963S: SHA iButton
<a href="#">QV</a> <a href="#">PDF</a>	DS1973: 4 kbit EEPROM iButton
<a href="#">QV</a> <a href="#">PDF</a>	DS1904: RTC iButton
<a href="#">QV</a> <a href="#">PDF</a>	DS1982: 1 kbit Add-Only iButton
<a href="#">QV</a> <a href="#">PDF</a>	DS1986: 64 kbit Add-Only iButton
<a href="#">QV</a> <a href="#">PDF</a>	DS1982U, DS1985U, DS1986U: UniqueWare iButton
<a href="#">QV</a> <a href="#">PDF</a>	DS9092, DS9092GT, DS9092T: iButton Probe
<a href="#">QV</a> <a href="#">PDF</a>	DS9092R: iButton Port
<a href="#">QV</a> <a href="#">PDF</a>	DS9106: iButton Halo
<a href="#">QV</a> <a href="#">PDF</a>	DS9100: Touch and Hold Probe Stampings
<a href="#">QV</a> <a href="#">PDF</a>	DS9104: Digital Decoder Ring
<a href="#">QV</a> <a href="#">PDF</a>	DS9097, DS9097E: COM Port Adapter
<a href="#">QV</a> <a href="#">PDF</a>	DS9094: iButton Clip
<a href="#">QV</a> <a href="#">PDF</a>	DS9092K: iButton Starter Kit
<a href="#">QV</a> <a href="#">PDF</a>	DS9094SM: Surface-Mount iButton Clip
<a href="#">QV</a> <a href="#">PDF</a>	DS1996: 64 kbit Memory iButton
<a href="#">QV</a> <a href="#">PDF</a>	DS1963L: 4 kbit Monetary iButton
<a href="#">QV</a> <a href="#">PDF</a>	DS1985: 16 kbit Add-Only iButton
<a href="#">QV</a> <a href="#">PDF</a>	DS1991: MultiKey iButton
<a href="#">QV</a> <a href="#">PDF</a>	DS1971: 256 bit EEPROM iButton
<a href="#">QV</a> <a href="#">PDF</a>	DS1990A: Serial Number iButton
<a href="#">QV</a> <a href="#">PDF</a>	DS1920: Temperature iButton
<a href="#">QV</a> <a href="#">PDF</a>	DS1404: Touch and Hold Probe Cable Cradle

<a href="#">QV</a> <a href="#">PDF</a>	DS1995: 16 kbit Memory iButton
<a href="#">QV</a> <a href="#">PDF</a>	DS1413: Passive Serial Port iButton Holder
<a href="#">QV</a> <a href="#">PDF</a>	DS1921K: Thermochron iButton Starter Kit
<a href="#">QV</a> <a href="#">PDF</a>	DS1411: Serial Port iButton Holder
<a href="#">QV</a> <a href="#">PDF</a>	DS1992, DS1993: 1kb/4kb Memory iButton
<a href="#">QV</a> <a href="#">PDF</a>	DS1410K: iButton Developer's Kit
<a href="#">QV</a> <a href="#">PDF</a>	DS1420: Serial ID Button
<a href="#">QV</a> <a href="#">PDF</a>	DS1410D: Parallel Port Button Holder
<a href="#">QV</a> <a href="#">PDF</a>	DS1427: Time iButton
<a href="#">QV</a> <a href="#">PDF</a>	DS1425: Multi iButton
<a href="#">QV</a> <a href="#">PDF</a>	DS1422: 1 kbit Add-Only UniqueWare Button
<a href="#">QV</a> <a href="#">PDF</a>	DS1410E: Parallel Port Adapter
<a href="#">QV</a> <a href="#">PDF</a>	DS9101: Multipurpose Clip
<a href="#">QV</a> <a href="#">PDF</a>	DS9105: iButton Number Set
<a href="#">QV</a> <a href="#">PDF</a>	DS9093A, DS9093F, DS9093N: iButton Key Ring Mounts
<a href="#">QV</a> <a href="#">PDF</a>	DS1402X: 1-Wire Network Cables
<a href="#">QV</a> <a href="#">PDF</a>	DS1401: Front Panel iButton Holder

## Standards and Trade Organizations

1-Wire is not part of any standards group or trade organization. It is wholly owned and developed by Maxim (Dallas Semiconductor). In order to incorporate 1-Wire technology into products it is necessary to purchase IC's from Maxim.

## Companies

1-Wire is supported by a network of very devoted developers, hobbyists, and small companies. It is supported by hardware and software from a variety of companies that allow one to build very low cost and simple devices.

Below are examples of these companies:

### **316 Controls**

Provides a variety of control software that interfaces to TINI based controllers.

<http://www.316controls.com/>

### **AAG, Mexico**

Sells a range of 1-Wire modules. They also sell a very well made wind direction and speed sensor.

AAG has many good products: LCD display interface, counter modules, humidity, pressure, etc! Go to the "sensors and actuators" panel of their site.

For any 1-Wire work, you need an interface between the 1-Wire circuit and a supervising PC. AAG sell both the iButtonLink (a DS9097 replacement) and a USB interface. (\$40 and \$25 respectively.)

The TAI8586 (\$30) can count pulses on two channels. The inputs are put through opto-isolators to help reduce problems.

AAG has been selling 1-Wire equipment since 2001.

[AAG site.](#)

### **Elsist**

Elsist sells a variety of industrial controllers including the NETMASTER controller. The NETMASTER is a programmable controller based on a Dallas [TINI module](#). It is inserted in a standard DIN 43880 enclosure and by its connectivity in network allows an easy integration with other systems.

<http://www.elsist.net>

### **Hobby-Boards**

Eric Vickery is a new entrant to the 1-Wire hardware supply scene. He sells bare boards, kits, and (sometimes) assembled modules.

Below are some of his products. First is the part number, then description, then bare board price, then kit price, and then price for assembled module.

DC2-R1 Dual Counter \$3.00 \$26.00 [Guide to construction](#) from Sheepdog Software  
MMD1-R1 Mini Motion Detector \$3.00 \$25.00 [Guide to construction](#) from Sheepdog Software  
HT2-R1 Humidity / Temperature \$4.50 \$47.00  
BB4-R2 Bray Barometer \$10.00 \$57.00  
LD3-R1 Lightning Detector \$7.00 \$29.50  
SR2-R1 Solar Radiation \$3.00 \$19.50  
4R1-R1 Relay \$14.50 \$43.00  
LCD1-R1 LCD Driver \$7.50 \$29.00 / \$45.50  
HVAC1-R1 HVAC Monitor \$6.50 \$26.00  
MM1-R1 Moisture Meter \$5.00 \$22.00  
LWS1-R1 Leaf Wetness Sensor \$3.00  
GSS1-R2 Gypsum Soil Sensor \$3.00

[Eric's site, Hobby-Boards](#)

**Springbok Digitronics**

Sells a number of useful modules. The humidity module (It can be adapted for monitoring a variety of things.... it has an ADC chip. It also has a temperature sensor, and some EEPROM) and the module for receiving an iButton. It also has a temperature sensor.

A feature of the modules is that the main chips are "downstream" from a DS2409 coupler chip (as used in hubs) so, by manipulating (through software) the switches in the coupler, you can hide things from the MicroLan. Also, all of the boards incorporate a DS2433 (512 bytes) EEPROM on the Aux line.

[Springbok Digitronics](#)

**ITWatchDogs**

This is a commercial site. They have a device called the Weather Duck, \$199. It was designed to monitor server rooms, but could be put to many uses. It monitors numerous things including: Temperature, humidity, airflow, 4 general purpose inputs, and light level. They also have a number of other units. They also have some other interesting things...

WeatherGoose: Contains internal Web server, rack mount option, \$389  
Remote air-flow/temperature sensor, \$50  
Devices for monitoring electrical current: 30, 60, or 120 amp current transducers.  
Power Egg - monitors volts, amps, watts, and accumulated KWh.

[ITWatchDogs](#)

**Simon Atkins**

Simon is primarily a source of information about using 1-Wire, but he does have a few pcbs for the "Version 3" barometer, bare boards only.

[Simon Atkins](#)

**iButtonLink**

iButtonLink's flagship product is a DB-9 serial port to 1-Wire interface, which some feel to be superior to the DS9097 Dallas sells. It is a replacement for the DS9097, but has more features. The iButtonLink sells for \$39.

They also have a device called the LinkTH. You plug it into a serial port, and plug a sensor into it, and the computer can now read temperatures and humidities from the LinkTH with a simple ASCII communication. The LinkTH, minus sensor, was \$39 at May 2004. Many temperature/ humidity sensors can be added to a single LinkTH.

[iButtonLink](#)

**Systronix**

This company is one of the main supporters of the Dallas "TINI": The TINI is small embedded computer that looks somewhat like a memory SIMM, but consists of a computer, Ethernet interface, java machine, 1-Wire interface, etc.

[Systronix](#)

**TowerTech**

TowerTech makes a variety of 1-Wire interfaces for hand held devices such as Palm PDA's.

<http://www.towertech.it/>

**Embedded Data Systems**

Embedded Data Systems has a broad offering. They offer the Ha7e (Cost \$39) which is a box that plugs into your PC's serial port and to a MicroLan. You control and read from it with simple ASCII commands.

[Embedded Data System's site](#)

# MODBUS

## Introduction and Background

MODBUS® Protocol is a messaging structure developed by Modicon in 1979, used to establish master-slave/client-server communication between intelligent devices. It is one of the oldest and most widely deployed protocols used in industrial automation, used by 1000's of companies in millions of nodes worldwide.

## Technical Specifications<sup>5</sup>

MODBUS is an application layer messaging protocol, positioned at level 7 of the OSI model, which provides client/server communication between devices connected on different types of buses or networks. It is currently implemented using:

- TCP/IP over Ethernet.
- Asynchronous serial transmission over a variety of media (wire: EIA/TIA-232-E, EIA-422, EIA/TIA-485-A; fiber, radio, etc.)
- MODBUS PLUS, a high speed token passing network.

The MODBUS communications stack is depicted below.

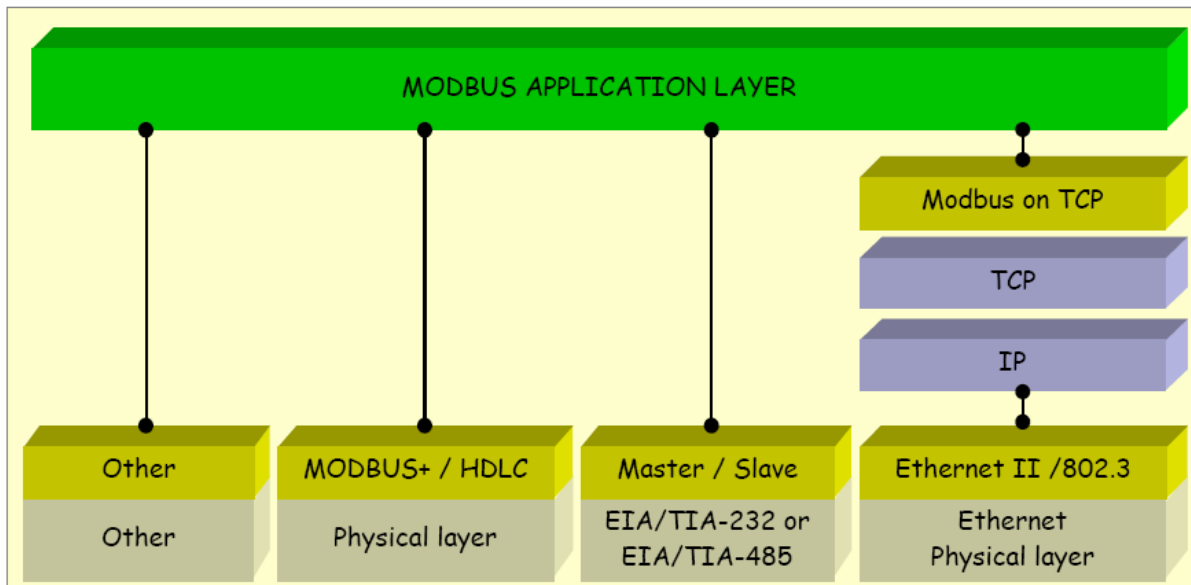

Figure 4. MODBUS communications stack.

<sup>5</sup> MODBUS APPLICATION PROTOCOL SPECIFICATION V1.1a



The diagram below depicts a network of devices using the various incarnations of MODBUS.

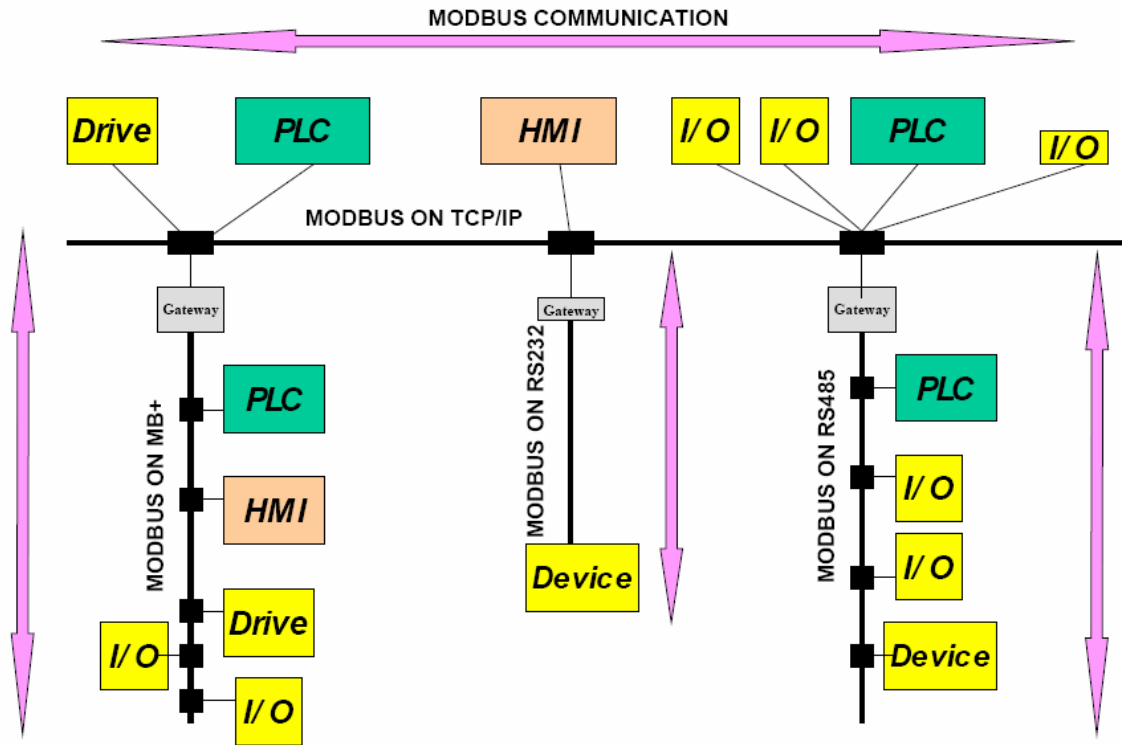

Figure 5. Device network using MODBUS.

The same communication can be done as well on serial line as on an Ethernet TCP/IP networks. Gateways allow communications between several types of buses or network using the MODBUS protocol.

**General Protocol Description**

As depicted below, the MODBUS protocol defines a simple protocol data unit (PDU) independent of the underlying communication layers. The mapping of MODBUS protocol on specific buses or network can introduce some additional fields on the application data unit (ADU).

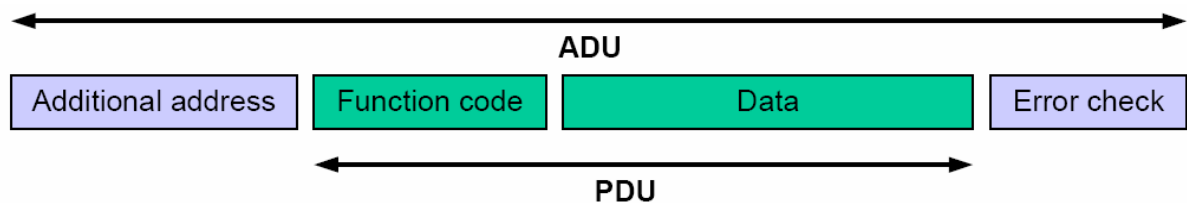

Figure 6. Protocol data unit defined by MODBUS.

The ADU is built by the client that initiates a MODBUS transaction. The function code indicates to the server what kind of action to perform. The function code field of a

MODBUS data unit is coded in one byte. Valid codes are in the range of 1 ... 255 decimal (128 – 255 reserved for exception responses). When a message is sent from a Client to a Server device the function code field tells the server what kind of action to perform. Sub-function codes are added to some function codes to define multiple actions. The data field of messages sent from a client to server devices contains additional information that the server uses to take the action defined by the function code. This can include items like discrete and register addresses, the quantity of items to be handled, and the count of actual data bytes in the field. The data field may be nonexistent (of zero length) in certain kinds of requests, in this case the server does not require any additional information. The function code alone specifies the action.

If no error occurs related to the MODBUS function requested in a properly received MODBUS ADU the data field of a response from a server to a client contains the data requested. If an error related to the MODBUS function requested occurs, the field contains an exception code that the server application can use to determine the next action to be taken. For example a client can read the ON / OFF states of a group of discrete outputs or inputs or it can read/write the data contents of a group of registers. When the server responds to the client, it uses the function code field to indicate either a normal (error-free) response or that some kind of error occurred (called an exception response). For a normal response, the server simply echoes to the request the original function code. For an exception response, the server returns a code that is equivalent to the original function code from the request PDU with its most significant bit set to logic 1.

The following diagram depicts an error free transaction between the client and server.

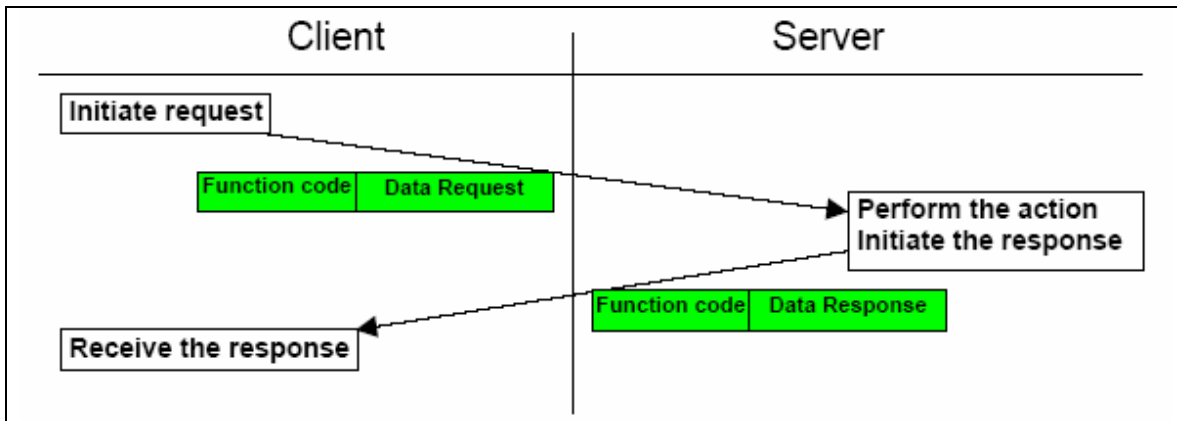

Figure 7. Error-free transaction between client and server.

The following diagram depicts a transaction with errors between the client and server.

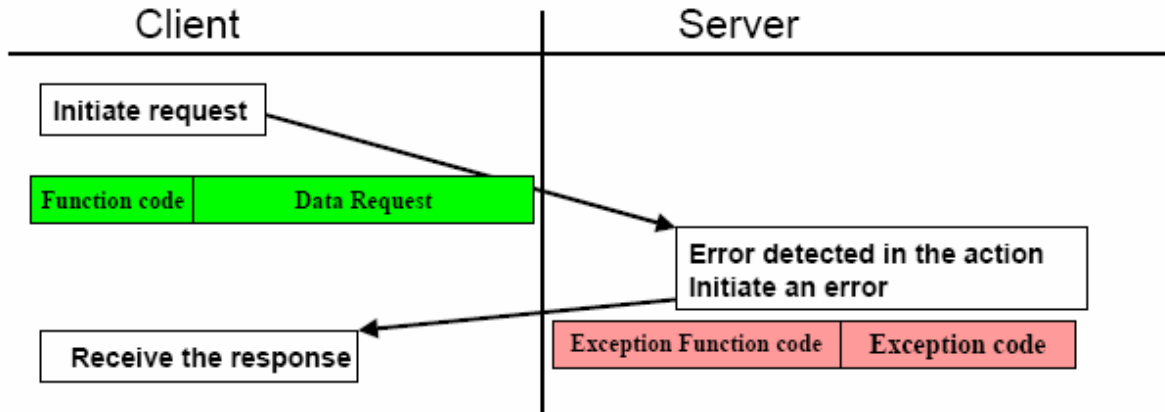

Figure 8. Transaction with errors.

The MODBUS functions codes are organized as follows:

*Public Function Codes*

- Are well defined function codes
- guaranteed to be unique,
- validated by the modbus.org community,
- publicly documented
- have available conformance test,
- are documented in the MB IETF RFC,
- includes both defined public assigned function codes as well as unassigned function codes reserved for future use.

The table below shows the public function codes with a reference to the section in the “MODBUS APPLICATION PROTOCOL SPECIFICATION V1.1a” where it is described in more detail.

				Function Codes			
				<i>code</i>	<i>Sub code</i>	<i>(hex)</i>	<i>Section</i>
<b>Data Access</b>	<b>Bit access</b>	Physical Discrete Inputs	Read Discrete Inputs	<b>02</b>		<b>02</b>	6.2
		Internal Bits Or Physical coils	Read Coils	<b>01</b>		<b>01</b>	6.1
			Write Single Coil	<b>05</b>		<b>05</b>	6.5
	Write Multiple Coils		<b>15</b>		<b>0F</b>	6.11	
	<b>16 bits access</b>	Physical Input Registers	Read Input Register	<b>04</b>		<b>04</b>	6.4
		Internal Registers Or Physical Output Registers	Read Holding Registers	<b>03</b>		<b>03</b>	6.3
			Write Single Register	<b>06</b>		<b>06</b>	6.6
			Write Multiple Registers	<b>16</b>		<b>10</b>	6.12
			Read/Write Multiple Registers	<b>23</b>		<b>17</b>	6.17
			Mask Write Register	<b>22</b>		<b>16</b>	6.16
		Read FIFO queue	<b>24</b>		<b>18</b>	6.18	
	<b>File record access</b>	Read File record		<b>20</b>	<b>6</b>	<b>14</b>	6.14
		Write File record		<b>21</b>	<b>6</b>	<b>15</b>	6.15
	<b>Diagnostics</b>	Read Exception status		<b>07</b>		<b>07</b>	6.7
		Diagnostic		<b>08</b>	<b>00-18,20</b>	<b>08</b>	6.8
Get Com event counter		<b>11</b>		<b>0B</b>	6.9		
Get Com Event Log		<b>12</b>		<b>0C</b>	6.10		
Report Slave ID		<b>17</b>		<b>11</b>	6.13		
Read device Identification		<b>43</b>	<b>14</b>	<b>2B</b>	6.21		
<b>Other</b>		Encapsulated Interface Transport	<b>43</b>	<b>13,14</b>	<b>2B</b>	6.19	

*User-Defined Function Codes*

- there is a defined two ranges of user-defined function codes, i.e. 65 to 72 and from 100 to 110 decimal.
- user can select and implement a function code without any approval from modbus.org
- there is no guarantee that the use of the selected function code will be unique
- if the user wants to re-position the functionality as a public function code, he must
- initiate an RFC to introduce the change into the public category and to have a new public function code assigned.

*Reserved Function Codes*

- Function Codes currently used by some company for legacy products and that are not available for public use.

### **Serial Implementation<sup>6</sup>**

The MODBUS protocol is commonly implemented on either point to point RS232 connections or multi-drop RS485 connections. In either case no particular baud rate is required and can be set to whatever is required. There are recommended cabling specifications for the various modes of communication.

Two different serial transmission modes are defined: The RTU mode and the ASCII mode. It defines the bit contents of message fields transmitted serially on the line. It determines how information is packed into the message fields and decoded. Although the ASCII mode is required in some specific applications, interoperability between MODBUS devices can be reached only if each device has the same transmission mode: All devices must implement the RTU Mode. The ASCII transmission mode is an option.

When devices communicate on a MODBUS serial line using the RTU (Remote Terminal Unit) mode, each 8-bit byte in a message contains two 4-bit hexadecimal characters. The main advantage of this mode is that its greater character density allows better data throughput than ASCII mode for the same baud rate.

When devices are setup to communicate on a MODBUS serial line using ASCII mode, each 8-bit byte in a message is sent as two ASCII characters. This mode is used when the physical communication link or the capabilities of the device does not allow the conformance with RTU mode requirements regarding timers management. ASCII mode is less efficient than RTU since each byte needs two characters.

### **MODBUS OVER TCP/IP<sup>7</sup>**

A communicating system over MODBUS TCP/IP may include different types of device:

- A MODBUS TCP/IP Client and Server devices connected to a TCP/IP network
- The Interconnection devices like bridge, router or gateway for interconnection between the TCP/IP network and a serial line sub-network which permit connections of MODBUS Serial line Client and Server end devices.

These devices are depicted in the diagram below.

---

<sup>6</sup> MODBUS over Serial Line Specification & Implementation guide V1.0

<sup>7</sup> MODBUS MESSAGING ON TCP/IP IMPLEMENTATION GUIDE V1.0a

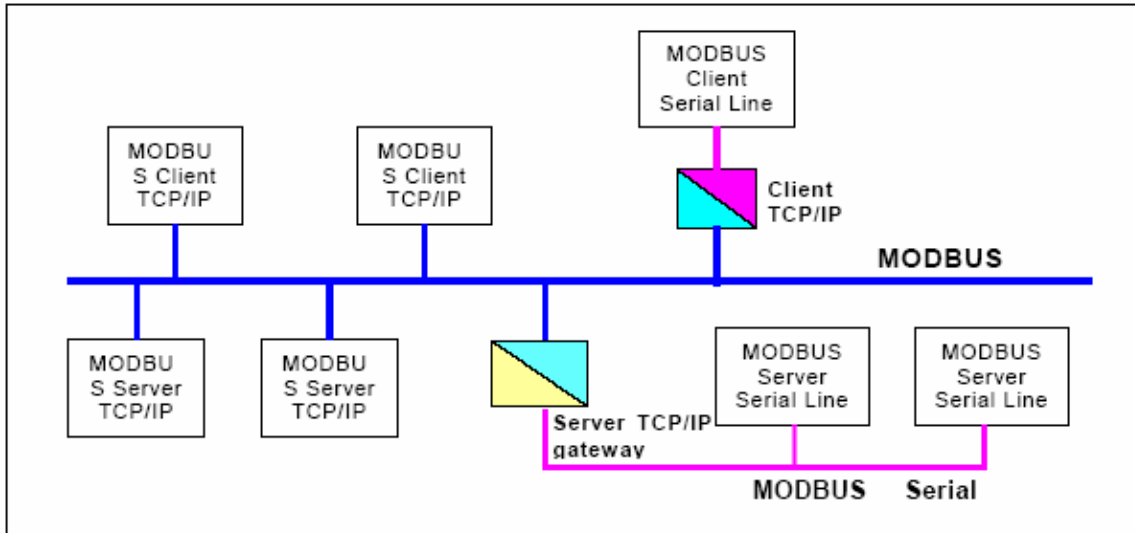

Figure 9. Range of devices on MODBUS network.

As shown below a dedicated header is used on TCP/IP to identify the MODBUS Application Data Unit. It is called the MBAP header (MODBUS Application Protocol header).

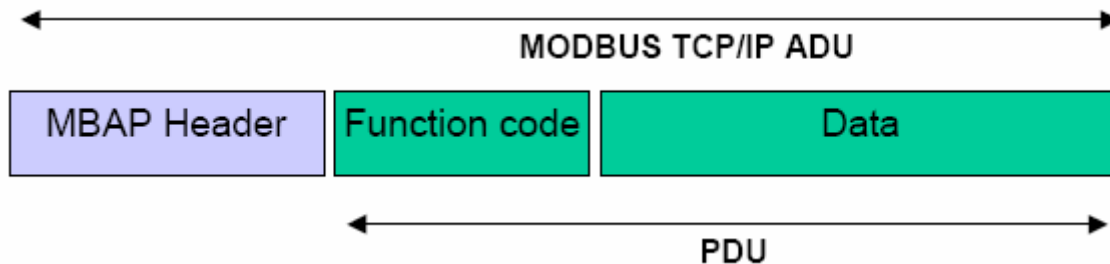

Figure 10. The MBAP Header.

This header provides some differences compared to the MODBUS RTU application data unit used on serial line:

- The MODBUS ‘slave address’ field usually used on MODBUS Serial Line is replaced by a single byte ‘Unit Identifier’ within the MBAP Header. The ‘Unit Identifier’ is used to communicate via devices such as bridges, routers and gateways that use a single IP address to support multiple independent MODBUS end units.
- All MODBUS requests and responses are designed in such a way that the recipient can verify that a message is finished. For function codes where the MODBUS PDU has a fixed length, the function code alone is sufficient. For function codes carrying a variable amount of data in the request or response, the data field includes a byte count.
- When MODBUS is carried over TCP, additional length information is carried in the MBAP header to allow the recipient to recognize message boundaries even if the message has been split into multiple packets for transmission. The existence

of explicit and implicit length rules, and use of a CRC-32 error check code (on Ethernet) results in an infinitesimal chance of undetected corruption to a request or response message.

Port 502 has been reserved for MODBUS over TCP/IP.

## Standards and Trade Organizations

In May of 2004 ownership of Modbus was transferred from Schneider Electric to the non-profit organization Modbus-IDA. Their web site can be found at <http://www.modbus.org/default.htm> where you can also find the following mission statement:

“Modbus-IDA is a group of independent users and suppliers of automation devices that seeks to drive the adoption of the Modbus communication protocol suite and the evolution to address architectures for distributed automation systems across multiple market segments. Modbus-IDA will also provide the infrastructure to obtain and share information about the protocols, their application and certification to simplify implementation by users resulting in reduced costs.”

Schneider Automation has submitted the Modbus TCP/IP protocol specification to the **Internet Engineering Task Force (IETF)**

## Companies

There are literally hundreds if not thousands of companies that have used MODBUS in their products and systems. Some of the more significant companies, as taken from the Modus-IDA web site, can be found in Appendix B. A sampling of companies that provide enabling technologies for implementing MODBUS devices include:

- MESCO - [www.mesco.de](http://www.mesco.de)
- ProSoft Technology, Inc. - [www.prosoft-technology.com](http://www.prosoft-technology.com)
- RTI - [www.rti.com](http://www.rti.com)
- WinTECH - <http://www.win-tech.com/html/devtools.htm>

# ZigBee

## Introduction and Background

ZigBee is the name of a trade organization currently comprising more than 100 companies. ZigBee was formerly known as PURLnet, RF-Lite, Firefly, and HomeRF Lite and represents the consolidation of these various trade groups dating back to the mid-90's. The goal of ZigBee is to develop a low cost, low data rate, and low power RF protocol for a wide range of applications including:

- Building Automation
  - security
  - HVAC
  - AMR
  - lighting control
  - access control
- Personal Health Care
  - patient monitoring
  - fitness monitoring
- Industrial Control
  - asset mgt
  - process control
  - environmental
  - energy mgt
- Consumer Electronics
  - TV
  - VCR
  - DVD/CD
  - Remote
- PC & Peripherals
  - mouse
  - keyboard
  - joystick
- Residential/Light Commercial Control
  - security
  - HVAC
  - lighting control
  - access control
  - lawn & garden irrigation



Sometimes ZigBee and the IEEE 802.15.4 standard are used interchangeably, but in reality IEEE 803.15.4 is an official standard that covers the lower RF physical and MAC layers of the protocol while ZigBee is a specification that is concerned with the protocol layers above the MAC level. The ZigBee specification references the 802.15.4 standard. This is analogous to the relationship between WiFi (an industry trademark and certification) and 802.11.

Despite the fact that the specification has only recently been finalized, many companies already claim to have ZigBee ready components and it is expected that ZigBee compliant products will begin to appear in 2005.

### Technical Specifications

For the sake of discussion the technical specification can be divided into the following three areas<sup>8</sup>:

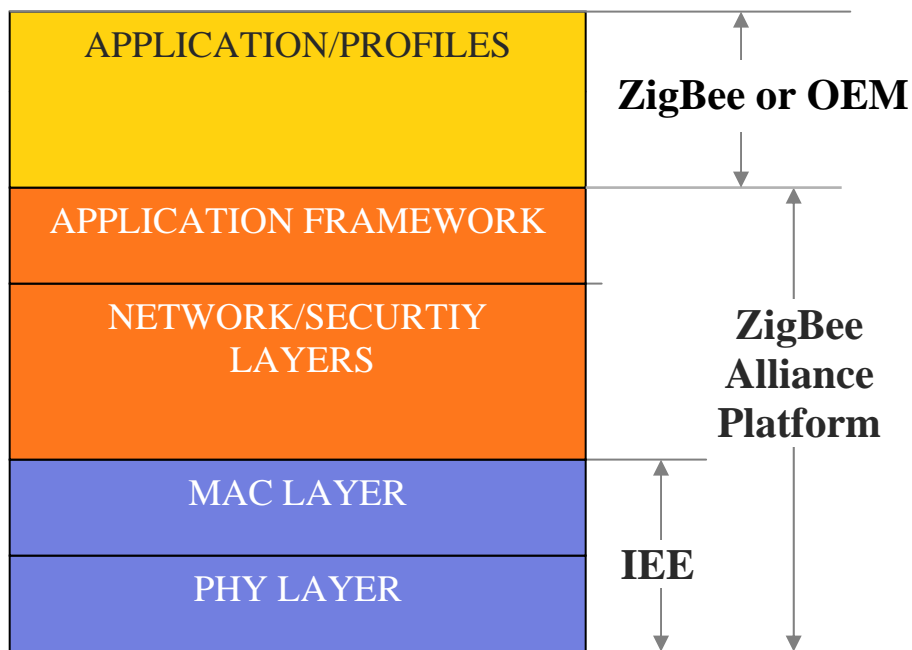

- Application**
- ZigBee Platform Stack**
- Silicon**

The following sections cover these areas in more detail.

---

<sup>8</sup> *Emerging Standards: Where does ZigBee fit, October, 2004, Bob Heile, Chairman, ZigBee Alliance*

The table below gives a useful comparison between various RF standards in use today.

<b>Feature(s)</b>	<b>IEEE 802.11b</b>	<b>Bluetooth</b>	<b>ZigBee</b>
Power Profile	Hours	Days	Years
Complexity	Very Complex	Complex	Simple
Nodes/Master	32	7	64000
Latency	Enumeration up to 3 seconds	Enumeration up to 10 seconds	Enumeration 30ms
Range	100 m	10m	70m-300m
Extendibility	Roaming possible	No	YES
Data Rate	11Mbps	1Mbps	250Kbps
Security	Authentication Service Set ID (SSID)	64 bit, 128 bit	128 bit AES and Application Layer user defined

#### IEEE 802.15.4

The general characteristic of 802.15.4 are the following:

- Data rates of 250 kb/s, 40 kb/s and 20 kb/s.
- Star or Peer-to-Peer operation.
- Support for low latency devices.
- CSMA-CA channel access.
- Dynamic device addressing.
- Fully handshaked protocol for transfer reliability.
- Low power consumption.
- Frequency Bands of Operation
  - 16 channels in the 2.4GHz ISM band
  - 10 channels in the 915MHz ISM band
  - 1 channel in the European 868MHz band.

IEEE 802.15.4 is part of the IEEE 802 suite of protocols and has the following general architecture.<sup>9</sup>

---

<sup>9</sup> IEEE 802.15.4 Tutorial, 4 January, 2003, Jose Gutierrez, Eaton Corporation

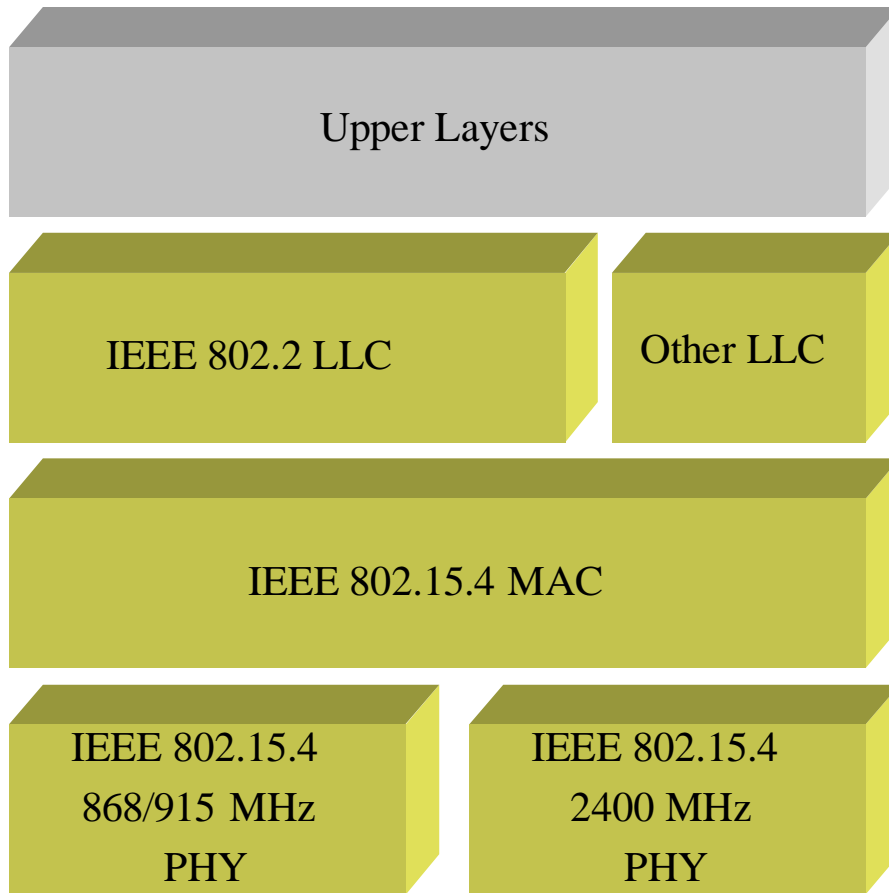

Figure 11. IEEE 802.15.4 architecture.

#### 1.1.1.1. 802.15.4 PHY

The characteristics of the physical layer are the following:

Transmit Power

- Capable of at least 1 mW

Transmit Center Frequency Tolerance

- $\pm 40$  ppm

Receiver Sensitivity (Packet Error Rate <1%)

- -85 dBm @ 2.4 GHz band
- -92 dBm @ 868/915 MHz band

RSSI Measurements

- Packet strength indication
- Clear channel assessment
- Dynamic channel selection

The physical layer is designed to operate at a number of different frequencies with the following modulation characteristics:

## 2.4 GHz PHY

- 250 kb/s (4 bits/symbol, 62.5 kBaud)
- Data modulation is 16-ary orthogonal modulation
- 16 symbols are ~orthogonal set of 32-chip PN codes
- Chip modulation is MSK at 2.0 Mchips/s

## 868MHz/915MHz PHY

- Symbol Rate
  - 868 MHz Band: 20 kb/s (1 bit/symbol, 20 kBaud)
  - 915 MHz Band: 40 kb/s (1 bit/symbol, 40 kBaud)
- Data modulation is BPSK with differential encoding
- Spreading code is a 15-chip m-sequence
- Chip modulation is BPSK at
  - 868 MHz Band: 300 kchips/s
  - 915 MHz Band: 600 kchips/s

As shown below each frequency band also has a number of available channels that can be used.

### 802.15.4 PHY Operating Frequency Bands

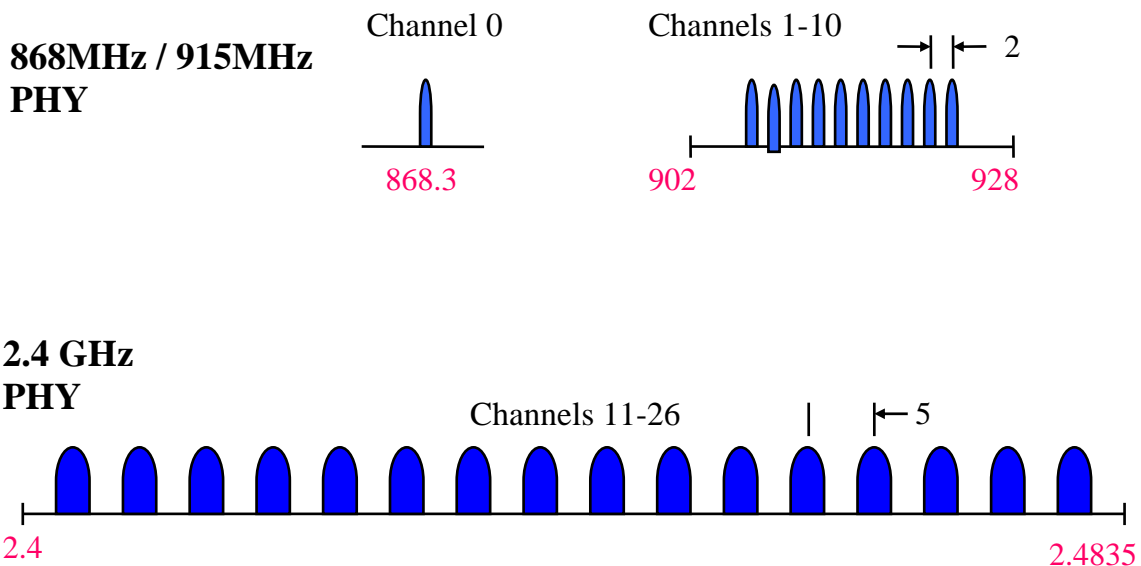

Figure 12. Operating frequency bands.

The physical layer has the packet structure shown below.

## 802.15.4 PHY Packet Structure

### PHY Packet Fields

Preamble (32 bits) – synchronization

Start of Packet Delimiter (8 bits)

PHY Header (8 bits) – PSDU length

PSDU (0 to 1016 bits) – Data field

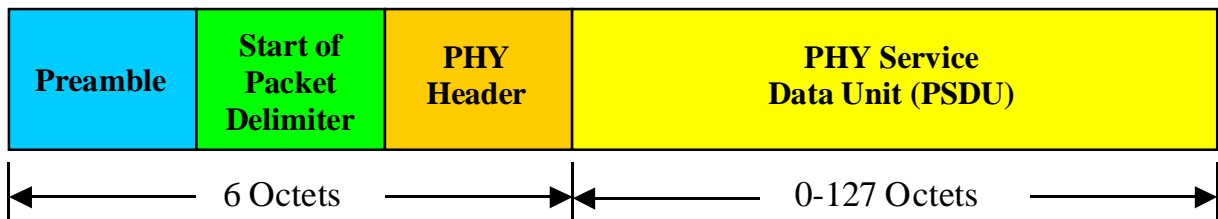

Figure 13.

### 1.1.1.2. 802.15.4 MAC

The MAC layer is designed to handle a variety of topologies including both star and peer to peer. In addition the MAC is designed to support the following two different types of devices:

- Full function device (FFD)
  - Any topology
  - Network coordinator capable
  - Talks to any other device
  
- Reduced function device (RFD)
  - Limited to star topology
  - Cannot become a network coordinator
  - Talks only to a network coordinator
  - Very simple implementation

RFD's are intended for very simple devices such as light switches whereas FFD can perform communications routing and forwarding functions. An example topology that uses both is shown below:

### 802.15.4 Combined Topology

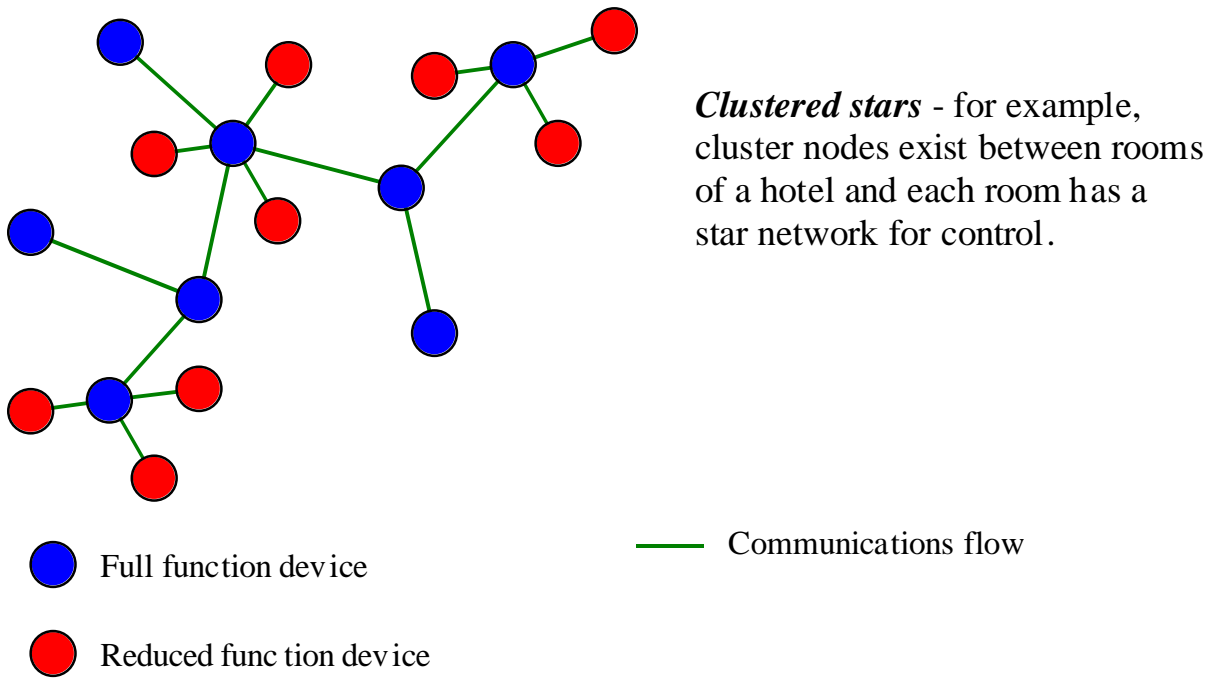

Figure 14.

Finally the structure for the MAC layer protocol is shown below.

## 802.15.4 MAC General Frame Structure

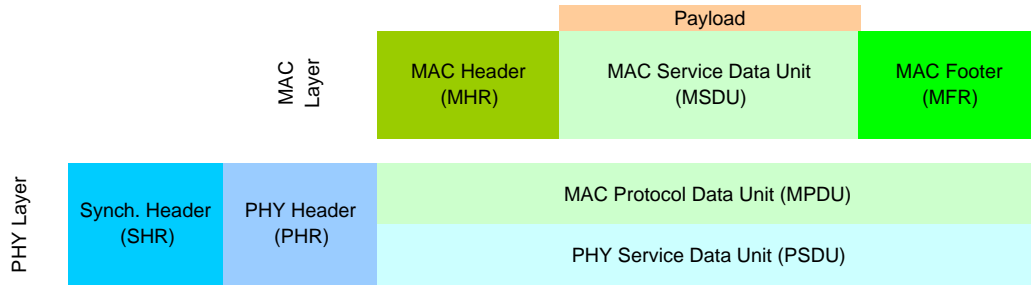

Figure 15.

### ZigBee Protocol

The ZigBee protocol is built on top of the 802.15.4 MAC layer. It provides routing and application level interfaces and is optimized for timing-critical applications. The ZigBee protocol has the following characteristics:

- 65,536 network (client) nodes
- Network join time: 30 ms (typ)
- Sleeping slave changing to active: 15 ms (typ)
- Active slave channel access time: 15 ms (typ)

The ZigBee protocol supports both star and mesh networks and as the diagram below shows there are different types of nodes defined.

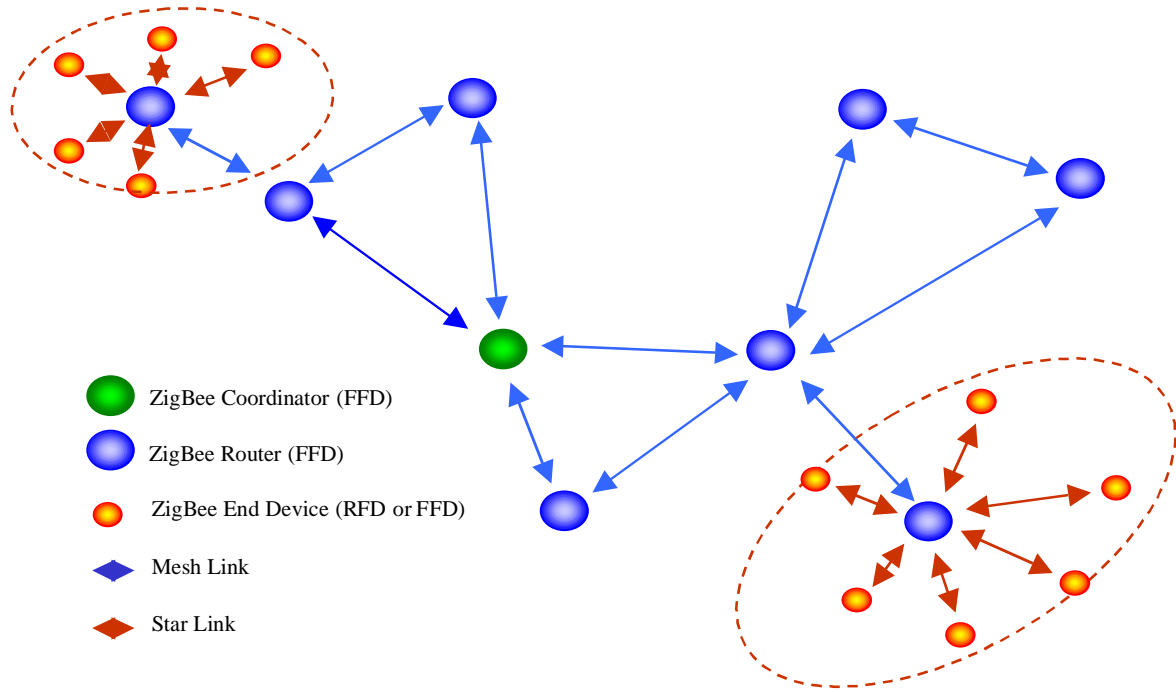

Figure 16. Types of nodes in the ZigBee network.

## ZigBee Application Profiles

ZigBee is developing a number of application level profiles that will enable vendors within a specific market segment to interoperate. The Lighting Control profile will be released first. Examples of the type of profiles being developed include the following.

### *Lighting Control*

#### Advance Transformer

- Wireless lighting control
  - Dimmable ballasts
  - Light switches anywhere
  - Customizable lighting schemes
  - Energy savings on bright days
  - Dali [or other] interface to BMS
- Extendable networks
  - Additional sensors



- Other networks

### *HVAC Energy Management*

#### Hotel energy management

- Major operating expense for hotel
  - Centralized HVAC management allow hotel operator to make sure empty rooms are not cooled
- Retrofit capabilities
- Battery operated t-stats can be placed for convenience
- Personalized room settings at check-in

### *Asset Management*

- Within each container, sensors form a mesh network.
- Multiple containers in a ship form a mesh to report sensor data
- Increased security through on-truck and on-ship tamper detection
- Faster container processing. Manifest data and sensor data are known before ship docks at port.

## **Standards and Trade Organizations**

### **ZigBee**

The ZigBee specification was finalized and ratified in December of 2004. The specification will not be made public and will only be available to members of the ZigBee organization.

The ZigBee trade organization has had a significant increase in membership the last 2 – 3 years and continues to grow rapidly. It represents companies from many countries and spans all regions of the world. Its official web site can be found at [www.ZigBee.org](http://www.ZigBee.org).

The diagram below shows ZigBee's current organization chart.

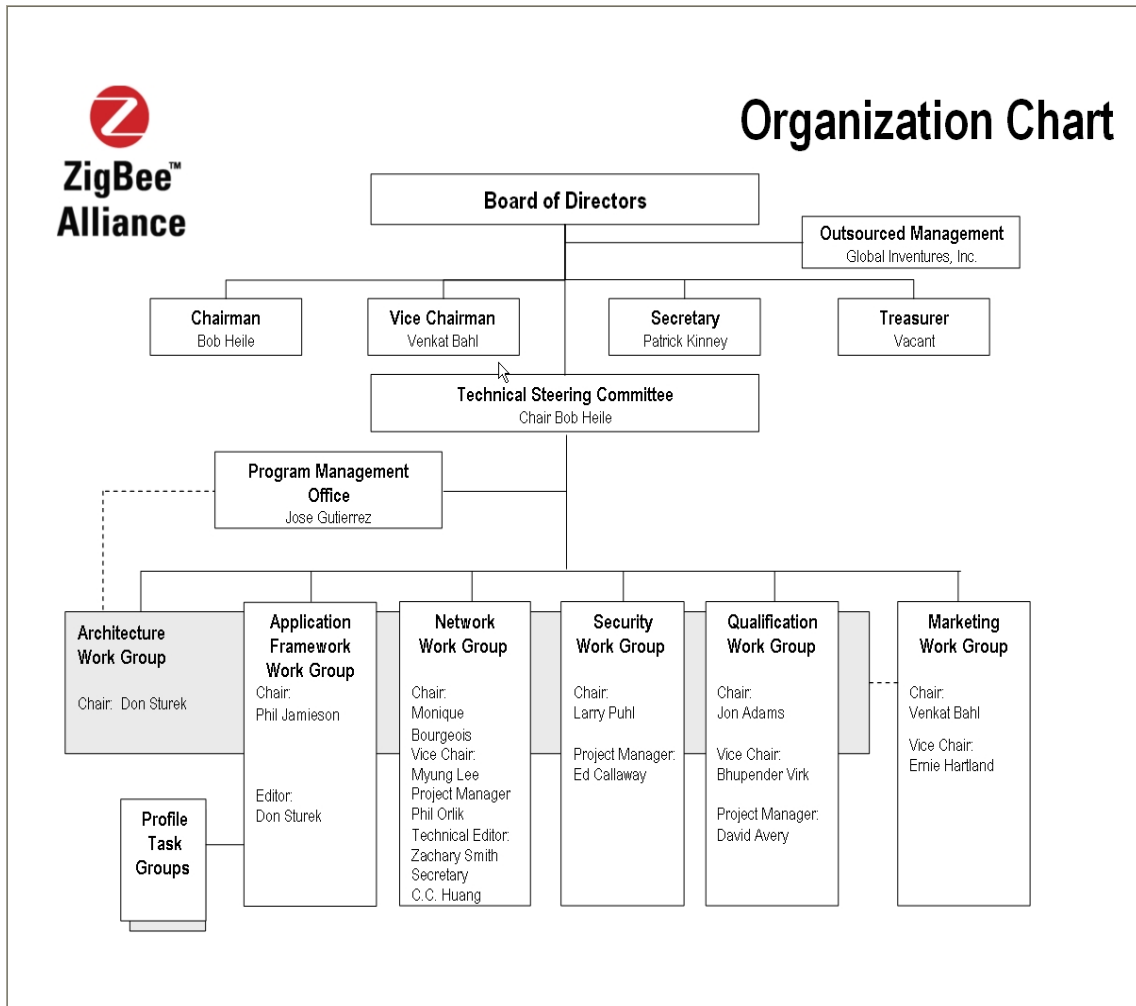

Figure 17. ZigBee organization chart.

### IEEE 802.15.4

The IEEE 802.15.4 standard that ZigBee relies upon was approved in May of 2003 and is maintained by the IEEE Standard Association. Their web site can be found at <http://www.ieee802.org/15/pub/TG4.html>.

### IEEE 1451.5

IEEE 1451 will play an important role in many of the devices and applications that use the ZigBee protocol. IEEE 1451 is a suite of standards each aimed at standardizing a different aspect of communications for smart transducers. More specifically 1451.5 is concerned with RF communications and in particular ZigBee. While 1451.5 is not a part of the ZigBee specification, ZigBee is part of the 1451.5 standard. IEEE 1451.5 and ZigBee are complimentary standards. Where ZigBee is concerned with the communications protocol IEEE 1451 is concerned with how data elements within devices are modeled and documented.

IEEE 1451 is governed by the IEEE Standards Association and their website can be found at <http://grouper.ieee.org/groups/1451/5/>.

## Companies

To date a vast number of companies support ZigBee in a variety of ways providing everything from hardware and software components to design, testing and manufacturing services for ZigBee products. Some of the more significant companies providing enabling core hardware and software components include:

- CompXS
- Ember
- Freescale
- Motorola
- Philips
- AMI Semiconductor
- Chipcon
- Crossbow
- Figure 8 Wireless, Inc.
- Helicomm
- Microchip
- MaxStream
- OKI
- Silicon Wave
- ZMD

Currently it is possible to buy transceivers and protocol software that allow the ZigBee protocol to be embedded into products for a cost of approximately \$15 in quantity. It is estimated that sometime during 2005 this price will drop below \$10 and decrease yearly as more competition arises.

Examples of companies offering development environments for ZigBee are shown below.





Company's Name	Product Description	Ouch!!!
 Helicomm	ZigBee DevKit 1000 – “an out of box” Zigbee Network. Sensors & line power for operational testing provided.	A\$6.105.00
 Crossbow TECHNOLOGY INC.	MOTE-KIT2400 – for deeply embedded sensor networks. More freedom design but starts from scratch.	A\$4.885.00
 Chipcon	CC2420DK – highly integrated and very flexible low cost solution. Evaluates RF performance of the CC2420.	A\$994.00
 freescalse semiconductors	13192DSK-A00 – starter’s kit providing all hardware (re-usable), software and sensors. Peer-to-peer and star networks only.	A\$310.00

Figure 19. Companies offering development environments for ZigBee.

A more complete listing of companies involved in the ZigBee effort can be found in Appendix B.

# DALI

## Introduction and Background

DALI is an acronym for **D**igital **A**ddressable **L**ighting **I**nterface. As the name implies it is mainly targeted toward lighting applications. It is based upon the technical standard IEC 60929.

Research work connected to the DALI project began midway through the 1990s. However, the development of commercial applications got underway in the summer of 1998. At that time, DALI went under the name DBI (Digital Ballast Interface). An interface device (or ballast) is an electronic inductor enabling control of fluorescent lamps. In addition to the work done at Helvar, the DALI standard has been the subject of R&D by other European ballast manufacturers such as Hüco, Philips, Osram, Tridonic, Trilux and Vossloh-Schwabe.

Using DALI, different manufacturers' products can be interconnected and interoperate. The DALI standard embodies addressability, i.e. ballasts can be controlled individually when necessary. To date, ballasts connected to an analogue 1-10 VDC low-voltage control bus have been subject to simultaneous control.

Another advantage enabled by the DALI standard is communicating the status of ballasts back to the control unit. This is especially useful in extensive installations where the light fixtures are widely distributed. The execution of commands compliant with the DALI standard and obtaining the status data presuppose intelligence on part of the ballast. This is provided by mounting a microprocessor within the ballast.

## Technical Specifications

### General Characteristics

DALI is a step on from the DSI protocol, which is used by HF fluorescent ballasts. One of the main advantages that DALI has over earlier systems is that each device on a segment of data cable can be separately addressed, as DSI and 1-10V devices are not separately addressable and can only be controlled as a group. The net result is that to achieve similar control functionally, DALI requires less complex (and therefore less expensive) wiring topology than DSI or 1-10V devices. The table below contrasts DALI with existing lighting control standards.

Control Type	Control Cable	Control Signal	Polarity Dependant	0% while Energized	Individually Addressable
DALI	2 wire	Manchester Encoded	No	Yes	Yes
DSI	2 wire	Manchester Encoded	No	Yes	No

1-10V	2 wire	1-10 Volt DC Analogue	Yes	No	No
-------	--------	-----------------------------	-----	----	----

DALI devices include fluorescent HF ballasts, low voltage transformers, PE cells, motion detectors, wall switches and gateways to other protocols. There can be up to 64 DALI devices on a single DALI network. Sites requiring more than 64 devices are implemented by having multiple separate DALI networks, each with up to 64 devices. These separate networks are then linked together with DALI gateways and a data backbone running a high level protocol, such as Dynalite’s DyNet.

The following is a list of the general characteristics of the DALI network according to IEC 60929<sup>10</sup>.

- Maximum number of devices                    64
- Number of Groups                                 16
- Number of Scenes per Group                 16
- Data Cable                                         2 wires
- Data Encoding Method                         Manchester
- Data Baud Rate                                 2400 baud
- Network Power Supply                         24V DC 250mA

If control units using the DALI protocol are to be used in a system then the system size will be limited to either 64 nodes or 250mA total system current (whichever value is reached first). When a DALI system is to be constructed containing both ballasts and control units it should be ensured that these limits are not exceeded. If the system size exceeds the limitations there will be problems due to reduced signal integrity. Some devices may fail to communicate or respond to commands and the system operation will become unstable. In addition the maximum voltage drop on the DALI line may not exceed 2V, resulting in a maximum line length of 300 m, between the DALI components furthest apart. Below is a diagram of a typical DALI installation. It should be noted that NEMA is currently developing a DALI protocol<sup>11</sup> based upon the IEC standard that supports two different cabling classes that allow for longer cable runs.

---

<sup>10</sup> IEC 60929-2003, Edition 2.0, A.C. Supplied Electronic Ballasts for Tubular Fluorescent Lamps— Performance Requirements, Annex E, “Control Interface for Controllable Ballasts”

<sup>11</sup> NEMA Standard Publication 243-2004, *Digital Addressable Lighting Interface (DALI) Control Devices Protocol*, Part 1-2004, General Requirements

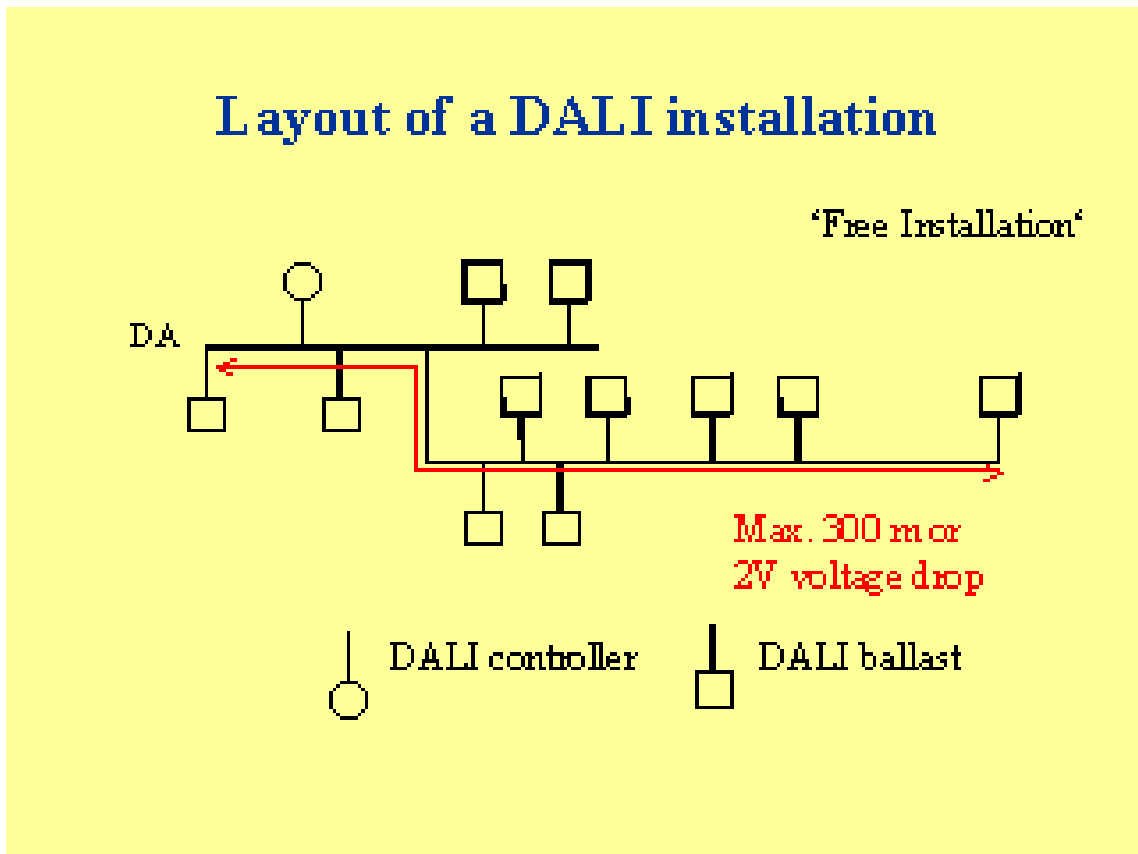

Figure 20. Layout of DALI installation.

### DALI Communications Description

The two-wire DALI data bus is referred to as a “loop.” A loop connects up to 64 lighting devices (i.e., ballasts, transformers, relays, and others). The data bus is powered by at least one Loop Power Supply. Messages are sent by momentarily shorting and releasing the loop conductors to create a digital signal. Below is a schematic of a loop that contains both ballasts and a dimming control.

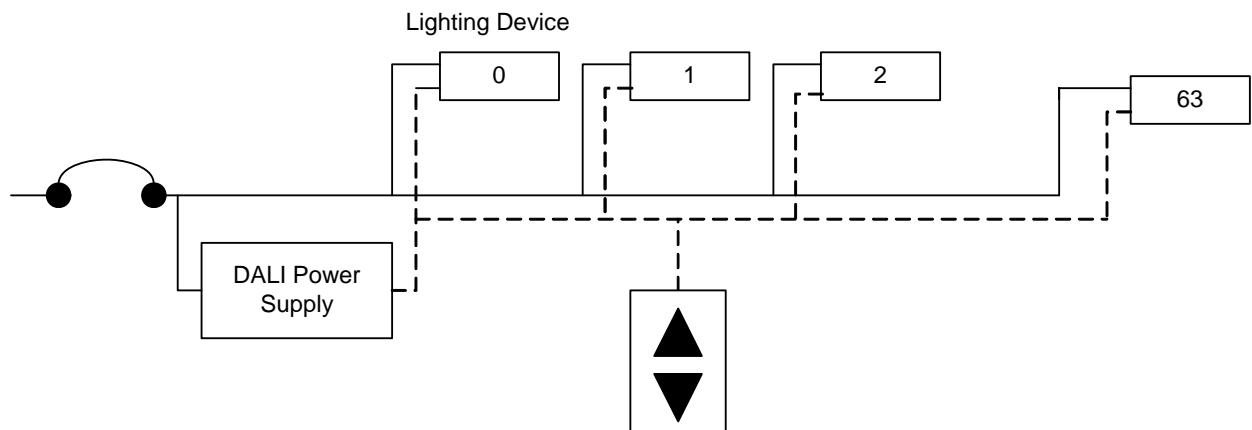

Figure 21. DALI communications loop.

Furthermore other control devices could be added to the above configuration, as shown below. To control specific ballasts or groups of ballasts, however, the control module must be logically linked to those ballasts. This may be done by assigning the targeted ballasts to groups and then having the control module configured to talk to that specific group. Doing so requires a programming tool.

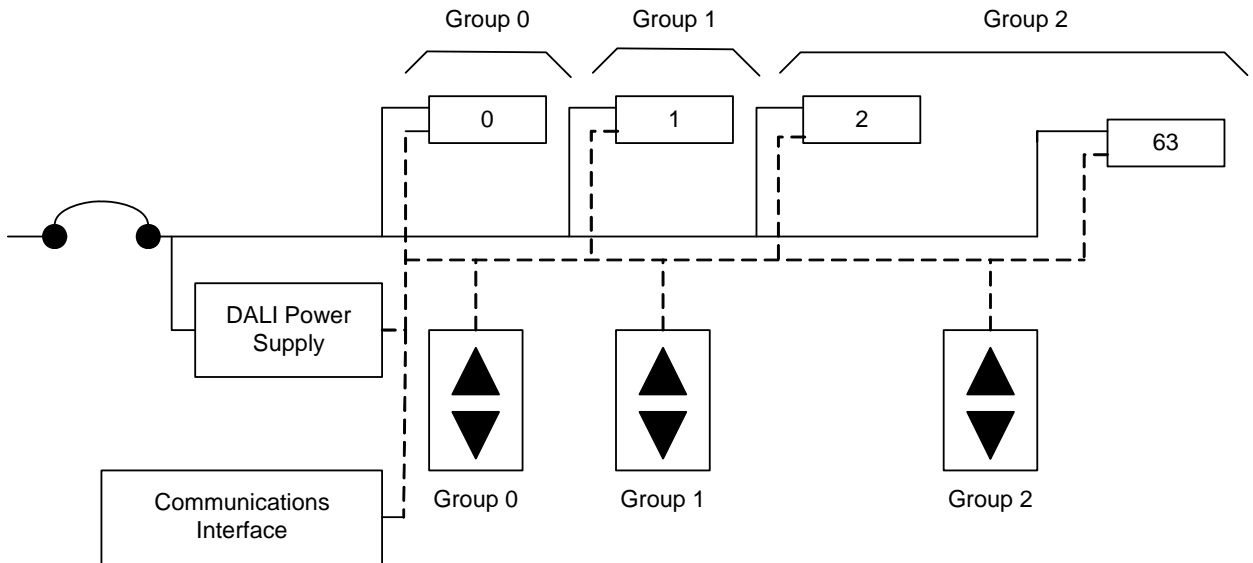

Figure 22. Communications loop with additional control devices.

DALI messages comply with the Bi-Phase, or Manchester, coding in which the bit values "1" and "0" are presented as two different voltage levels so that the change-over from the logic level "UNTRUE" to "TRUE" corresponds to bit value "1", and the change-over from the logic level "TRUE" to "UNTRUE" corresponds to the bit value "0". The coding includes error detection and enables power supply to the control units also when there are no messages being transmitted or when the same bit value is repeated several times in succession. The bus's forward frame (from the control unit to the ballast) is comprised of 1 START bit, 8 address bits, 8 data/command bits, and 2 STOP bits. The backward frame (from the ballast to the control unit) is comprised of 1 START bit, 8 data bits and 2 STOP bits. Below are shown example forward and backward frames.



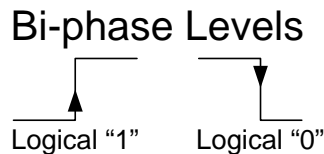
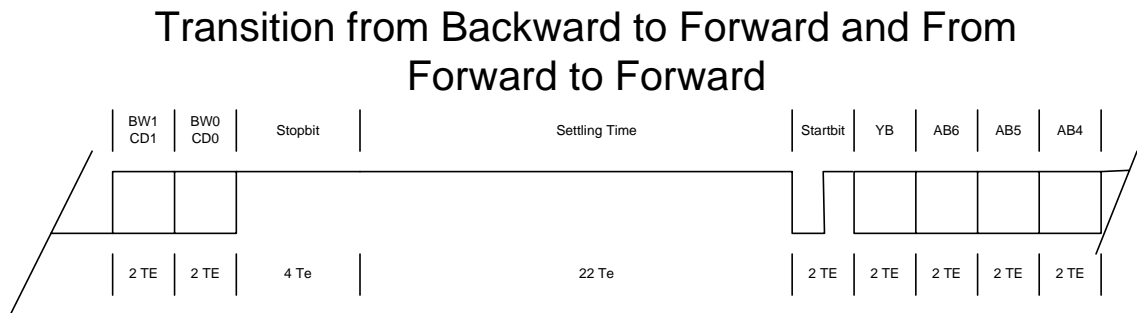
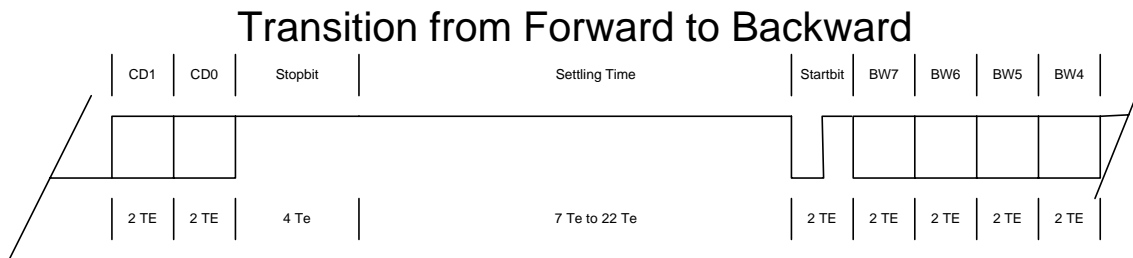
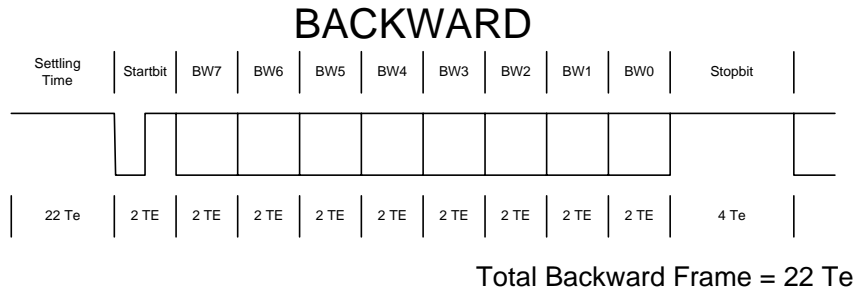
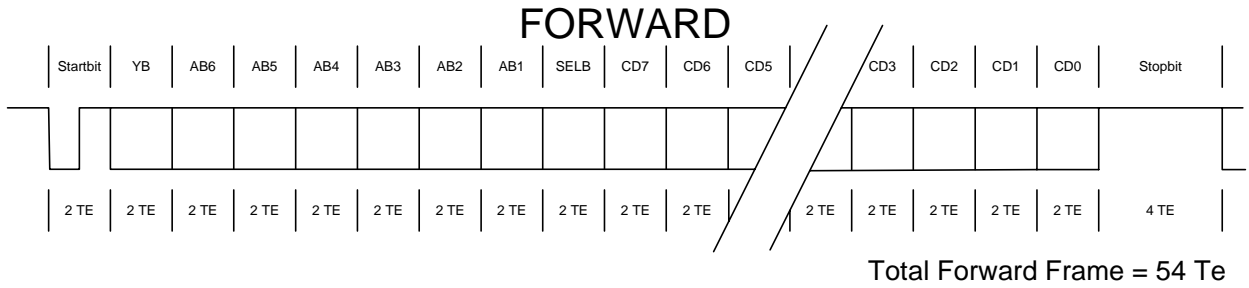

Figure 23. Forward and backward frames on control bus.

DALI messages consist of an address part and a command part. The address part determines which DALI module the message is intended for. All the modules execute

commands with "broadcast" addresses. Sixty-four unique addresses are available plus sixteen group addresses. A particular module can belong to more than one group at the one time. The following are the type of addresses supported by each DALI device.

- DALI Broadcast Command - All ballasts connected to a loop shall respond to a command sent at the Broadcast Command Level. All ballasts on a DALI loop shall respond at the same time and in the same way to a broadcast command. No commissioning is required for a ballast to respond to a broadcast command.
- DALI Group Command - Ballast may belong to one or several of 16 groups (0-15). Commissioning is required to place in the ballast memory those groups to which the ballast will respond. To be able to assign groups to the ballasts, the units need to be addressed. Commands to ballasts on a DALI loop may be sent to a specific group of ballasts by sending a Group Command. All ballasts belonging to this group shall respond at the same time and in the same way to this command. Note—Group Commands are often used to control specific areas of a room, e.g., front wall washers, or to control multiple rooms on a DALI loop where each room is assigned a different group.
- DALI Individual Address Command - Ballasts may be assigned a unique individual address. There are 64 possible addresses (0-63). No two ballasts shall have the same address on a DALI loop. Commissioning is required to place in the ballast an Individual Address Command. Sending an Individual Address Command shall send commands on a DALI loop to specific ballasts. The ballast with this address shall respond to the Individual Address Command.

Typical DALI commands are the following:

- Go to light level xx.
- Go to minimum level
- Set value xx as regulation speed
- Go to level compliant with situation xx
- Turn lamp off
- Query: What light level are you on?
- Query: What is your status?

## **Standards and Trade Organizations**

AG-DALI (<http://www.dali-ag.org/>) is a trade organization dedicated to promoting and developing the use of DALI. AG-DALI was founded to promote the DALI standard and to penetrate the digital lighting solutions possible with DALI products. It is a non-profit organization and the activities are paid by the membership fees of its members.

The DALI protocol is documented within the IEC 60929 and currently the draft is in the IEC confirmation resp. approval procedure.

In addition DALI is in the process of being standardized by NEMA and will be published under NEMA Standards Publication 243-2004.

## Companies

Numerous companies support DALI through research and the development of products that use it. A sampling of many such companies are given below and a more complete listing is given in Appendix C.

- **Eensors Inc.** - [http://www.eensors.com/ES05\\_announce.html](http://www.eensors.com/ES05_announce.html)
- **International Rectifier** - <http://www.irf.com/>
- **Philips Lighting B.V.** - <http://www.philips.com>

## Synopsis and Comparisons

The following is a table that gives a synopsis of various characteristics of the network technologies covered in this report.

	1-Wire Net	DALI	MODBUS (serial)	MODBUS (Ethernet)	ZigBee
Network Speed	9600 baud 115 Kbaud, if overdrive is used.	2400 baud	No specific speed specified. Can be up to whatever RS232 or RS485 can handle, i.e. 1Mbps	10Base2: 10Mbps 10BaseT: 10Mbps 100BaseT: 100Mbps	20 kbps - , 40 kbps, 250 kbps depending upon frequency
Error Control	8 and 16 bit CRC's	none	CRC	Ethernet CRC	CRC
Latency	Depends upon the operation. Ranges from very low to very high.	Moderate to high	Very low	Very low	Low to moderate (Typically 30 ms)
Communications Distance	100's of meters with appropriate signal conditioning.	300m or 2V drop	Depends upon physical serial channel. Can be 1000's m for RS485	10Base2 – 185m 10BaseT – 100 m 100BaseT – 100m	70m – 300m
Topology	Serial multi-drop half-duplex bus	Serial bus	Point to point or multi-drop	Multi-drop and star with hubs	Ad Hoc wireless network
Cable Polarization	Yes, single ended	no	RS232 – yes RS485 - no	Yes	NA
Industry Adoption and Deployment	modest	Very good	Extremely high	Very High	Just beginning, but has very high support and interest.
Security	none	none	none	none	128 AES
Standards	None	IEC 60929-2003, NEMA 243-2004	Modbus-IDA	Modbus-IDA	IEEE 802.15.4, ZigBee trade organization

The following general comments can be made about each technology.

- In terms of the Bill of Material (BOM) cost the most inexpensive technology is 1-wire although it has not been accepted by the industry as much as other technologies and requires further development in order to reduce its installation costs and viability for commercial applications.
- MODBUS is the most mature and well accepted technology, but it also suffers from higher installation costs (due to wiring) than DALI and ZigBee. Although it has wide adoption it is most commonly used in industrial control applications as opposed to building automation.
- DALI is rapidly gaining acceptance and is cost effective for lighting control applications. The installation costs are low due to the fact that it communicates over the same wires that the nodes derive power from. On the down side the protocol is very specific to lighting control and is not appropriate for other types of telemetry and control applications.
- ZigBee is relatively new, but has generated a lot of interest within the control industry. It is backed by both a strong industry consortium and an IEEE standard. Because there is no wiring required for ZigBee it promises to have the lowest installation costs. Furthermore many applications can only be solved with wireless devices and thus of the technologies reviewed ZigBee is the only one that will satisfy those requirements. On the downside RF communications are not as reliable as wired communications and this may render ZigBee inappropriate for many applications.
- None of the technologies reviewed adequately address the issue of commissioning devices in the field. Different approaches are used to deploy and commission devices and it is highly dependent upon the application. More work needs to be done in this area since installing and commissioning devices are typically a much larger expense than the devices themselves.

## Acknowledgments

This work was supported by the Assistant Secretary for Energy Efficiency and Renewable Energy, Building Technologies Program, of the U.S. Department of Energy under Contract No. DE-AC03-76SF00098.

## Appendices – Company profiles

### Appendix A - MODBUS Technology Companies

#### ACKSYS

ACKSYS designs and manufactures entirely in Europe a comprehensive range of communication solutions for all those sectors of the industry for which performance, reliability and sustainability constitute a main objective (e.g., industrial automation, telecom, aeronautics, army, transport and medical fields) including serial multiport boards, intelligent serial synchronous controllers, serial-to-Ethernet device servers, serial-to-wireless device servers and interface converters.

Website: [www.acksys.fr](http://www.acksys.fr)

#### Control

Control Corporation is a worldwide leader of device connectivity for industrial applications. In 1982, Control pioneered device integration by inventing, HOSTESS®, the industry's first multi-port serial controller card for personal computers. The company then released RocketPort® - the first multi-port serial controller offering high performance at a low cost. Control now provides serial device control technology with its DeviceMaster® device servers that provide Ethernet-attached serial ports. Devicemaster is programmable so that it can run applications that enable it to eliminate the need for standard PCs on the factory floor. Control's technology is involved in many postal automation systems, baggage handling systems, power utility automation, automotive assembly facilities, as well as other machine control and data acquisition applications. Control manages communications for PLC or PC platforms, between plant floor devices and information management systems. Control's platforms support protocols for serial devices including RFID readers, weight indicators, bar code scanner and label printer/applicators. Control partners with peripheral manufacturers, OEMs, software developers, industrial distributors and other industrially focused organizations to provide systems integrators and OEMs the right tools for data communications and device connectivity.

Website: [www.control.com](http://www.control.com)

#### connectBlue

connectBlue is a leading supplier of complete Bluetooth solutions for industrial and commercial use, offering products, engineering services, and training. Our experts come from both the telecom- and automation industries. They have the deep technical knowledge required for developing wireless solutions in industrial applications and products. The specialists have extensive experience from industrial applications and Bluetooth implementations within software and hardware development.

Website: [www.connectBlue.se](http://www.connectBlue.se)

### **Control Technology Corporation**

Control Technology Corporation designs, manufactures and markets products that enable electronic automation devices to be monitored, controlled, configured or reprogrammed at the machine level and through network connections. CTC's automation controllers and software are used in a wide range of industrial and commercial applications, including Web-based control, motion control, analog and digital I/O control and remote data acquisition. CTC's software and hardware products are divided into three application areas that can be implemented independently or combined for a complete shop-floor to top-floor integrated solution.

Website: [www.ctc-control.com](http://www.ctc-control.com)

### **D&D Automation**

D&D Automation teams with machine builders, integrators and end users providing digital and analog solutions that meet and exceed productivity objectives. We provide expertise in all areas of automation engineering from systems design and documentation through fabrication, programming, start-up services and training. We design and implement systems ranging from islands of control, such as single machines and processes, to fully integrated, plant-wide automated and networked information systems. Our knowledge of industry standard hardware and software allows D&D Automation to provide integrated solutions that meet the exacting needs of our clients and the markets they serve. Through strategic systems integration, we can help you achieve your business goals faster and more cost-effectively than ever before.

Website: [www.ddauto.com](http://www.ddauto.com)

### **Entivity**

Entivity, headquartered in Ann Arbor, Michigan, was formed in 2001 as the result of a merger between two leaders in PC-based manufacturing controls, Think & Do Software and Steeplechase Software. The newly formed company quickly established itself as a leading provider of PC-based manufacturing automation and control software. Entivity offers advanced software products that improve productivity in the development, deployment, and operation of automated material handling, machine control, and manufacturing systems. These products use intuitive, open architectures that integrate easily with almost any hardware and software components. Entivity products aim to increase manufacturers' return on investment (ROI) in technology and processes by using widely adopted, easy-to-use networking and database tools from Microsoft to link plant floor processes with production management systems. Entivity's software product groups are:

- PC-control software
- Embedded control software
- Human-machine interface (HMI) software
- Productivity analysis software

With more than 5,000 customers and tens of thousands of software installations worldwide, Entivity technology benefits manufacturing enterprises in many different industries. Entivity is a highly successful innovator in its field and owns five patents. In addition, it has 19 patents pending and 10 patents in process.

Website: [www.entivity.com](http://www.entivity.com)

### **eWon**

Belgian company ACTL sa manufactures the eWON, a PIR - Programmable Industrial Router. The device provides Gateway, RAS modem and eSCADA capabilities to allow unique powerful applications for remote service and maintenance by PLC over the Internet or MODBUS device using standard device configuration software. The eWON's data acquisition, datalogging, alarms, reporting, and other features allow integrators and machine builders to add value to their products by offering powerful and complete remote servicing tools.

Website: [www.ewon.biz](http://www.ewon.biz)

### **FieldServer Technologies**

FieldServer Technologies' gateways and protocol translators interface building automation systems, fire alarm panels, process controls and other devices and networks to Modbus network and systems. FieldServer also has over 75 different drivers interfacing to over 350 different devices. When an integrator needs to interface LonWorks, BACnet, Metasys, DH+, Ethernet/IP, Profibus or a wide range of other protocols to a Modbus system, FieldServer has a solution. In addition to stand-alone gateways, FieldServer also has ProtoCessor, an embedded Protocol Coprocessor, for device design engineers to use to provide proven Modbus output (serial or TCP) from their devices. Check out our website for further information on the various gateways and driver protocols.

Website: [www.fieldserver.com](http://www.fieldserver.com)

### **HARTING Electric**

HARTING Electric develops, manufactures and sells industrial connectors, connector technology and system components to clients active in the fields of mechanical engineering, automation technology, transportation and power engineering. High manufacturing automation levels ensure outstanding product quality. At HARTING Electric, production operations are based on high precision injection molding equipment, fully automated high precision contact manufacturing, high precision die-casting, fully automated powder plating as well as state of the art cable production facilities in connection with advanced testing equipment.

Website: [www.harting.com](http://www.harting.com)

### **HMS Industrial Networks AB**

HMS Industrial Networks AB was founded in 1988. From its headquarters in Sweden, HMS has expanded its operations with offices and support centers in the United States, Japan, Germany and a distributor network covering five continents. HMS develops, produces and markets intelligent communication technology for automation devices. Its technology, services and products bring value and flexibility to manufacturers and users of automation products. HMS's AnyBus product line includes embedded solutions, serial and Ethernet bridges, gateways, and switches, as well as a full set of development tools.

Website: [www.anybus.com](http://www.anybus.com)

### **innotec GmbH**

innotec offers consulting, training, development support, and project management for companies that produce or use safety-related components or systems. innotec works out safety requirement specifications, V&V-plans, and can help with calculations and simulations according to the IEC 61508 standard. In cooperation with TÜV, innotec can perform concept approvals for safety-related hardware and software.

Website: [www.innotecsafety.de](http://www.innotecsafety.de)

### **Jetter AG**

Jetter AG is a manufacturer of industrial control systems. Being a system provider, the company sells either the entire product range or individual components. Controllers, drive systems, user interfaces, remote-i/o, industrial PCs and automation software are included in the scope of supply. Jetter technology distinguishes itself by optimum integration of all functions, such as motion control, communication via Ethernet, Web-technologies and clear plain-text programming.

Website: [www.jetter.de](http://www.jetter.de)

### **Lenze**

Lenze Group, the international drive and automation specialists, offers innovative products and system solutions for machine building and plant engineering. Employing over 3000 people worldwide, the company produces frequency inverters and servos, automation products including software, motors, geared motors, small drives, clutches and brakes. A comprehensive service from consultation and commissioning through to training and independent plant construction complete the package. Products such as custom engineering ensure economic and efficient solutions for complex drive tasks. In this way Lenze successfully honors its commitment to providing uncompromised quality.

Website: [www.lenze.de](http://www.lenze.de)

### **MESCO**

MESCO realizes complete product development for measurement and automatic control technology. The company's software engineering services include PC programs, real-time operating systems, WEB technology, and industrial communication. Hardware engineering services include tasks with Embedded controller, Embedded WEB servers, DSP technology, EMC, and intrinsic safety. Efficient project development is accomplished by qualified engineers and a consistent application of planning methods.

Website: [www.mesco.de](http://www.mesco.de)

### **MOXA Technologies, Inc.**

Founded in 1987, Moxa is the no. one Industrial Ethernet & Serial communication infrastructure manufacturer in Asia. Moxa's main product categories include Industrial Ethernet Switches, Modbus to Modbus/TCP Gateways, IP-based Video Servers, Industrial Media-converters, and Multiport Serial Boards. Moxa's customers come from any number of fields, including Industrial Automation, POS/Retail, Telecommunications, financial services, security systems, traffic automation, and building automation. In 1997, the company opened its first branch office in China, establishing a worldwide



marketing and sales strategy that now includes offices in Germany and the United States.  
Website: [www.moxanet.com](http://www.moxanet.com)

**Niobrara Research & Development Corporation**

Based in Joplin, Missouri, Niobrara Research & Development Corporation is a manufacturer of industrial communication equipment including protocol translation modules, network interfaces, I/O bus interfaces, specialty modems, smart cables, and accessories for programmable controllers and other industrial automation equipment.  
Website: [www.niobrara.com](http://www.niobrara.com)

**Phoenix Contact Inc.**

Phoenix Contact Inc. develops and manufactures specialized electronic components and connection systems. The company offers a diverse range of products designed for industrial applications including terminal blocks, power supplies, signal conditioners, industrial connectors, and automation systems. Phoenix Contact has U.S. headquarters located in Harrisburg, Pennsylvania and world headquarters in Blomberg, Germany.  
Website: [www.phoenixcon.com](http://www.phoenixcon.com)

**Precision Digital Corporation**

Precision Digital Corporation has been in business for 30 years. Our product line consists of a wide variety of digital display devices, many with Modbus interface capabilities. These products include:  
digital panel meters,  
PID temperature controllers  
multi-input controllers.  
Standard process (4-20 mA) and temperature (T/C & RTD) inputs are available, as well as relay and 4-20 mA output options.  
Website: [www.predig.com](http://www.predig.com)

**ProSoft Technology, Inc.**

ProSoft Technology, Inc. is a US company specializing in the development of in-chassis, protocol interface products for automation platforms, in-rack flow computers, stand-alone gateways and wireless communication networks. Development of the first product started in 1988 under contract to Allen-Bradley. This initial product was a firmware solution providing Modbus Slave communications for the PLC platform. Since then, our product lines have grown to over 400 communication modules supporting more than 50 different protocols as well as our new RadioLinx product line of industrial wireless communication solutions and the ProTalk Q product line Quantum controllers. Our evolution has positioned ProSoft Technology as a world leader in communication solutions.

As part of our on-going effort to solve our customer's communication needs we are continually developing new products for industrial applications. The ProSoft team can quickly develop solutions based on market needs and customer requests. Our commitment is to produce quality products based on our network expertise and provide industry-leading technical support dedicated to resolving your industrial communications challenges.

ProSoft Technology, Inc. is headquartered in California, USA with local offices in Europe, Latin America, and Asia Pacific.

Website: [www.prosoft-technology.com](http://www.prosoft-technology.com)

### **RTI**

RTI (Real-Time Innovations) provides software tools, middleware, and professional services for distributed real-time systems and embedded applications.

For over 10 years, with more than 10,000 seats in use, the ScopeTools product line has been helping embedded system developers produce higher quality, more reliable solutions. The NDDS middleware and tools provide seamless communications and comprehensive tools for distributed, real-time system builders. Our customers span the embedded software industry from aerospace and defense, through networking and communications, to industrial automation and consumer electronics

Website: [www.rti.com](http://www.rti.com)

### **SCADAware, Inc.**

SCADAware, Inc. (known as the Springfield Automation group from 1994 through 2000) is located in Bloomington, Illinois. This experienced force provides product sales, control system integration, software design, service and support. Scadaware specializes in PC-based control systems, field-bus I/O systems, PC-based client server SCADA systems, custom communication drivers and utilities, Custom Software Design, PLC controls and enterprise-level data acquisition and reporting. Most products required to build each system are available from SCADAware, Inc. along with the engineering and programming necessary to complete a turn-key solution.

Website: [www.scadaware.com](http://www.scadaware.com)

### **Schneider Automation**

The Automation Business of Schneider Electric offers a wide range of control solutions for virtually every application. From PLCs and I/O to HMI and programming software, Schneider has the products and expertise to meet your automation needs.

Website: [www.schneiderautomation.com](http://www.schneiderautomation.com)

### **Sealevel Systems**

Sealevel Systems manufactures I/O products to serve customers' serial and digital interface requirements. In 2004, Sealevel introduced SeaI/O™, a modular I/O system that offers selectable connectivity and a wide variety of I/O types for distributed control and data acquisition requirements. An array of configurations is available, each designed for maximum flexibility and easy field wiring. Ordering options allow connection to the host device via Ethernet (Modbus/TCP), RS-485 (Modbus/RTU), USB, or RS-232 (Modbus/RTU). SeaI/O modules are perfect for a wide variety of applications and environments including process control, data acquisition, broadcast automation, security, and facility management. I/O models offer a choice of optically isolated inputs, Reed relay outputs, Form C relay outputs, and TTL interface to industry standard solid state relay racks. Field removable terminal blocks are standard, facilitating fast, flexible field wiring. SeaI/O modules operate from 9-30VDC, and power can be input via terminal block or DC jack. Both table mount and DIN rail mounting options are available, and

configuration is made easy using Sealevel's software tools.

Website: [www.sealevel.com](http://www.sealevel.com)

### **Triangle MicroWorks**

Triangle MicroWorks provides communication protocol software libraries, conformance testing software, protocol gateways, and OPC drivers for industry-standard communication protocols such as Modbus, DNP3 and IEC 60870-5. Its ANSI standard "C" source code libraries are used by equipment vendors to cost-effectively implement Modbus, DNP3, and IEC 60870-5 communication protocols directly in the target hardware. The communication protocol test harness is a Windows application that can easily be configured as a typical master or slave device. Tcl/Tk scripts are available to perform conformance test procedures published by the technical committees of each protocol. The Windows PC-based protocol gateways are used by system integrators and utilities as data concentrators and to translate between communication protocols. A full 21-day evaluation version of the SCADA data gateway and communication protocol test harness applications may be downloaded directly from Triangle MicroWorks' website at [www.TriangleMicroWorks.com/downloads.htm](http://www.TriangleMicroWorks.com/downloads.htm).

Website: [www.TriangleMicroWorks.com](http://www.TriangleMicroWorks.com)

### **WAGO Kontakttechnik GmbH**

Since the foundation of WAGO Kontakttechnik GmbH in 1951, the headquarters has been situated in Minden. Today, WAGO employs more than 3,200 staff and has production sites in Germany, Switzerland, India, and China. Companies and representations assure a worldwide on-site service. For years, the world market leader in spring clamp termination technology has been operating in the field of fieldbus technology. As the first system on the market, the WAGO I/O SYSTEM 750, fieldbus independent I/O modules, allows the design of tailored fieldbus nodes for all relevant fieldbus systems.

Website: [www.wago.com](http://www.wago.com)

### **Weed Instrument Company**

Weed Instrument Company, Fiber Optic Division manufactures the EOTec brand of industrial fiber optic modems for factory automation and process control for customers worldwide. The EOTec 2000 fiber optic modem with Ethernet connectivity offers an economical and reliable platform for PLC communications over fiber optic cable. Industrial grade, DIN-rail mountable modules exchange data via an integrated BUS-system to facilitate expansion and custom configurations. Weed also offers analog and digital fiber optic data links (4-20mA, 0-10V and contact closure), multiplexers, termination kits, test equipment and field support for fiber optic networks. Its products are used in many industries, including oil and gas refineries, industrial chemical plants, cement plants, water/wastewater facilities, pipeline applications, and sub sea drilling applications.

Website: [www.weedinstrument.com](http://www.weedinstrument.com)

## **Appendix B – ZigBee Technology Companies**

Below is a brief description of the companies that are members of the ZigBee trade group as listed on the ZigBee website – [www.ZigBee.org](http://www.ZigBee.org).

### **Promoter Companies**

#### **Ember**

Ember removes the barriers to embedded networking with EmberNet. This self-organizing, self-healing, wireless mesh technology is uncompromisingly robust, secure and easy to use. Optimized for sensing and control applications, the EmberNet networking platform gives forward-thinking companies the means to create products that do more because they communicate better.

For more information, [visit our website](#).

#### **Freescale**

Freescale Semiconductor, Inc., formerly the Semiconductor Products Sector of Motorola, Inc., has a 51-year history in microelectronics. Freescale Semiconductor produces semiconductors for the automotive, consumer, industrial, networking and wireless markets worldwide. Based in Austin, Texas, Freescale Semiconductor has design, manufacturing or sales operations in more than 30 countries. Freescale Semiconductor's 2003 sales were US \$4.9 billion. For more information: [www.freescale.com](http://www.freescale.com)

For more information, [visit our website](#).

#### **Honeywell**

Honeywell is a US\$24-billion diversified technology and manufacturing leader, serving customers worldwide with aerospace products and services; control technologies for buildings, homes and industry; automotive products; specialty chemicals; fibers; plastics; and electronic and advanced materials. Honeywell employs approximately 108,000 people in 95 countries and is traded on the New York Stock Exchange under the symbol HON, as well as on the London, Chicago and Pacific stock exchanges. It is one of the 30 stocks that make up the Dow Jones Industrial Average and is also a component of the Standard & Poor's 500 Index.

For more information, [visit our website](#).

#### **Invensys**

Invensys is a global leader in the management of production and energy resources. We focus on helping customers improve performance and profitability through expertise and technology in four business divisions: Production Management, Energy Management, Development (Rail Systems, Wind Power, and Power Components), and Industrial Components & Systems.

Invensys operates in more than 80 countries, with its headquarters in London.

For more information, [visit our website](#).

### **Mitsubishi Electric**

With 80 years of experience in providing reliable, high-quality products to both corporate clients and general consumers all over the world, Mitsubishi Electric Corporation is a recognized world leader in the manufacture, marketing and sales of a wide range of electrical and electronic equipment. Our products are used in information processing and communications, space development and satellite communications, home electronics, and in fields such as energy, transport and construction.

For more information, [visit our website](#).

### **Motorola**

As the world's #1 producer of embedded processors, Motorola's Semiconductor Products Sector creates DigitalDNA™ system-on-chip solutions for a connected world. Our strong focus on wireless communications and networking enables customers to develop smarter, simpler, safer and synchronized products for the person, work team, home and automobile. Motorola's worldwide semiconductor sales were \$4.9 billion (USD) in 2001. <http://www.motorola.com/semiconductors>

Motorola, Inc. (NYSE:MOT) is a global leader in providing integrated communications solutions and embedded electronic solutions. Sales in 2001 were \$30 billion.

For more information, [visit our website](#).

### **Philips**

Royal Philips Electronics of the Netherlands is one of the world's biggest electronics companies and Europe's largest, with sales of EUR 32.3 billion in 2001.

Philips is quoted on the NYSE (symbol: PHG), London, Frankfurt, Amsterdam and other stock exchanges. Philips Semiconductors, headquartered in Eindhoven, The Netherlands, employs over 33,000 employees in more than 50 countries. With sales of around \$4.4 billion in 2001, Philips Semiconductors is one of the world's top semiconductor suppliers. A global leader in RF technology, Philips Semiconductors offers the key competencies for all wireless technologies such as 802.11, ZigBee and Bluetooth. Besides wireless technologies, our RF knowledge also comes into play for applications that call for wired networks.

Philips Semiconductors is one of the founding members and promoter in the ZigBee Alliance.

For more information, [visit our website](#).

### **Samsung**

Samsung Electronics Co. Ltd. is a global leader in semiconductor, telecommunication, and digital convergence technology. Samsung Electronics employs approximately 64,000 people in 89 offices in 47 countries. Samsung Electronics is the world's largest producer of memory chips, smart card chips, display driver ICs, TFT-LCDs, CDMA mobile phones, monitors, and VCRs. Samsung Electronics consists of four main business units: Digital Media Network, Device Solution Network, Telecommunication Network, and Digital Appliance Network Businesses.

For more information, [visit our website](#).

### **Participant Companies**

#### **3e Technologies International**

For more information, [visit our website](#).

#### **ABB**

ABB (www.abb.com) is a leader in power and automation technologies that enable utility and industry customers to improve performance while lowering environmental impact. The ABB Group of companies operates in more than 100 countries and employs about 146,000 people.

For more information, [visit our website](#).

#### **ADCUS**

ADCUS, Inc. is a fabless semiconductor design company specializing in the design, implementation and commercialization of next-generation micro-controller unit (MCU) technology. ADCUS has entered into a strategic alliance with Advanced Digital Chips, Inc. (AD Chips), a semiconductor design company publicly traded in Korea, to acquire certain rights to AD Chips patented EISC (Extendable Instruction Set Computer) MCU architecture technology. EISC, with its 16/32/64bit+ scalable architecture, offers significant price and performance advantages over Reduced Instruction Set Computer (RISC), the leading microprocessor design architecture. EISC was specifically developed for post-PC digital consumer and telecommunications applications that require high performance, low power consumption delivered at a low price.

For more information, [visit our website](#).

#### **Airbee Wireless**

Airbee Wireless develops and licenses innovative, intelligent software for wireless communications. Its UltraLite™ family of software products is focused on the short range, low power, low data rate spectrum of wireless communications. The technology is embedded on microchips for use in many applications and devices serving the consumer and business marketplace. The company's competitive edge is attributed to utilizing a software approach vs. a hardware approach - enabling it to provide lower cost, greater flexibility and shorter time to market for its customers.

For more information, [visit our website](#).

### **APC**

For more information, [visit our website](#).

### **AMI Semiconductor**

AMI Semiconductor (AMIS) is a world leader in the design and manufacture of semiconductor solutions for the real world. As a widely recognized innovator in state-of-the-art mixed-signal technologies and mid-range digital ASICs including ASIC conversion services, AMIS is committed to providing customers with the optimum cost, quickest time-to-market ASIC solutions. Offering unparalleled manufacturing flexibility and dedication to customer service, AMI Semiconductor operates globally with headquarters in Pocatello, Idaho, European corporate offices in Oudenaarde, Belgium, and a network of sales and design centers located in the key markets of the United States, Europe and the Asia Pacific region.

For more information, [visit our website](#).

### **Analog Devices**

Analog Devices, Inc. is a world leading designer and manufacturer of high-performance integrated circuits used in analog, digital (DSP) and mixed-signal processing applications.

Founded in 1965, Analog Devices has manufacturing facilities in Massachusetts, California, North Carolina, Ireland, Japan, the Philippines and Taiwan and has wholly owned sales affiliates in 12 countries.

Analog Devices integrated circuits can be found in most if not all of the world's fastest growing high-performance electronic markets including;

- Automotive
- Communications
- Industrial/Medical
- Computers
- Consumer Electronics

Analog Devices is positioned to play a lead role in virtually every high growth emerging analog, digital or mixed-signal processing market for the foreseeable future.

For more information, [visit our website](#).

### **Atalum**

Atalum is a pioneer in developing standard-based (802.15.4 and forthcoming ZigBee) wireless solutions specifically designed to fulfill the unique needs of the sensing and control marketplace to enable smart environments (smart homes, smart buildings, smart indoor or outdoor spaces, etc.). Atalum is dedicated to enable people and businesses to be completely free of physical boundaries to do what they need to do. Atalum is a privately

owned, venture-backed company based in Madrid, Spain.

For more information, [visit our website](#).

### **Atmel**

Atmel Corporation, founded in 1984, is a worldwide leader in the design, manufacturing and marketing of advanced semiconductors, including advanced logic, nonvolatile memory, mixed signal and RF integrated circuits.

Atmel is one of the elite few companies capable of integrating dense nonvolatile memory, logic and analog functions on a single chip. Atmel chips are manufactured using the most advanced wafer processes, including BiCMOS, CMOS and Silicon Germanium (SiGe) technologies.

For more information, [visit our website](#).

### **Betronic Design BV**

Betronic Design BV is member of the Betronic Holding BV. The Betronic group consist of a number of companies in Design, Production and Hybrid Circuit manufacturing.

Betronic Design BV is one of the largest privately owned design companies in Europe. Fifty five highly qualified engineers in industrial, mechanical, embedded, and software design are available at Betronic Design. These engineers are working in application teams in consumer, automotive, ASIC and telematic design application areas. ZigBee will be supported from the Home, Networking & Telematics Team. Betronic joined ZigBee as we believe that "no wires" and interoperability are key factors in order to be successful in the Home Automation market worldwide.

For more information, [visit our website](#).

### **Brunelco Electronic Engineering BV**

Brunelco Electronic Engineering BV is a fully independent developers team for electronic products, hardware, software and system design. Our experience covers consumer as well as industrial applications.

We have been using wireless communication techniques in a lot of products we developed over the years.

We believe standardization is a key issue for the success of those products.

Our goal is to help customers integrate ZigBee functionality into their (existing) products and assist them in the realization of smart systems based on wireless network components.

For more information, [visit our website](#).

### **Cambridge Consultants Ltd**

Cambridge Consultants Ltd is one of Europe's leading multidisciplinary innovation companies, employing over 230 people in the design and development of all kinds of consumer and industrial products, ranging from healthcare devices, domestic appliances and telecoms equipment to industrial tools and instruments. It also develops the



machinery on which products are made, and builds complex electronic and software systems for purposes ranging from communications in financial markets to preventive maintenance on the London Underground. CCL provides a range of consultancy services, from training in structured idea management to complete technology audits and strategic planning.

For more information, [visit our website](#).

### **Casient**

Casient is a specialist provider of mesh topology radio networks. Using mainstream and industry standard RF components, Casient's Shoal network products can convert hundreds or thousands of network devices into an efficient and reliable mesh network platform. The Shoal network represents significant advances in the way that mesh networks are created and managed, leading to reduced cost and power consumption. Although initially targeted at applications such as building system controls, the technology is equally applicable to other low bandwidth applications such as industrial controls, street lighting and home automation. Casient is seeking OEM partners keen to license the Shoal technology or enter into co-development opportunities.

For more information, [visit our website](#).

### **Certicom**

Certicom is a leading provider of wireless security solutions, enabling developers, governments and enterprises to add strong security to their devices, networks and applications. Designed for constrained devices, Certicom Developer Toolkits and Security Applications are unsurpassed in delivering the strongest cryptography with the smallest impact on performance and usability.

For more information, [visit our website](#).

### **Chipcon**

Chipcon is a leading fabless semiconductor design and manufacturing company which develops, produces and markets high performance, high quality and cost-effective standard RF-ICs for use in a variety of wireless applications. In addition to applications such as AMR (automatic meter reading), home automation, alarm and security systems, remote keyless entry, remote sensor reading, industrial control systems and advanced toys, Chipcon's products are also ideal for numerous digital audio and voice applications as well as game pads, joysticks and PDAs.

Chipcon's present and future RF-IC products represent years of extensive research activities in designing low-cost, low-power radios in standard CMOS and BiCMOS technologies.

The company also provides turnkey mixed-signal ASIC design and manufacturing services for high-volume products.

For more information, [visit our website](#).

### **Cirronet**

Atlanta-based Cirronet has well over a decade of success in developing innovative wireless data networking and communications products for industrial, OEM and Internet access markets. Primarily employing patented proprietary frequency hopping spread spectrum (FHSS) radio transmission technology, the company's products offer reliable, long range performance and unparalleled immunity against jamming and interference. Cirronet products range from OEM modules to standalone Ethernet and serial modems to complete systems and are FCC certified, UL certified and CE marked, operate in the 900MHz, 2.4GHz and 5.8GHz license-free ISM bands.

For more information, [visit our website](#).

### **Cisco Systems, Inc.**

Cisco Systems, Inc. is the worldwide leader in networking for the Internet. Today, networks are an essential part of business, education, government and home communications, and Cisco Internet Protocol-based (IP) networking solutions are the foundation of these networks. Cisco hardware, software, and service offerings are used to create Internet solutions that allow individuals, companies, and countries to increase productivity, improve customer satisfaction and strengthen competitive advantage. The Cisco name has become synonymous with the Internet, as well as with the productivity improvements that Internet business solutions provide. At Cisco, our vision is to change the way people work, live, play and learn.

For more information, [visit our website](#).

### **CompXs**

Leading the development of wireless connectivity solutions, CompXs continues to innovate system-level solutions based on IEEE 802.15.4/ ZigBee and 802.15.3/ UWB standards. CompXs, a three year old, private, self funded start up, delivered the first working, fully functional demo system for IEEE 802.15.4. Other CompXs firsts include providing IEEE 802.15.4 (2.4GHz) development tools for a ZigBee Alliance Promoter company and delivery of an IEEE 802.15.4 D-18 MAC/PHY solution. With a growing international development team, CompXs continues to pioneer system solutions for Wireless PANs with its modular technology portfolio: IP, SW, silicon, modules and system integration capabilities.

For more information, [visit our website](#).

### **connectBlue**

connectBlue is the leading supplier of complete wireless solutions for industrial and commercial use. We provide our customers with hardware and software solutions, and wireless products. Based on our extensive experience of all the requirements needed to supply the market with cost-effective and timesaving wireless solutions, we are able to

support customers worldwide.

Our staff are world-class professionals who have been involved in the development of Bluetooth® wireless technology since its conception. connectBlue was founded to supply the market with Bluetooth solutions for industrial and commercial use. Today we are recognized worldwide as the leading experts and providers of wireless solutions for professional use.

For more information, [visit our website](#).

#### **Control 4**

For more information, [visit our website](#).

#### **Crossbow**

For more information, [visit our website](#).

#### **CSEM**

Swiss Center for Electronics and Microtechnology, Inc. is a privately held, knowledge-based company carrying out applied research work, product development, prototype and low-volume production, in the fields of microtechnology, nanotechnology, microelectronics, systems engineering, and information systems.

By offering its high-tech know-how, competencies and expertise, CSEM anticipates and fulfils the needs of industrial partners. In particular, it supplies customized microsystems, microelectronic designs and system solutions. CSEM also develops its own commercial activities, either with existing companies or through the creation of start-up companies. CSEM operates from its headquarters in Neuchâtel. It also runs a micro-optics research facility in Zurich and a microrobotics activity in Alpnach, near Lucerne. The company has a staff of some 300 employees, over half of whom hold an academic degree.

For more information, [visit our website](#).

#### **Daintree Networks**

Daintree Networks provides design verification and test tools for developers of wireless sensor and control devices and systems.

For more information, [visit our website](#).

#### **Danfoss**

Danfoss is a global Group with about 17.000 employees. Danfoss has 53 plants in 21 countries and sales companies and agents/distributors in more than 100 countries. We are a customer-focused, worldwide supplier of technological products, services and solutions. We offer solutions within many different areas of application, such as energy conservation, food processing, productivity gains, enhanced comfort and environmental improvements. Danfoss is among the world-leaders within its three business segments: Refrigeration & Air Conditioning, Heating & Water, and Motion Controls.

In our international activities we aim at financial growth and stability in our local companies, and thus contribute to the social and financial development of the countries in which we work. The Group's environmental policy is the basis of Danfoss' position as trend-setter when it comes to environmental responsibility and sustainable development.

For more information, [visit our website](#).

### **TWACS**

DCSI (Distribution Control Systems, Inc.) offers utilities the industry's most sophisticated, yet value-priced, power line communications solution for automating meter reading, improving distribution system efficiency/reliability and adding value-added services. The TWACS<sup>®</sup> system (Two-Way Automatic Communication System) features reliable, high performance AMR, load management, distribution system management, outage management and remote service connect/disconnect applications. Customers include ATCO Electric, Florida Power & Light Co., PPL Electric Utilities, Puerto Rico Public Power Authority, Wisconsin Public Service Co., over 100 Electric Cooperatives, municipal utilities and public utility districts. The FPL TWACS Load Management project is the largest two-way PLC load control project in the world and PPL's AMR deployment is the largest two-way PLC project in North America. There are over 6.5 million units sold or under contract.

For more information, [visit our website](#).

### **Duolog Technologies**

Duolog Technologies a leading provider of intellectual property and embedded software solutions for wireless communication standards including 802.11a/b/g and ZigBee/802.15.4 to semiconductor manufacturers. We also provide networking software to OEMs and System Integrators in commercial, industrial, utility and defense industries. Our highly experienced engineers are familiar with developing at the leading edge of emerging technologies to deliver IP and custom design software and services for high volume products.

For more information, [visit our website](#).

### **Dust Networks**

Dust is a technology company providing low-powered, wireless sensor networks in energy monitoring, building automation and industrial process control applications. We are the layer that connects sensors to systems, providing a cost-effective, industrial-grade platform for linking the physical world with IT systems for purposes of sensing, monitoring, and control. Headquartered in Berkeley, California, Dust employs 20 people and expects that number to grow rapidly.

For more information, [visit our website](#).

### **Eaton Corporation**

Eaton Corporation is a global \$7.3 billion diversified industrial manufacturer that is a leader in fluid power systems; electrical power quality, distribution and control; automotive engine air management and fuel economy; and intelligent truck systems for fuel economy and safety. Eaton has 48,000 employees and sells products in more than 50 countries.

For more information, [visit our website](#).

### **EAZIX**

EAZIX is an electronic R&D company which provides a complete ODM and design service to include system hardware, software, RF solutions, component development (FPGA and ASIC), and mechanical design covering the different stages of a product's life cycle: product development, pre-production (prototyping and product qualification), and manufacturing (production tooling and fixtures, tester development). EAZIX is a joint venture between Integrated Microelectronics Inc., and SIIX Corporation. Integrated Microelectronics Inc. (IMI) is one of the oldest electronics manufacturing service providers in the Philippines providing manufacturing services for electronic products, components and assemblies. SIIX Corporation (SIIX) is a Japanese company engaged as a "Global Business Organizer", with long experience in providing logistics services for electronic components.

For more information, [visit our website](#).

### **ELAN Microelectronics Corporation**

ELAN Microelectronics Corporation was established in May 1994 in Hsinchu Science-Based Industrial Park - the Silicon Valley of Taiwan. ELAN's major business covers research, development and marketing of integrated circuits (IC). Elan technology excels in the design of IC and in the development of software for embedded memory, analog IP, and wireless communication (DSP, Bluetooth). Available products includes consumer IC's, microcontrollers, PC peripherals, and much more. Through R&D team expertise, Elan has been granted with the highest number of patents among its peers in the industry. With its sound technology base, Elan has embarked in forming alliances with prestigious local and foreign business professionals to reinforce its technical ability in achieving breakthrough in the system on a chip (SOC) technology. With such achievements, Elan is now capable of providing total solutions to its customers.

For more information, [visit our website](#).

### **ELDAT**

ELDAT founded 1979 in Berlin/Germany is a leading company which develops and produces high quality and cost-effective, low-power radio and controller devices. Beside our standard products we also develops and manufactures customized radio and controller components or turnkey systems incl. the design, engineering and supply of mechanical parts like housings.

Today our main market is the home and building automation market. Furthermore we are

supplying standard or customized components in other markets like alarm and security, health care, industry and automotive.

We are already following the objective to control and monitor all functions in homes and buildings with one standard radio system.

ELDAT products are used all over the world.

For more information, [visit our website](#).

### **Exegin**

Exegin designs and manufactures microcontroller evaluation boards complete with network interfaces, an open source eCos real time OS, open source protocol stacks and a GNU development environment. The company's products allow developers to start writing application code immediately and get a networked embedded system to market quickly and effectively.

For more information, [visit our website](#).

### **Figure 8 Wireless, Inc.**

Figure 8 Wireless, Inc. is the leading embedded software and networking solutions supplier focused exclusively on standardized wireless communication protocols, including ZigBee, Bluetooth, and 802.11b. Headquartered in San Diego, CA, Figure 8's team has years of experience supporting global OEMs and end customers with wireless products and solutions. Figure 8 is committed to a cost-effective and user-friendly "out-of-the-box" wireless experience.

For more information, [visit our website](#).

### **France Telecom R&D**

France Telecom R&D, the France Telecom Group's research and development center, drives innovation for all Group units in France and worldwide. The center anticipates technological revolutions and paradigm shifts in usage. The center focuses on innovation that provides customers with best-in-class communications solutions, paving the way for technologies that will become ubiquitous in the future.

The performance of France Telecom R&D makes it Europe's leading telecom research and development center.

For more information, [visit our website](#).

### **Fraunhofer-Gesellschaft**

The Fraunhofer-Gesellschaft undertakes applied research of direct utility to private and public enterprise and of wide benefit to society. Its services are solicited by customers and contractual partners in industry, the service sector and public administration. The Fraunhofer-Gesellschaft maintains over 80 research units at more than 40 different locations throughout Germany. A staff of some 12,700, predominantly qualified scientists and engineers, works with an annual research budget of over one billion euros. Of this sum, more than €900 million is generated through contract research. Two thirds of the

Fraunhofer-Gesellschaft's contract research revenue is derived from contracts with industry and from publicly financed research projects. The remaining one third is contributed by the German federal and Länder governments, as a means of enabling the institutes to pursue more fundamental research in areas that are likely to become relevant to industry and society in five or ten years' time.

The Fraunhofer-Gesellschaft is also active on an international level: Affiliated research centers and representative offices in Europe, the USA and Asia provide contact with the regions of greatest importance to present and future scientific progress and economic development.

For more information, [visit our website](#).

### **Frontline**

With over 30,000 sniffers shipped since 1988, Frontline is believed to be the number two supplier of PC-based data communication analyzers. Frontline has emerged as the leader in Bluetooth® analysis. FTS4BT(tm) was the first air sniffer for Bluetooth V1.2 and SerialBlue(r) was the first serial HCI analyzer. Frontlines Serialtest(r) family of RS-232 analyzers has long been considered the “gold standard”. Frontline also produces sniffers for Ethernet, Industrial Automation, and Intelligent Traffic Systems (NTCIP). Frontline products are used by engineers and technicians who develop, test, install, maintain, and repair equipment and instrumentation that is interconnected by a variety of communication technologies.

For more information, [visit our website](#).

### **Golden Power Manufacturing**

Golden Power Manufacturing is a midsized, vertically integrated, electronics manufacturing company located in Guangdong province, Shenzhen city, China.

We specialize in electronics for the mid to upscale consumer. Typically our products are designed in house; however, we do OEM on a project by project basis. Products of our own design include: thermostats, irrigation timers, clocks, phones, ultrasonic cleaners and fans.

We currently have ZigBee products in development in four of the above categories. Our customers have included: Honeywell, Home Depot, Brookstone, Sharper Image, etc. For additional information please contact Mr. Tim Simon in San Francisco, California, 1-415-515-1200 or via email at [ZigBee@timsimon.com](mailto:ZigBee@timsimon.com).

For more information, [visit our website](#).

### **Grundfos**

With an annual production of 8 million pump units, Grundfos is one of the worlds leading pump manufacturers. Circulator pumps (UP), submersible pumps (SP), and centrifugal pumps (CR) are the three major product groups. Today, Grundfos is the world's largest manufacturer of circulator pumps, covering approximately 50 percent of the world market for these pumps. The Grundfos Group is represented by 55 companies in 38 countries. In addition, Grundfos products are merchandised by distributors in a large

number of countries.

For more information, [visit our website](#).

### **Helicomm**

Helicomm provides IP licensing to semiconductor manufacturers, and standards-based, wireless data networking solutions for OEMs and Systems Integrators in commercial, industrial, utility and defense industries. Helicomm's Intelligent Pervasive Wireless Networking Solutions (IPWiNS™) platform is ideal for a wide range of remote monitoring and control applications where reliability, security, scalability and low power are key requirements.

Helicomm's IPWiNS™ platform enables companies to reduce development time and cost, leverage Internet Protocol (IP) and proprietary network investments, increase wireless data network security and reduce total cost of ownership for building and deploying wireless data networks.

For more information, [visit our website](#).

### **Inovonics Wireless**

Inovonics Wireless designs, manufactures, and markets wireless receivers, transceivers, and battery-operated radio transmitters. Since 1986, Inovonics Wireless has been a pioneer and a leader of 900 MHz, spread spectrum technology and has shipped over two million wireless products.

For more information, [visit our website](#).

### **Insta**

In 1970 Insta was founded by Berker, Gira and Jung, three recognized German building installation companies. As electronics technology centre with 550 employees Insta develops and fabricates products not only for the three associated companies, but for many sectors of industry, mainly lighting industry. Insta is competent partner with substantial know-how and innovative application ideas in the development of high-quality serial products. Insta's focus is on conventional installation technology, light management systems, LED-technology, RF systems like instafunk and Bluetooth, building system engineering with instabus(r) EIB / KNX components, other bus systems, digital and analog signal processing, security technology. For many product ranges Insta also offers the development of individual, custom-made solutions.

For more information, [visit our website](#).

### **Institute for Information Industry**

The Institute for Information Industry (III) started from an idea that was commonly shared by the Ministry of Economic Affairs and several private enterprises. The concept of integrating resources from government and private sectors gave birth to the III. Since its inception in 1979, III has been the backbone of research and development for Taiwan's information industry sector, with the aim of improving the productivity and



competitiveness of all industries through the use of IT.

Our extensive network of resources and decades of experience have made us Taiwan's one-stop IT development and promotion source.

For more information, [visit our website](#).

### **Integration Associates**

Integration Associates is a fabless semiconductor company offering high performance analog and mixed-signal semiconductor solutions for wireless and wireline communications. The company designs and manufactures semiconductor solutions for modems, mobile phones, notebook and handheld computers, and numerous other applications utilizing low power, low data rate, data communication. Integration also offers turnkey ASIC development for customers, from initial concept development to high volume production. For RF applications, Integration delivers high performance, low cost, fully-integrated IC solutions to enable reliable one-way data communication and cost-effective wireless networking.

For more information, [visit our website](#).

### **IPcom**

IPcom has been developing prepaid telecommunication systems since 1995. The experience gained in all this time, with installations in 20 countries of America, Africa and Asia, has placed our company at the frontline of development and implementation of complex systems, tailored to our customers' needs.

Paying attention to the different market needs and based on the knowledge acquired during all this time, IPcom has worked on the utilities world through its actihome product.

For more information, [visit our website](#).

### **Itron**

Itron is a leading technology provider and critical source of knowledge to the global energy and water industries. More than 3,000 utilities worldwide rely on Itron technology to deliver the knowledge they require to optimize the delivery and use of energy and water. Itron delivers value to its clients by providing industry-leading solutions for electricity metering; meter data collection; energy information management; demand response; load forecasting, analysis and consulting services; distribution system design and optimization; web-based workforce automation; and enterprise and residential energy management. To know more, start here: [www.itron.com](http://www.itron.com)

For more information, [visit our website](#).

### **Jennic**

Jennic is a leading provider of Intellectual Property and silicon design services to the broadband communications market. Jennic combines its system expertise, advanced

Intellectual Property portfolio and skills in digital, software, mixed-signal and SoC design to deliver performance, cost and time-to-market advantages to its system OEMs and semiconductor customers. Jennics Intellectual Property portfolio includes physical layer framers and bus bridges for wide and metro area networks, access network co-processors, line-card connectivity solutions and cellular, low power wireless and data mixed-signal systems.

For more information, [visit our website](#).

Established in 1991 as a government-funded Institute, under supervision of Ministry of Commerce, Industry and Energy of Republic of Korea, Korea Electronics Technology Institute (hereinafter “KETI”, website: [www.keti.re.kr/e-keti](http://www.keti.re.kr/e-keti)), the leading Research Institute in Korea, strives to globalize core research and business development activities in Electronics, Telecommunication, and Information Technology areas. Moreover, it aims to provide total solution to small and medium sized firms including ventures. For instance, KETI operates its own incubating business center, which includes around 20 spin-off companies at the moment. There are three cores: Research and Development Divisions, Components Division, Nano & Conversion Division, System Division, and Research & Business Development Center.

For more information, [visit our website](#).

### **Korwin**

Korwin, founded in 2000, is a leading provider of Wireless PAN design and solution including Bluetooth, ZigBee/802.15.4 to wireless devices and semiconductor manufactures. Korwin has developed the various Bluetooth technology and devices. Those designs are mass-produced by many manufacturers. Korwin specializes in embedded software solution for wireless devices and designing wireless protocol engine/profile.

The company in Seoul (Korea) is closely connected with Korea Gov. ZigBee projects and many industry-university projects. Korwin continues to sensor networking for pervasive computing and another wireless PAN products including RFID, UWB.

For more information, [visit our website](#).

### **Legrand**

Legrand is the world specialist in products and systems for electrical installations and data networks in residential housing and office buildings and in industry.

The group offers comprehensive solutions including home automation and building automation systems, and in particular:

> electricity and data distribution

panels and cabinets, circuit-breakers, VDI panels and patching racks, cable management

> controls and connections

switches and sockets, installation control via the Internet, power line carrier, infrared and radio

> safety systems for people and property

fire and intruder alarms, emergency lighting, access control  
> solutions for industrial buildings and processes automation cabinets, cabling components, power supplies and transformers

For more information, [visit our website](#).

**LG Electronics, Inc.**

LG Electronics, Inc.(Korea Stock Exchange: 6657.KS) was established in 1958 as the pioneer in the Korean consumer electronics market. The company is a major global force in electronics and information and communications products with more than 64,000 employees working in 76 overseas subsidiaries and marketing units around the world. With annual total revenues of more than US \$16.9 billion (non-consolidated), LG Electronics comprises three main business companies: Digital Display & Media, Digital Appliance, and Telecommunication Equipment & Handset. LG Electronics goal is to enable the intelligent networking of digital products that will make consumers lives better than ever.

For more information, [visit our website](#).

**LUXOFT LABS**

LUXOFT LABS (IBS Group) provides research services and solutions for OEMs, IHVs and System Integrators.

Our innovative MeshNetics™ family - is a comprehensive suite of software components, algorithms, hardware designs and solutions enabling rapid and practical deployment of ad-hoc, mesh sensor networks optimized for sensing and control in Building and Industrial Automation, Security and Surveillance, First Responder, and Machine Health.

ZigBee is an industry standard wireless connectivity platform which enables us to introduce a new generation of user-friendly 'Expert' sensor network applications optimizing business productivity and improving quality of life.

For more information, please contact us at [wireless@luxoft.com](mailto:wireless@luxoft.com)

For more information, [visit our website](#).

**Maximedia**

Maximedia is currently involved in developing a next generation home automation platform known as the Control Easy® System. Based on ZigBee technology, it will feature sophisticated software and hardware that will make building a powerful and expandable home automation system incredibly easy.

For more information, [visit our website](#).

### **MaxStream**

MaxStream is a leading worldwide developer of wireless modem networking for electronic devices. MaxStream's acclaimed 900 MHz and 2.4 GHz radio modems provide long-range data communications, low power consumption and advanced networking capabilities at very low cost. MaxStream products interface with RS-232/485, USB, Ethernet and telephone networks in peer-to-peer, point-to-point and point-to-multipoint topologies.

MaxStream is developing the XBee™ ready-to-use ZigBee mini module. This mini module will be available for original equipment manufacturers to enable their products with ZigBee wireless connectivity.

For more information, [visit our website](#).

### **Melexis**

For over a decade, Melexis has been designing and manufacturing advanced integrated semiconductors, sensor ICs, and programmable sensor IC systems with unique customization and configuration capabilities that meet the stringent requirements of the automotive industry. The company specializes in electronic control applications that require sensors, signal conditioning, signal processing, actuation, and programmability.

For more information, [visit our website](#).

### **Micrel**

Micrel is a leading manufacturer of advanced high-performance analog, mixed-signal and digital ICs. These products include low drop-out and switching voltage regulators, PCMCIA and USB power controllers, high speed communications interfaces, operational amplifiers, comparators, voltage references, power drivers, RF devices, high speed logic and clock management ICs.

Applications for these products include palmtop, notebook and desktop computers, computer peripherals, cellular phones, high speed communications systems, fiber optic communications modules, automatic test equipment, consumer electronics, industrial and process control products and avionics systems. Micrel also designs, develops and markets PHYs, repeaters and switches for Ethernet, Fast Ethernet and Gigabit Ethernet applications.

For more information, [visit our website](#).

### **Microchip**

Microchip Technology Inc. (NASDAQ: MCHP) is a leading provider of microcontroller and analog semiconductors, providing low-risk product development, lower total system cost and faster time to market for thousands of diverse customer applications worldwide. Headquartered in Chandler, Arizona, Microchip offers outstanding technical support along with dependable delivery and quality. Microchip's PICmicro® microcontrollers and related products are ideally suited for cost sensitive ZigBee applications.

For more information, [visit our website](#).

### **Millennial Net**

Millennial Net produces devices and software for creating micro-power, self-organizing wireless sensor networks. Millennial's innovations in protocol and micro-power hardware design extend the reach of automation, telemetry, and security systems without adding wires for signals or power.

Millennial's tiny sensor interfaces - known as i-Beans® - run on low-cost batteries for years, fit anywhere and minimize installation and operating costs. i-Beans self-configure into a unique star-mesh network for reliable, scalable operation. Their small size, power efficiency and fast self-healing allow devices - or the entire network - to be mobile.

For more information, [visit our website](#).

### **Mindteck**

Mindteck is a leading offshore embedded software services company with presence in the US, Europe, Asia Pacific, Middle East and development centers in India and Singapore. Mindteck provides:

- \* Extensive expertise in ZigBee Stack, Application development, Porting and Support on various platforms, which is customized and optimized for your chip
- \* Comprehensive capabilities in embedded software development and wireless technologies to offer you tremendous time-to-market advantage
- \* A services model coupled with the proven offshore advantage to cut down your development costs with zero licensing and royalty fees.

For more information, [visit our website](#).

### **MobilePro**

MobilePro is an emerging company creating scaleable and global wireless technologies and applications. The company has expertise in wireless components technology and intends to leverage that expertise into delivering wireless applications and systems solutions for the global enterprise markets. The company has aligned itself into three operating units. The company's MobilePro Applications Division intends to develop new Wireless Data Network Exchange Service (SM) products for wireless data applications and operational support services such as wireless network monitoring and testing. The company's MobilePro Systems Division intends to provide specialized radio frequency design services for turnkey wireless systems, wireless telemetry systems, solutions that bridge wireless local area networks ("WLAN") and 3G and other wireless web systems. The company's NeoReach Division intends to develop advanced 3G chip technology including 3G modem semiconductor chip sets for hand set telephones, pico-cell base stations, smart antenna technology and advanced radio frequency semiconductors.

For more information, [visit our website](#).

### **Nanotron Technologies**

Nanotron Technologies in Berlin (Germany) has developed the new wireless transmission technology MDMA (Multi Dimensional Multiple Access). This modulation technique is based on chirp pulses and can be applied in all fields of wireless communications. The first product, nanoNET TRX, is a transceiver for the 2.4 GHz ISM band with a data rate of up to 2 MBit/s and a high range of up to 700 meters (outdoors) and 60 meters (indoors), with 10 mW output power, respectively. nanoNET TRX has a very low power consumption and was especially developed for sensor networking, industrial control, home automation, RFID and multimedia at medium data rates.

For more information, [visit our website](#).

### **National Technical Systems**

National Technical Systems (NTS) is a nationally recognized testing laboratory with facilities around the United States. The Computer Testing Division (formerly, XXCAL Testing Laboratories) was formed in 1982 to serve the testing needs of the microcomputer manufacturers and software developers in the areas of quality assurance, programming, compatibility testing and certification, functionality testing, usability testing, test plan development, and documentation. We are one of the oldest and largest independent microcomputer testing companies in the industry, and currently provide services to hardware, software and networking companies worldwide.

For more information, [visit our website](#).

### **NEC**

We will provide solutions through various technological developments and their combination. We will contribute toward growth of the IT society by challenging new technologies. Technical area : System solution, System structuring technology, Software development technology, Know-how in various business models, Appliance Video/audio terminal technology, Network terminal technology, Mobile terminal technology, Device solution technology. IT infrastructure development area : Server technology, IP network technology, Broadband network technology, Wireless network technology.

For more information, [visit our website](#).

### **Niko**

Niko was founded in 1919 and rapidly became the Belgian market leader for switches and outlets. Niko has grown to a company with more than 400 employees.

The complete product range comprises more than 3.500 different products: switch programs, Nikobus home automation system, radio frequency remote control, comprehensive solutions for lighting control, access control etc.

Niko constantly improves and innovates its products, especially to make them even easier to use and install. This is why 'modularity' is used as a key word for our entire product line. Thanks to the advanced technology, Niko is able to develop products that provide the end user with an optimal comfort of living.

"The Touch of Niko" is characterised by top-quality. Apart from constantly striving for impeccable quality and optimal comfort, Niko also attaches great importance to a timeless design.

For more information, [visit our website](#).

### **Novar**

Novar plc is a global business with annual sales of approximately \$2.6 billion. Its Intelligent Building Systems (IBS) sector provides a wide range of high quality, high technology solutions for fire detection and alarm, access control, security, energy management, building controls, and electrical and data connectivity. It supplies around \$1.1 billion of products and services to building operators, contractors, developers, and consumers for use in industrial, commercial, and residential applications worldwide. Employing approximately 6,500 people and operating in more than 30 countries, it is one of the largest businesses in its field.

For more information, [visit our website](#).

### **Oki Electric Industry Co.**

Founded more than a century ago in 1881, Oki Electric Industry Co., Ltd. is Japan's first telecommunications manufacturer, headquartered in Tokyo, Japan. Oki Electric provides customers with top-quality products, technologies and solutions for telecommunications systems, information systems and electronic devices through its corporate vision, "Oki, Network Solutions for a Global Society."

For more information, [visit our website](#).

### **Omron Corporation**

Omron Corporation is a \$5 billion global company whose core competencies are sensing and control. Currently we have five major businesses, organized within an internal company structure - they are Industrial Automation, Electronic Components, Advanced Modules, Social Systems and Healthcare.

For more information, [visit our website](#).

### **One RF Technology**

One RF Technology develops and integrates license-free radio products for data transmission in world-wide applications. The company benefits more than 12 years of expertise in radio-frequency design to provide solutions adapted to its customers' needs.

The product range gathers three families:

- Tiny One is a pre-certified SMD module designed for low cost, low consumption.
- Power One features certified solutions designed for long range operation in harsh environments where reliability is essential.

- Integra One features certified solutions for general purpose with good price-performance ratio.

The powerful firmware embedded in the whole product range allows point to point or network operation, I/O management, frequency hopping and user defined functions. Products are available in light case or water-proof housing.

For more information, [visit our website](#).

### **Orange Logic**

Orange Logic provides the robust embedded software and application software for ubiquitous applications. BeeHive™ solution developed by Orange Logic includes WPAN technology and innovative business model. Orange Logic has various partners cooperating to realize ubiquitous world with ZigBee technology.

For more information, [visit our website](#).

### **OTSL Inc.**

OTSL Inc., headquartered in Nagoya, Aichi, JAPAN, provides customers with embedding software and wireless local area network solutions including ZigBee, Bluetooth, Specified low power radio, and 802.11.

For more information, [visit our website](#).

### **Point Six Wireless**

Point Six Wireless, LLC, founded in 1996, provides OEMs IR and RF end-to-end solutions encompassing Sensor Integration, Packaging, Connectivity and Field Support. Typical deployments include Food and Drug Safety, Energy Management, Traffic Light Automation, and Trucking. A recently announced ZigBee™ Ethernet Gateway allows Point Six ZigBee™ ready devices to communicate via industry standard protocols like, OPC, DDE, XML, and HTML. The Gateway will also archive data for future retrieval and includes alarm and event utilities. A modem based model is offered for applications that lack a suitable broadband connection.

For more information, [visit our website](#).

### **Polaris Networks**

Polaris Networks provides world-class software and software engineering services in leading edge wireless networking technologies such as 802.15.4/ZigBee, 802.11 and 802.16. Whether it is for developing Embedded Software, Device Drivers and Protocol Stacks, or for cutting edge wireless applications, Polaris has proven expertise and track record to help its partners accelerate their product development at a significant savings in terms of time and money. Polaris is an ideal development partner for companies seeking to augment their own R&D resources with experienced and competent engineers to accelerate the time to market and thus gain a significant competitive advantage. Polaris is



located in Bedford, Massachusetts and owns a 10,000 square feet well equipped R&D center in India. Polaris undertakes projects on fixed price basis.

For more information, [visit our website](#).

### **RadioPulse**

RadioPulse is a Being Wireless solution provider that has a vision to make the world better with its innovative wireless technologies. The solution includes wireless transceiver SoC, RF module, and software. The company is one of pioneer developing state-of-the-art solutions for wireless home network, wireless sensor network, wireless AMR, and wireless asset management applications. RadioPulse was founded in April, 2003 and maintains its headquarters & R&D center in Seoul, Korea.

For more information, [visit our website](#).

### **Renesas Technology Corp.**

Renesas Technology Corp. designs and manufactures highly integrated semiconductor system solutions for mobile, automotive and PC/AV markets. Established on April 1, 2003 as a joint venture between Hitachi, Ltd. and Mitsubishi Electric Corporation and headquartered in Tokyo, Japan, Renesas Technology is one of the largest semiconductor companies in the world and world leading microcontroller supplier globally. Besides microcontrollers, Renesas Technology offers system-on-chip devices, Smart Card ICs, mixed-signal products, flash memories, SRAMs and more.

For more information, [visit our website](#).

### **Rincon Research Corporation**

Rincon Research Corporation (RRC) is a Tucson based employee owned company of 100 engineers, scientist, and computer professionals. RRC provides consulting services to various parts of the U. S. Government and others in areas of Digital Signal Processing, Personal Communications, Satellite Communications, Specification development, and concept development for numerous networking technologies.

For more information, [visit our website](#).

San Juan Software provides application development and integration services for ZigBee and other wireless sensor networks. With nearly two decades of experience in embedded system software, the experts at San Juan Software offer a range of consulting services, can collaborate on your software project, or provide full software design and implementation on your hardware.

For more information see our web site: [www.sanjuansw.com](http://www.sanjuansw.com)

For more information, [visit our website](#).

### **SDSystem**

SDSystem (Smart Dream System), formerly SI part of Samsung SDS, has a 14-year history in SI business like dealing in TCS (toll collection systems) with sophisticated vehicle class classification capability, and various control management systems for smooth traffic flow and traffic safety and job site designing and construction of the systems, etc.

SDSystem Co., Ltd. is also developing various home network system products for unified solution of Internet apartments for more than 3 years and received orders of home network system. Our home network system is composed of wire system now, so we replace wire to wireless with ZigBee solution. ZigBee will be a dream technology for wireless home network.

For more information, [visit our website](#).

### **Sensicast Systems, Inc.**

Sensicast Systems, Inc. develops and markets low-power, battery-operable, wireless sensor network solutions for the commercial, industrial, and security industries. The company develops complete end-user solutions and also licenses its Sensicast wireless software framework to OEMs targeted at specific vertical markets. Sensicasts H900 Wireless SensorNet System is the first 802.15.4 like end-to-end wireless mesh networking system for commercial and light-industrial sensing and control applications, including security, building automation, HVAC, and access control.

For more information, [visit our website](#).

### **SHINKO**

SHINKO has been providing total solutions for the backend processing of semiconductors for personal computers, communications devices like mobile phones and digital consumer products.

SHINKO is a world's leading company in the semiconductor packaging and its main products are Plastic Laminated Packages (PLP), Lead Frames, and Glass-to-Metal Seals for optical devices as well as System in Packages (SiP).

In recent years IT networking technologies are drastically evolved to change the human life, so SHINKO is going to develop and manufacture new products by integration of its own core competence for a new era.

For more information, visit our website: <http://www.shinko.co.jp>

For more information, [visit our website](#).

### **Silicon Laboratories Inc.**

Silicon Laboratories Inc. is a leading designer of high-performance, analog-intensive mixed-signal integrated circuits (ICs) for a broad range of applications. Silicon Laboratories' diverse portfolio of highly integrated, patented solutions is developed by a world-class engineering team with decades of cumulative expertise in cutting-edge mixed-signal design. The company has design, engineering, marketing, sales and service facilities throughout North America, Europe, Japan and Asia Pacific. For more

information about Silicon Laboratories please visit [www.silabs.com](http://www.silabs.com).

For more information, [visit our website](#).

### **Silicon Wave**

Based in San Diego, Silicon Wave is a leading provider of low-power, highly integrated RF communication system components for the global wireless market. Silicon Wave products and services include single-chip solutions, stand-alone radio modems, baseband processors, software solutions and a baseband IP licensing program. Founded in 1997, the company was the first to deliver a fully qualified, single-chip radio modem for Bluetooth communications and first to achieve Bluetooth Specification Version 1.1 qualification for its products. Silicon Wave is an Associate Member of the Bluetooth Special Interest Group. The company's Web site is located at [www.siliconwave.com](http://www.siliconwave.com).

For more information, [visit our website](#).

### **Smarthome Inc**

For more information, [visit our website](#).

### **Software Technologies Group**

Software Technologies Group focuses on developing systems level technologies for our OEM partners and their customers. Focusing in the areas of wireless and wired networking and communication protocols, device drivers, specialized applications and interfaces for device and system management and control, STG works with our customers to develop and extend products to meet specific market and customer goals. STG also partners with leading semiconductor manufacturers offering technology licensing and services built around their products to enable them to reach more markets, more effectively.

Founded in 1990, STG provides services across a full spectrum of platforms ranging from embedded environments (including VRTX, eCOS, embedded Linux, TinyOS) to commercial operating systems including 32/64-bit Windows, UNIX, Linux, and MacOS.

For more information, [visit our website](#).

### **STMicroelectronics**

STMicroelectronics is a global leader in developing and delivering semiconductor solutions across the spectrum of microelectronics applications. An unrivalled combination of silicon and system expertise, manufacturing strength, Intellectual Property (IP) portfolio and strategic partners positions the Company at the forefront of System-on-Chip (SoC) technology and its products play a key role in enabling today's convergence markets. The Company's shares are traded on the New York Stock Exchange, on Euronext Paris and on the Milan Stock Exchange (Borsa Italiana). In 2003, the Company's net revenues were \$7.24 billion and net earnings were \$253 million.

Further information on ST can be found at [www.st.com](http://www.st.com)

For more information, [visit our website](#).

### **Stonestreet One**

Stonestreet One is a leading provider of software and engineering expertise to enable short-distance wireless communications. It has expertise in a number of short-range wireless technologies, including 802.11, Ultrawideband, and ZigBee, and is recognized worldwide as a leading provider of Bluetooth software and engineering services. The company's Bluetooth protocol stack, Bluetopia®, is promoted and used by leading chipmakers, distributors, embedded software companies, and leading OEM's in industries including automotive, biomedical, aerospace, mobile communications and consumer electronics. For more information about Stonestreet One please visit <http://www.stonestreetone.com>.

For more information, [visit our website](#).

### **Tattile**

Tattile designs hardware and software for proprietary products and devices created ad hoc to solve the problems of individual customers. The company has its own division that works alongside such giants as INTEL, Analog Devices and SONY, which have chosen Tattile for developing embedded technologies in Italy. The core of our proprietary architecture is an SA 1100 Intel StrongArm proprietary processing system that represents the current state of the art for embedded devices world-wide. The company develops dedicated software applications for its own devices based both on proprietary operating systems and upon commercial operating systems such as Windows CE and Pocket PCs. Software Technology for developing software applications involves various strategies, making use of traditional as well as of innovative solutions for computer systems.

For more information, [visit our website](#).

### **Telecom Italia Lab**

Telecom Italia Lab is the R&D branch of the Telecom Italia Group.

1000 researchers work together to increase innovation and to deliver value to clients of the Group, developing advanced solutions.

Centre of excellence since 1964 in networks and services, Telecom Italia Lab took part in the definition and consolidation of the GSM standard, MP3 and optical transmission.

Today it goes on creating innovation through direct experience in the planning of fixed and mobile access networks, supporting the evolution of the transport network, developing platforms and services, prototyping next generation terminals. Through its laboratories Telecom Italia Lab responds to today's needs of users and industries.

Telecommunications will be a key factor to be competitive on the world market.

Main research areas are: the evolution of mobile communication, from third generation mobile systems to a variety of overlapping wireless networks increasing access flexibility (WiFi, UWB, WiMax, MoFi); the diffusion of broadband...

For more information, [visit our website](#).

### **Telematics Wireless**

Telematics Wireless develops and sells state-of-the-art wireless communication systems and products designed for short range communication, location, monitoring, identification and control. Company's current main product lines include: AMR (Automatic Meter Reading) systems utilizing miniature transceivers for installation in utility meters and associated low-cost readers and repeaters for data collection; AVI and DSRC products used for electronic toll collection (ETC), commercial vehicle operations (CVO), access control, electronic seals for containers etc.; Terrestrial location system utilizing DTOA location technology and spread spectrum communication technique. System components include low-power radio transponders (vehicular, personal or cargo) and Base Stations.

For more information, [visit our website](#).

### **Ten X**

Austin, Texas based Ten X Technology has been providing end-to-end embedded systems solutions to clients ranging from Fortune 500 companies to startups since 1983. Ten X capabilities extend from concept development through high-volume production and cover every aspect of product development and manufacturing. Ten X optimizes time-to-market by providing "Wireless Out of the Box" solutions for rapid integration. 802.15.4 standard form factor solutions include Compact Flash and USB coupled with Gateway solutions to Ethernet, WiFi, Cellular and other IP networks.

- Design: analog, RF, digital, FPGA, software, firmware, industrial design, mechanical engineering, PCB layout, custom packaging, system integration
- Manufacturing: prototyping, pre-production design assistance, complete procurement & manufacturing services, testing, assembly, packaging & shipping
- Support: engineering support production, warranty service, revision control & reliability tracking

For more information, [visit our website](#).

### **Tendril Networks**

Tendril Networks is focused on bringing productivity and ease to application developers on sensor/ZigBee networks. Tendril's service broker is targeted at solving the fundamental architectural problem for application developers -- the complexity of interfacing with hundreds of sensor/ZigBee nodes and the network itself. The service broker, being agnostic to underlying sensor/ZigBee networks, isolates the complexity of different systems allowing the application developer to focus on application-specific programming.

For more information, [visit our website](#).

### **Texas Instruments**

Texas Instruments Incorporated provides innovative DSP and Analog technologies to meet our customers' real world signal processing requirements. In addition to Semiconductor, the company's businesses include Sensors & Controls, and Educational & Productivity Solutions. TI is headquartered in Dallas, Texas, and has manufacturing, design or sales operations in more than 25 countries.

For more information, [visit our website](#).

### **TSC**

TSC, Total Solution for Communications, founded on June 30 of 2003, envisions that TSC is to invent products & solutions which make users "creative, profitable, secure & free".

The pivotal business domain of TSC is Indoor LBS(Location Based Service) and Home Network and its flagship products will be ZBPS(Zone-Based Personalized Service) system and ZigBee network both of which utilize ZigBee technology.

ZBPS solution was nominated for the excellent new technology and brought in fund of US\$ 120,000 by MIC(Ministry of Information and Communication) of Korean government and is on track for commercial development.

ZigBee network which will be first deployed in Home network trial of SKT(SK Telecom) in Korea was established as key development project of TSC as the next generation technology with the fund of US\$ 260,000 by SKT and is currently under implementation. TSC expects total revenue of US\$ 7,250,000 by end of 2004 and will actualize its vision with the fundamentals for marketing and technologies.

For more information, [visit our website](#).

### **UBIWAVE**

UBIWAVE is a leading provider of mesh networking solutions for control and monitoring applications to OEMs, System Integrators and Value Added Resellers.

Ubiwave's customers are large and medium-sized companies in the markets of building automation, factory & process automation and sensor automation.

With our UbiNet technology suite we help our customers to improve their operations costs and comfort by providing robust, secure, self-forming and self-healing wireless solutions. The UbiNet suite comprises of hardware and software components that enable the rapid-prototyping of tailor-made solutions addressing the specific needs of any application. Ubinet can be optimized for reliability, power consumption, low latency or data throughput.

UBIWAVE is a pioneer in making wireless really work, with the development of technologies such as Hot Channel Swapping™ and Plug & Play Meshing™.

For more information, [visit our website](#).

### **Uniband**

Founded in July 2002, Uniband Electronic Corp ([www.ubec.com.tw](http://www.ubec.com.tw)) is an RF IC design house that is headquartered in Taiwan. With experienced RD teams in Silicon Valley, U.S.A. and Hsinchu, Taiwan, Ubec focuses on developing both front-end devices and back-end services that utilize radio frequencies.

Although Ubec is an RF IC design house, we place a high priority on communication with our OEM customers and BB/MAC partners. Being "customer-oriented" has always been the focus of the Ubec Corporation and the people that work there. At Ubec, the customer always comes first.

Ubec is dedicated to offering various RF solutions tailored to our customers' and partners' needs. Our mission is to develop high quality products that have a Low Price-High Performance Ratio while being very quick to respond to the needs of the marketplace. We are devoted to becoming one of the leading IC design houses in the wireless communication industry worldwide.

For more information, [visit our website](#).

### **Vantage Controls**

For over fifteen years Vantage Controls has been a leading manufacturer of automated control and dimming systems for residential and commercial applications. Vantage offers a powerful means to integrate all facility functions into one central system that can be pre-programmed to activate according to a schedule, sensor or button. Simple stylish keypads or touch screens can eliminate entire rows of unsightly switches. The complete system interconnects via a wireless RadioLink (RF) network or with a simple, non-polarized two-wire bus making Vantage products the easiest to install, and the most versatile and trouble free available. Headquartered in Orem, Utah, Vantage distributes its products through a worldwide network of certified representatives, dealers and installers.

For more information, [visit our website](#).

### **VIA Networking Technologies Inc.**

Established in 2002, VIA Networking Technologies Inc. is a leading developer of networking silicon technologies, with a broad product portfolio including Ethernet Networking Controllers, Network Switch Controllers, and PHY-controllers, delivering Fast and Gigabit Ethernet networking connectivity through standard and fibre optic technology for home and corporate applications, as well as 1394 and wireless solutions to meet growing market demand. With over seven years of experience in Networking product development, VIA Networking remains committed to developing leading edge products that feature premium quality, combined with careful attention to our customers needs in whatever we do.

For more information, [visit our website](#).

### **Westmoreland Engineering**

Westmoreland Engineering is a professional corporation developing solutions in the WSN (Wireless Sensor Network) market. We expect there to be explosive growth in the

WSN market and believe that IEEE 802.15.4 and ZigBee will positively impact the future of wireless networking and monitoring of physical phenomena. Headquartered in San Jose, CA, Westmoreland Engineering is a small company that expects to grow with the WSN market and is excited to be a part of the ZigBee alliance.

For more information, [visit our website](#).

### **XEMICS**

XEMICS is a leading fabless semiconductor company specializing in ultra low-power wireless connectivity solutions for personal area networks and home automation. XEMICS is a world leader in innovative IC design technology for highly complex ultra low-power mixed signal circuits. The main product lines are RF transceivers operating in the ISM band including low-power Bluetooth™, data acquisition products, and Audio CODECs.

XEMICS products are used in home appliances, wireless headsets for mobile phones, domestic and industrial environmental monitoring as in wireless security systems, climate control and utility metering. XEMICS products are a 'one stop shop' for connecting the world to the networks.

For more information, [visit our website](#).

### **Yamatake Group**

11 Japanese subsidiaries and 16 overseas affiliates form the Yamatake Group. Yamatake conducts research and development of IA (Industrial Automation), BA (Building Automation), and CP (Control Products) systems and products which are manufactured, marketed and distributed through our worldwide network.

Company Name: Yamatake Corporation  
Founded: December 1, 1906  
Incorporated: August 22, 1949  
Paid-in Capital: ¥10,522 million  
Employees: 5,787 (as of April, 2004)  
Headquarters: Totate International Bldg.  
2-12-19 Shibuya, Shibuya-ku, Tokyo, Japan 150-8316  
Tel: +81-3-3486-2111

For more information, [visit our website](#).

### **ZMD**

ZMD provides expert design, manufacturing and marketing of high performance, low power analog and mixed-signal ASIC and ASSP solutions. As a leading provider of application specific integrated circuits, the company is committed to providing best-in-class products and services with a focus on portable, sensor and wireless applications. With design and sales operations located throughout the world, ZMD offers an unbroken value chain from concept through production. ZMD was founded in 1961 and is based in Dresden, Germany.



For more information, [visit our website](#).

## **Appendix C – DALI Technology Companies**

### **Architectural Energy Corporation**

Consulting services and building control software.

<http://www.archenergy.com>

### **BTicino**

BTicino is an Italian company. BTicino's corporate mission is based upon the development, distribution and integration of electrical functions worldwide, combining state-of-the-art technology and sophisticated design. BTicino can thus innovatively meet the installation requirements of users from over 60 countries, developing different practical and aesthetic solutions for different living styles.

BTicino - part of the Legrand group since 1989 - is one of the world's leading manufacturers of low-voltage electrical appliances. To ensure continuity and the constant innovations of its products' performances and design, it invests over 5% of its turnover in research and development. It has 13 plants and more than 5,000 employees worldwide. BTicino produces over 5,000 products, which can be grouped in three large families: civil installations (in building for light, and sound, temperature and security control), communication in buildings (voice, data and image diffusion), and energy distribution.

<http://www.bticino.com>

### **Delmatic**

Delmatic produces a Lonworks to DALI gateway.

<http://www.delmatic.com/deli.htm>

### **Dynalite**

[http://dynalite-online.com/html/DALI\\_intro.htm](http://dynalite-online.com/html/DALI_intro.htm)

### **Eensors Inc.**

Eensors produces a DALI/Internet gateway.

[http://www.eesensors.com/ES05\\_announce.html](http://www.eesensors.com/ES05_announce.html)

### **GITRONICA S.p.A.**

Gitronica belongs to the Guzzini Group, and since 1990 it has been designing and manufacturing innovative electronics destined for consumer applications, specifically conceived to satisfy any customer's needs.

Gitronica is very active in the lighting world thanks to its comprehensive range of electronic transformers for low-voltage halogen lamps and electronic ballasts for fluorescent lamps - both standard and custom-built products. The high performance level and extreme reliability of Gitronica's products are the result of professional know-how

and fully-equipped laboratories.

Moreover, Gitronica is widely renowned for supplying electronic components to some of the most prestigious companies operating in the field of electric house-hold appliances.

<http://www.gitronica.it>

**Hadler GmbH**

<http://www.hadler-gmbh.de>

**Hüco electronic GmbH**

HÜCO is a manufacturer of lighting electronic components and lighting electronic systems with head quarter in Espelkamp (Germany) and a subsidiary in Limavady (Northern Ireland). HÜCO has worldwide business activities.

DALI activities: manufacturing of electronic ballasts, dimmers, control equipment.

<http://www.hueco.com>

**iLight Group Ltd.**

The iLight Group has been in the business of manufacturing dimmers and lighting controls for over 30 years.

Our 23,000 sq. foot factory in Cwmbran, South Wales is ISO 9001 accredited, and is fully equipped for the development, manufacturing and testing of a comprehensive range of lighting control products, with a wide range of applications.

The group markets two brands. Zero 88 Lighting products are sold through dealers and distributors around the world with the core focus being lighting control for entertainment and leisure. The iLight brand has a range of architectural lighting products from single channel dimmers through to comprehensive controls for complete buildings.

We have extensive experience of and are actively involved in the development of all the major communications protocols including DMX, Ethernet, RDM, CanBus and DALI.

DALI-Activities:

Developing and manufacturing lighting control equipment including dimming units, panels, user interface panels, gateways and programming tools.

<http://www.iLightgroup.com>

**Infranet Partners**

<http://www.infranet-partners.com/>

**International Rectifier**

<http://www.irf.com/>

### **Insta Elektro GmbH & Co. KG**

Insta is the partner company of Berker, Gira and Jung, three well-known companies of the installation industry. As electronic technology centre Insta develops and manufactures for the three partner companies as well as for the lighting industry.

With founded know-how and innovative application ideas Insta is known as a competent partner for developing first class series products and individual customized solutions.

DALI activities:

Developing and manufacturing of control equipment, central units, panels, programming tools, presence detector, brightness sensor, electronic ballast for TC- fluorescent lamps, 1- and 2-lamp, gateways for other bus systems.

<http://www.insta.de>

### **LUXMATE Controls GmbH**

LUXMATE is a young, dynamic growing company which is specialized in light & room management. Headquarter in Dornbirn/Austria and additional establishment in Frankfurt and London.

DALI activity: a sortiment of electronical ballasts; additionally LM-DALI-Gateway and different daylight dependent devices.

<http://www.luxmate.com>

### **NIKO N.V.**

<http://www.niko.be>

### **OSRAM**

OSRAM is one of the leading lighting manufacturers of the world with a leading position in Electronic Control Gears (ECGs). Global turnover is more than 4.3 billion Euros with more than 32000 employees. OSRAM has moved from a classical light bulb manufacturer to a modern High Tech Company. Already 25 percent of OSRAM's turnover is made with Semiconductors (esp. LED), ECG as well as electronic controlled lamps. This ratio will increase to approximately 50 percent until the year 2005. OSRAM has influenced and promoted the new digital standard in lighting control DALI (Digital Addressable Lighting Interface).

Full range of dimmable and non dimmable Electronic Ballasts inclusive lamps. All dimmable ballasts with DALI – or 1...10V – interface. Moreover a big range of control equipment for lighting management.

[www.osram.com](http://www.osram.com)

### **OY Helvar AB**

Helvar is a manufacturer of lighting components and lighting control systems with its headquarters in Helsinki, Finland. Helvar has three factories, two in Finland one in UK and has business activities all over the world.

DALI activity: manufacturing of electronic ballasts, control equipment, panels, sensors, dimmers, gateways to other bus systems.

<http://www.helvar.com/offering> (ballasts)

<http://www.helvar.co.uk> (control equipments)

### **Philips Lighting B.V.**

Product Offering: Full range of Electronic Ballasts for Fluorescent Lamps with DALI compatibility

Contact Person:

<http://www.philips.com>

### **Thorpe PLC**

Mackwell is a leading manufacturer of emergency lighting ballasts and is part of the F.W. Thorpe group of companies.

DALI activities: Development of DALI emergency ballasts and control systems in conjunction with Thorlux Lighting.

<http://www.thorlux.com/group>

### **TridonicAtco GmbH & Co KG**

Tridonic is a worldwide present producer of lighting components and lighting control equipment based in Dornbirn, Austria. Tridonic is represented on the global markets by own operations and a huge network of agents and partners. The Tridonic Atco Group includes further activities in Europe, Australia, Asia, Africa, and on the American continent.

Tridonic already has available a broad range of the DALI controllable electronic ballasts PCA one4all for T8 lamps, T5 lamps and most common compact fluorescent lamps as well as control units for DALI solutions. The range will shortly be extended by DALI controllable electronic transformers and intelligent DALI programming software.

<http://www.tridonicatco.com>

### **Vossloh-Schwabe Deutschland GmbH**

Vossloh-Schwabe belongs to the worldwide leading manufacturers of components for the lighting industry. With production plants in Germany, France, Italy, India, Thailand and Tunisia VS responds flexibly to changing market needs and offers solutions tailored to meet the global lighting industry's requirements. The comprehensive range of quality products covers transformers, ignitors, lampholders as well as electromagnetic and

electronic ballasts including dimmable electronic ballasts for compact fluorescent lamps with DALI interface.

<http://www.vossloh-schwabe.de>

### **Watt Stopper**

Range of controllers and occupancy sensors.

<http://www.wattstopper.com/>

### **WILA**

WILA has entered the new Millennium with a new strategic focus. We are in the process of transforming the firm into an international brand-name company that offers its customers intelligent lighting solutions for the working environment of the 21st century. WILA's core area of competence for the future is called Ergonomie21. As a company with an international focus, WILA's principle markets are Europe, Asia and North America.

The WILA Ergonomie21 concept focuses on the individual in the working environment of the 21st century. WILA develops intelligent ergonomic lighting solutions, designed to meet the needs of individual work places and specific environments. The WILA brand stands for the optimal combination of lighting quality, lighting management, design and aesthetics. Our customers profit from the cost effectiveness, environmental friendliness and safety of our lighting solutions. The WILA brand fully lives up to this comprehensive range of standards. WILA's ergonomic lighting forms the basis for health and a sense of wellbeing at work. In other words, we provide the essentials for motivation and high-performance in modern working environments. WILA's aim is to support outstanding achievement with motivating and health enhancing lighting. We create professional lighting for professionals.

DALI activity:

Developing and manufacturing a sortiment of different daylight depending luminaire- and room management devices.

<http://www.wila.com>