

Presented at the IEEE Industry Applications Society Conference, October 7-12, 1990, Seattle, WA.

Fenestration Systems as Luminaires of Varying Candlepower Distribution

Konstantinos Papamichael
Windows and Daylighting Group
Applied Science Division
Lawrence Berkeley Laboratory
1 Cyclotron Road
Berkeley, California 94720

October 1990

This work was supported by the Robert Thunen Memorial Scholarship of the Golden Gate Section of the Illuminating Engineering Society of North America and the Assistant Secretary for Conservation and Renewable Energy, Office of Building Technologies, Building Systems and Materials Division of the U.S. Department of Energy, under Contract No. DE-AC03-76SF00098.

Fenestration Systems as Luminaries of Varying Candlepower Distribution

Konstantinos Papamichael

Department of Architecture
University of California
Berkeley, California 94720

Introduction

When designing a fenestration system, it is often required to determine its luminous performance, that is the way it allows daylight to enter the space and contribute to the required illumination levels. This can be achieved either through use of scale models or through computer simulation. Each approach has advantages and disadvantages.

On one hand, scale models allow the simulation of the luminous performance of any fenestration system, including consideration of outdoors and indoors parameters, such as exterior and interior obstructions, space geometries and surfaces' reflectance. However, the construction of scale models is time consuming and expensive. Parametric studies require the use of many models, or a sophisticated, changeable one. Moreover, the use of scale models requires appropriate luminous source(s) to simulate the light from the sun, sky and ground, dictating testing under real or simulated sky conditions, which introduces additional limiting issues: real sky conditions are beyond the designer's control and simulated ones require highly sophisticated and expensive facilities.

On the other hand, computer simulation techniques offer flexibility and speed, especially for parametric studies. The continuously decreasing cost of computing power has led to increasingly sophisticated daylight analysis tools with powerful modeling capabilities. However, there are still limitations in modeling fenestration systems that incorporate optically complex components, such as slat-type shading devices, solar screens, drapes, etc. Modeling techniques to handle optically complex environments, such as ray-tracing, become time consuming and require expensive hardware.

Simulation of the performance of electric lighting systems has been successfully handled using computers, since electric lighting systems have a constant luminous output with respect to intensity and spatial distribution, usually referred to as candlepower distribution, which can be measured and used conveniently. This paper describes an approach of treating fenestration systems as luminaires of varying candlepower distribution, so that the determination of their luminous performance becomes consistent with that of electric

lighting systems. The transmitted distribution through fenestration systems due to radiation from the sun, sky and ground is determined from their bidirectional transmittance and the luminance distribution of the sources of radiation. The approach is demonstrated using the experimentally determined bidirectional transmittance of a diffusive sample under the uniform, CIE overcast and CIE clear sky luminance distributions.

Proposed Approach

The bidirectional transmittance $\tau(\theta_o, \phi_o; \theta_i, \phi_i)$ of fenestration systems is defined [IES 1981] as the ratio of the transmitted flux collected over an element of solid angle surrounding the outgoing direction specified by the angles θ_o and ϕ_o to essentially collimated incident flux incoming from the direction specified by the angles θ_i and ϕ_i (Figure 1):

$$\tau(\theta_o, \phi_o; \theta_i, \phi_i) = \frac{dL_o(\theta_o, \phi_o)}{dE_i(\theta_i, \phi_i)} \quad [\text{sr}^{-1}], \quad (\text{Equation 1})$$

where $dL_o(\theta_o, \phi_o)$ is the element of luminance resulting from the transmitted flux and $dE_i(\theta_i, \phi_i)$ is the element of the incident illuminance, normal to the incoming direction.¹

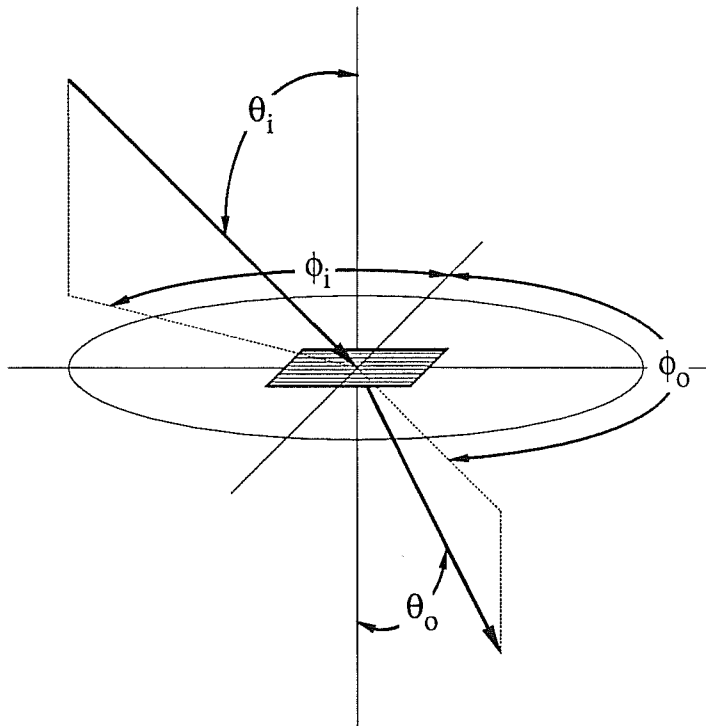

Figure 1. Definition of angles for bidirectional transmittance.

-
1. E_i is defined as the illuminance in front of the fenestration system normal to the incoming direction instead of incident on the fenestration system, in order to cover devices that transmit radiation incoming at 90° incident angle, such as overhangs and awnings.

Once the bidirectional transmittance of a fenestration system is known, it can be used in integration over an outdoors source such as the sky or ground, to determine the directional distribution of the transmitted flux outgoing from the fenestration system. The illuminance in front of the fenestration system, normal to the incoming direction specified by the angles θ_i and ϕ_i , due to a source element is

$$dE_i(\theta_i, \phi_i) = L_i(\theta_i, \phi_i) \cdot d\Omega_i \quad [\text{lumens} \cdot \text{ft}^{-2}], \quad (\text{Equation 2})$$

where $L_i(\theta_i, \phi_i)$ is the luminance of the source element and $d\Omega_i$ is the solid angle of the source subtended at the fenestration system. The element of outgoing luminance $dL_o(\theta_o, \phi_o)$, resulting from the transmitted flux can then be expressed using Equation 1 and Equation 2 as

$$dL_o(\theta_o, \phi_o) = \tau(\theta_o, \phi_o; \theta_i, \phi_i) \cdot L_i(\theta_i, \phi_i) \cdot d\Omega_i \quad [\text{lumens} \cdot \text{ft}^{-2} \cdot \text{sr}^{-1}], \quad (\text{Equation 3})$$

and the outgoing luminance $L_o(\theta_o, \phi_o)$ due to radiation from the whole incoming hemisphere can be expressed as

$$L_o(\theta_o, \phi_o) = \int_{2\pi} \tau(\theta_o, \phi_o; \theta_i, \phi_i) \cdot L_i(\theta_i, \phi_i) \cdot d\Omega_i \quad [\text{lumens} \cdot \text{ft}^{-2} \cdot \text{sr}^{-1}]. \quad (\text{Equation 4})$$

The outgoing intensity $I_o(\theta_o, \phi_o)$ can be expressed in terms of the outgoing luminance $L_o(\theta_o, \phi_o)$ as

$$I_o(\theta_o, \phi_o) = L_o(\theta_o, \phi_o) \cdot dA \cdot \cos\theta_o \quad [\text{lumens} \cdot \text{sr}^{-1}]. \quad (\text{Equation 5})$$

This candlepower distribution of the fenestration system can then be used to calculate indoors illuminance and luminance values as if it were the candlepower distribution of an electric lighting luminaire, either mounted on the ceiling for the case of skylights, or on a side wall for the case of vertical windows.

While it is possible to determine the actual candlepower distribution of fenestration systems, it is more convenient to determine the transmitted distributions as functions of the incident radiation on the exterior of the fenestration system, due to direct solar radiation, diffuse solar radiation from the sky and diffuse solar radiation from the ground.

The transmitted distribution due to the direct solar radiation can be determined directly from the bidirectional transmittance of the fenestration system as²

$$T_{\text{sun}}(\theta_o, \phi_o) = \frac{\tau(\theta_o, \phi_o; \theta_i, \phi_i)}{\cos\theta_i} \quad [\text{sr}^{-1}]. \quad (\text{Equation 6})$$

2. The division by $\cos\theta_i$ is necessary to normalize the transmitted distribution to the incident illuminance rather than the illuminance normal to the incoming direction that is used for the definition of the bidirectional transmittance.

The transmitted distributions due to diffuse radiation from the sky and the ground can be determined through integration over the sky and ground respectively. The transmitted distribution due to radiation from the sky, for a vertical window would then be:

$$T_{\text{sky}}(\theta_o, \phi_o) = \frac{\int_{\pi} \tau(\theta_o, \phi_o; \theta_i, \phi_i) \cdot L_{\text{sky}}(\theta_i, \phi_i) \cdot d\Omega_i}{\int_{\pi} L_{\text{sky}}(\theta_i, \phi_i) \cdot d\Omega_i} \quad [\text{sr}^{-1}], \quad (\text{Equation 7})$$

where $L_{\text{sky}}(\theta_i, \phi_i)$ is the luminance distribution of the sky, usually normalized to the luminance of the sky zenith. For a uniform sky, or for the ground, which is usually considered of uniform luminance, Equation 7 would become:

$$T_{\text{sky}}(\theta_o, \phi_o) = \frac{\int_{\pi} \tau(\theta_o, \phi_o; \theta_i, \phi_i) \cdot d\Omega_i}{\int_{\pi} d\Omega_i} \quad [\text{sr}^{-1}]. \quad (\text{Equation 8})$$

For skylights, there would be no ground component, and the integration over the sky in Equation 7 and Equation 8 would be over 2π .

Demonstration

The proposed approach is demonstrated using the experimentally determined bidirectional transmittance of a diffusing sample for 0° , 15° , 30° , 45° , 60° and 75° incident angles [Papamichael et al. 1988], shown in Figures 2 through 7.

A computer program named SSGTD (Sun Sky Ground Transmitted Distributions) was developed as an application of the method. SSGTD produces the transmitted distributions through a fenestration system due to direct solar radiation, due to diffuse solar radiation from the sky and due to diffuse solar radiation from the ground, under the uniform, the CIE overcast [CIE 1970] and the CIE clear [CIE 1973] luminance distributions.

Using the bidirectional transmittance of the diffusing sample mentioned above, several sample suns of the SSGTD computer program have been made for a vertical window. Samples of the results are shown in Figures 8 through 14.

Conclusion

The proposed approach seems to be promising. However, its validity and utility have yet to be determined. The computer program SSGTD will be used with the lighting analysis computer program SUPERLITE [Kim et al. 1986] to validate the proposed approach and identify its limitations. Depending on the area of the fenestration system, it may be necessary to consider it by separating it into smaller, individual components.

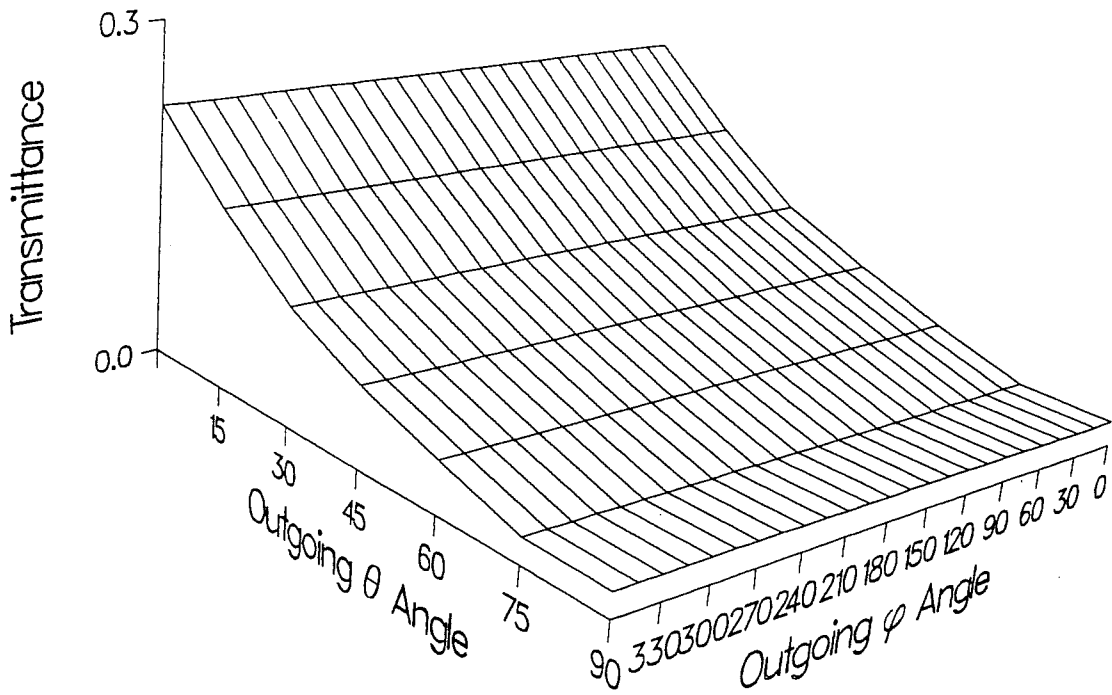

Figure 2. Transmitted distribution through a diffusive sample for 0° incident angle.

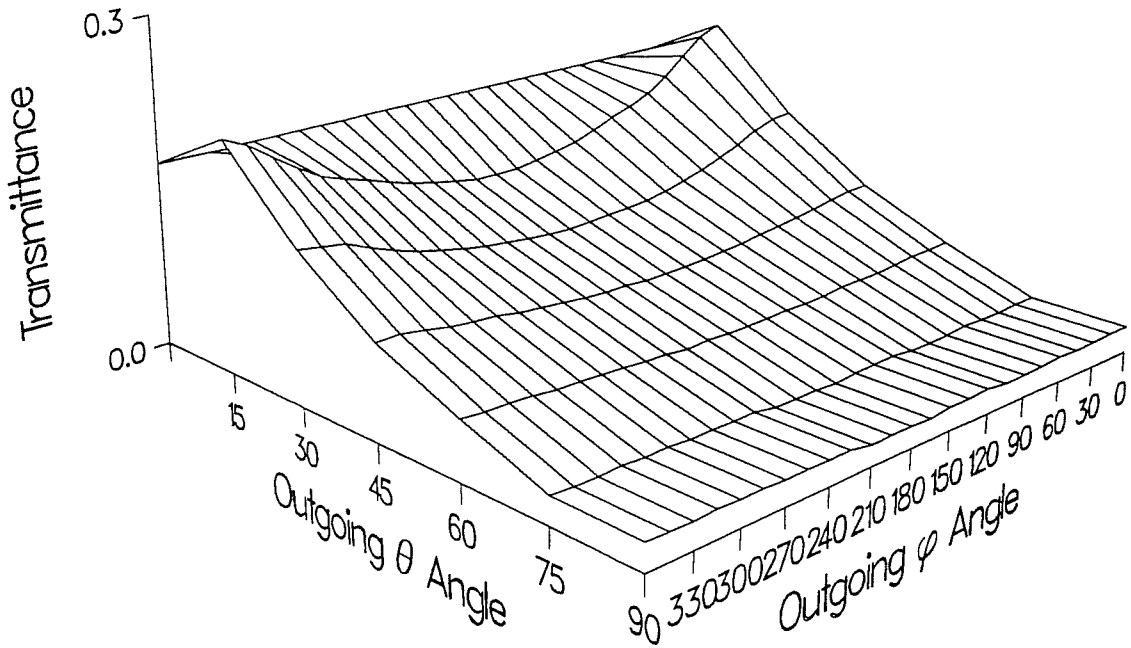

Figure 3. Transmitted distribution through a diffusive sample for 15° incident angle.

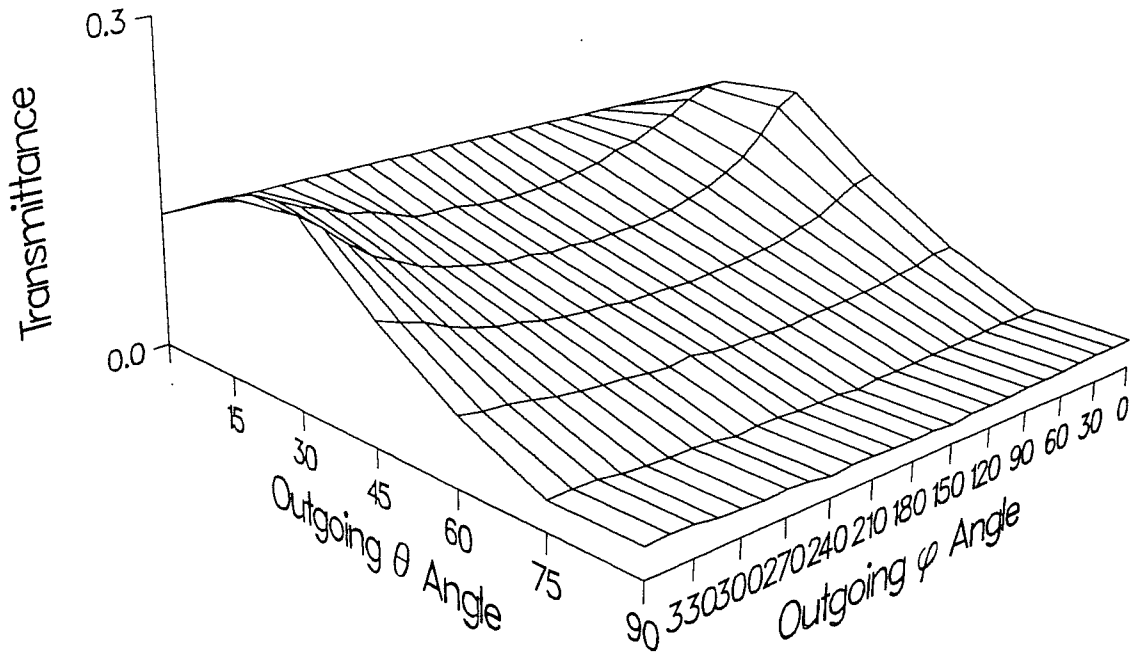

Figure 4. Transmitted distribution through a diffusive sample for 30° incident angle.

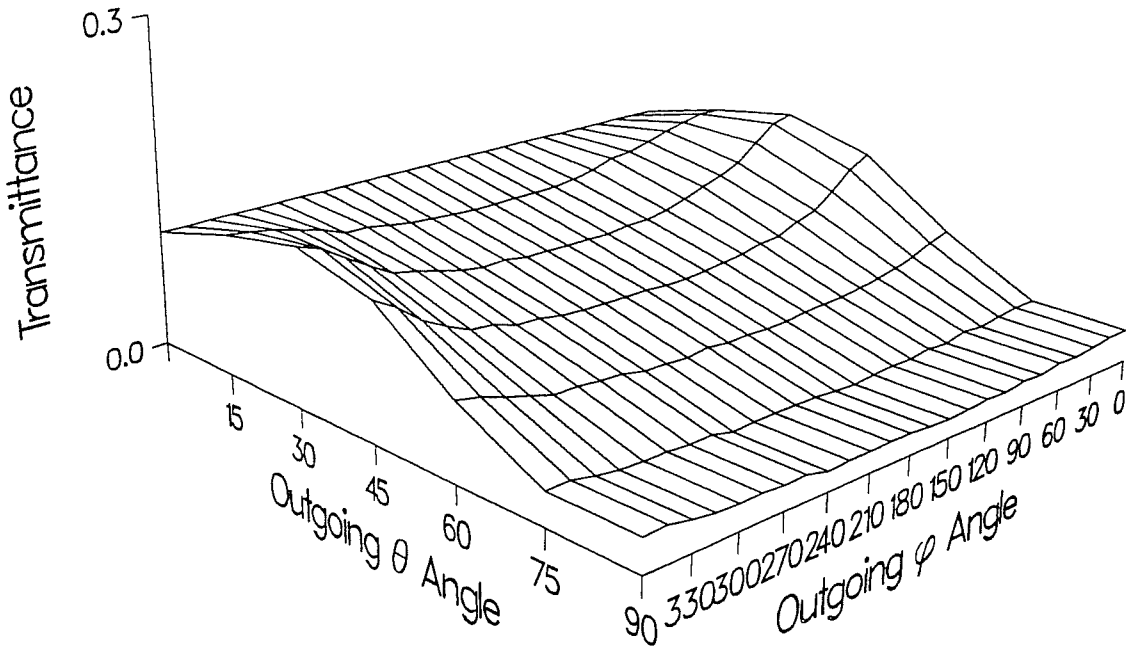

Figure 5. Transmitted distribution through a diffusive sample for 45° incident angle.

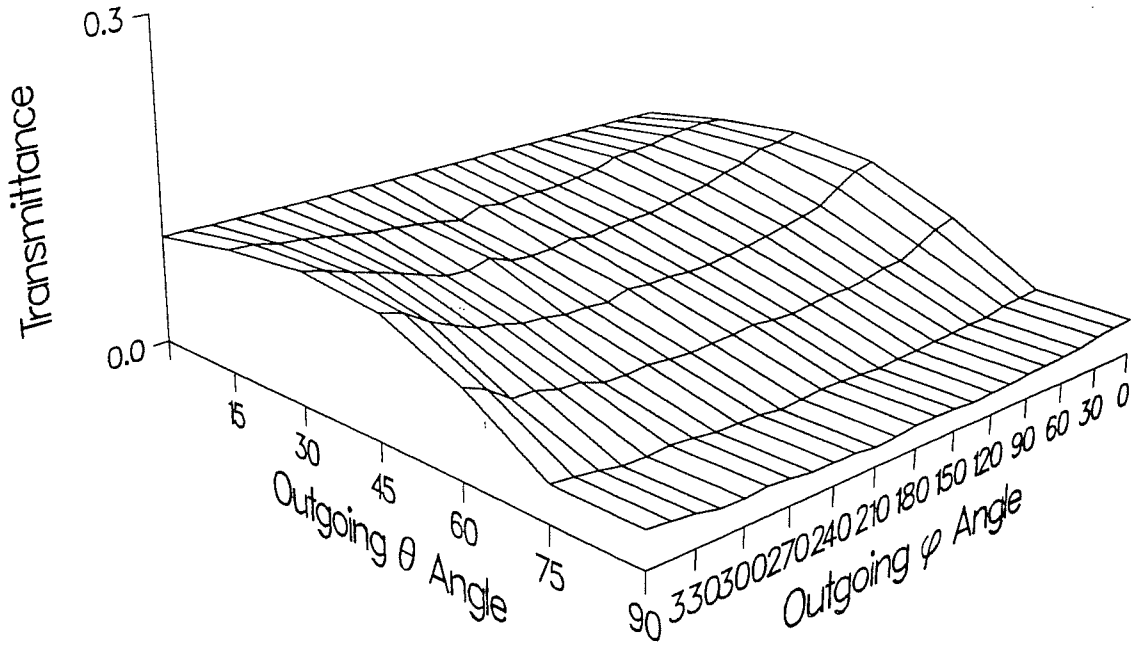

Figure 6. Transmitted distribution through a diffusive sample for 60° incident angle.

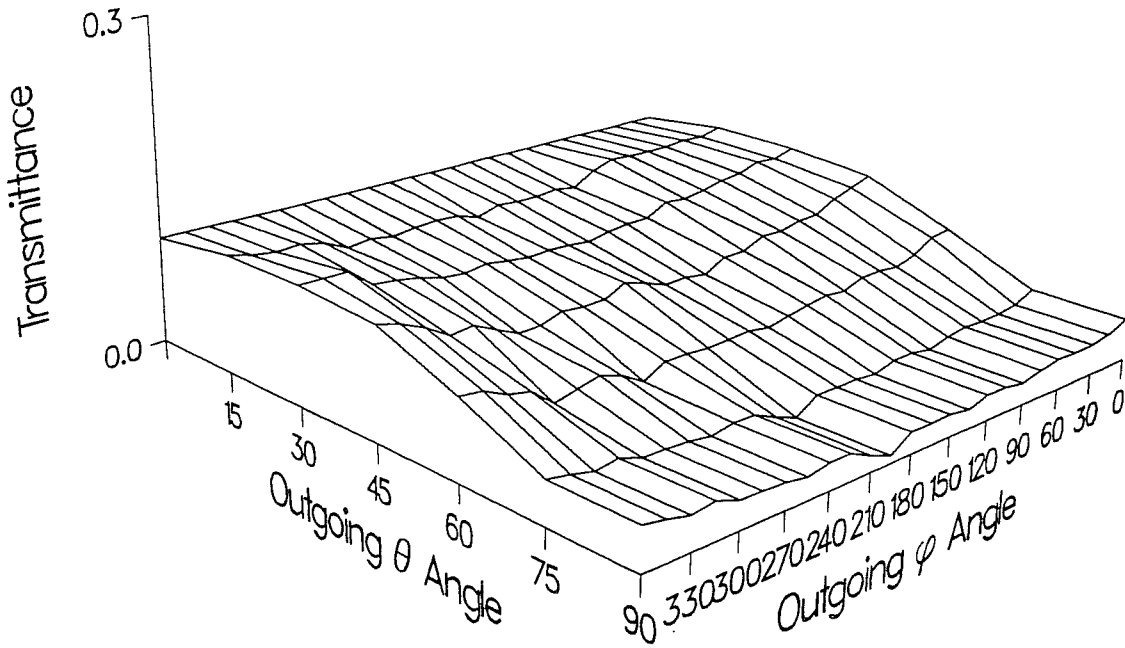

Figure 7. Transmitted distribution through a diffusive sample for 75° incident angle.

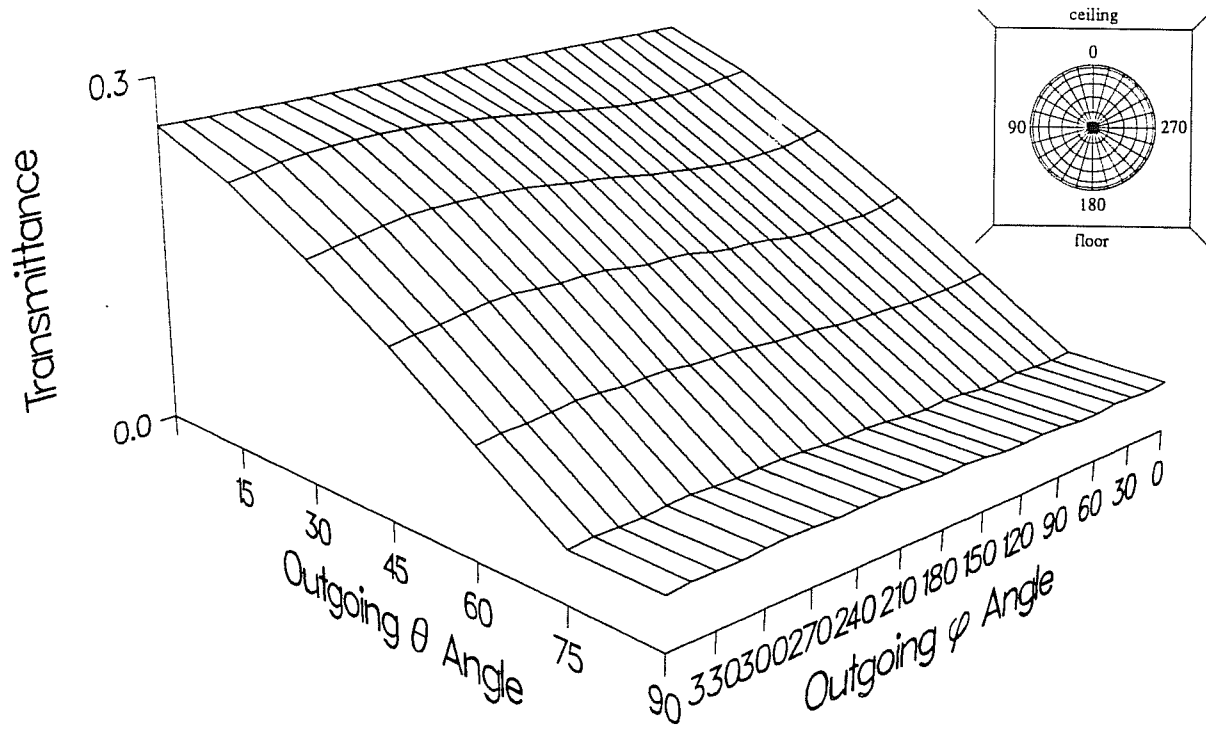

Figure 8. Transmitted distribution through a diffusive sample due to radiation from the ground, assuming uniform ground luminance distribution.

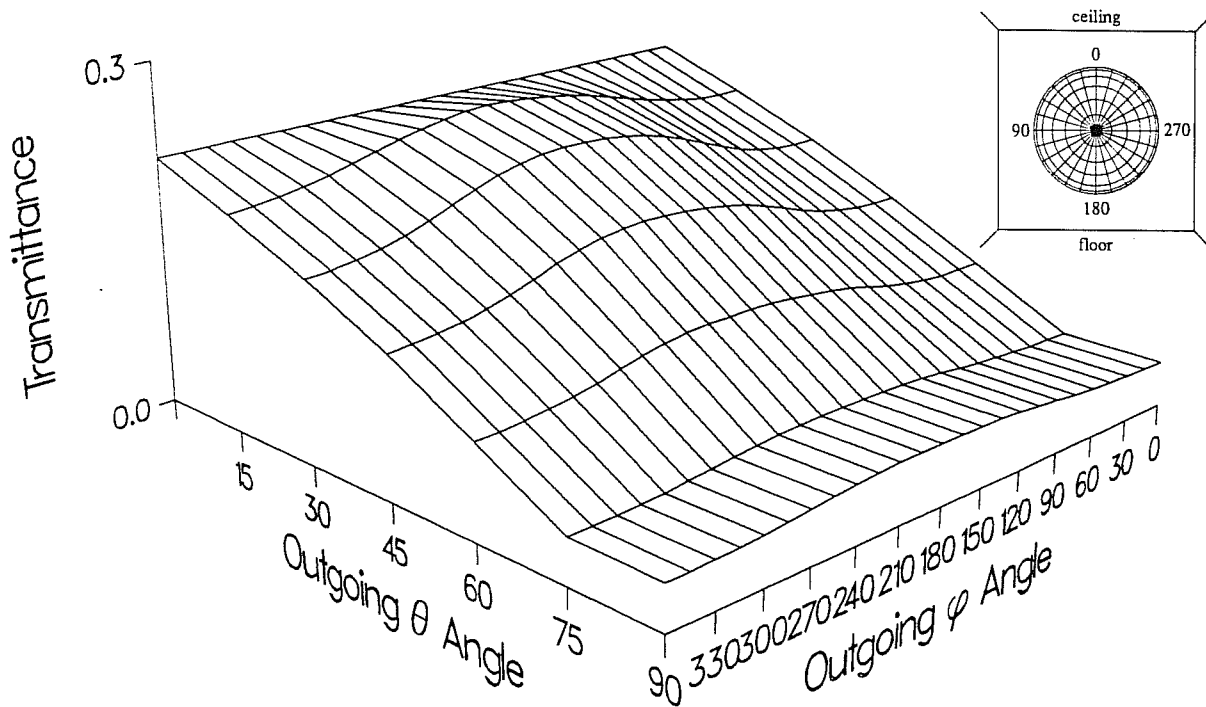

Figure 9. Transmitted distribution through a diffusive sample due to radiation from the sky, assuming uniform sky luminance distribution..

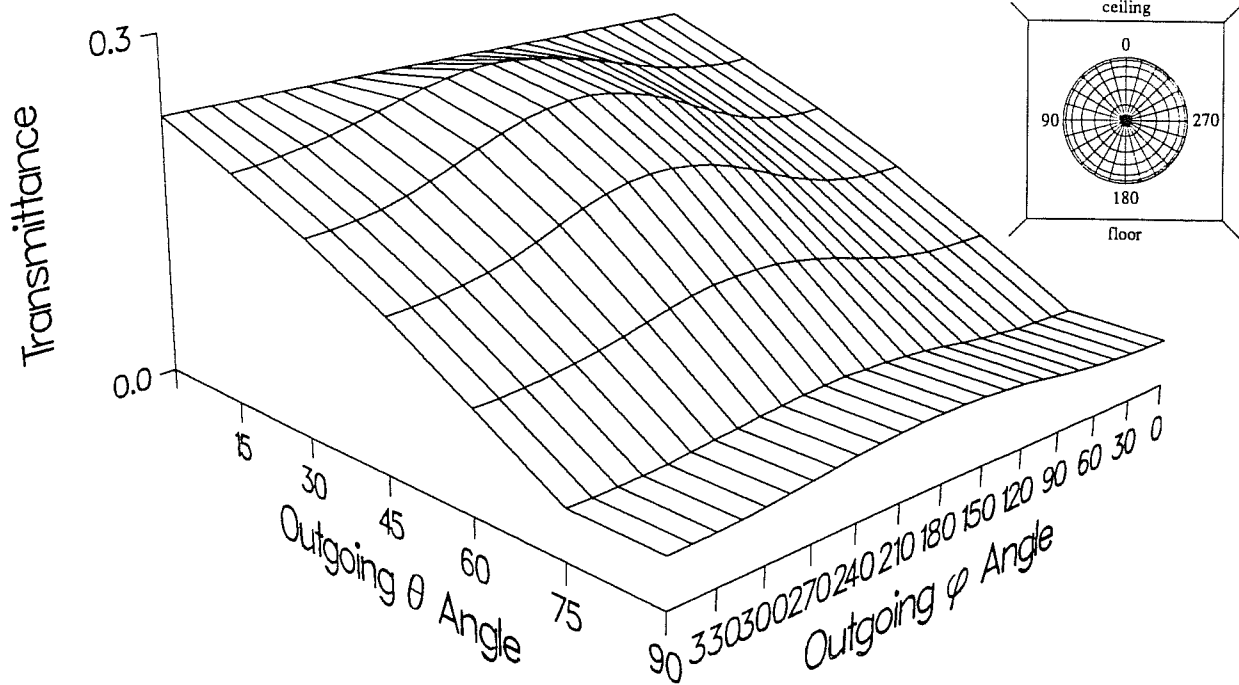

Figure 10. Transmitted distribution through a diffusive sample due to radiation from the sky, assuming the CIE overcast sky luminance distribution.

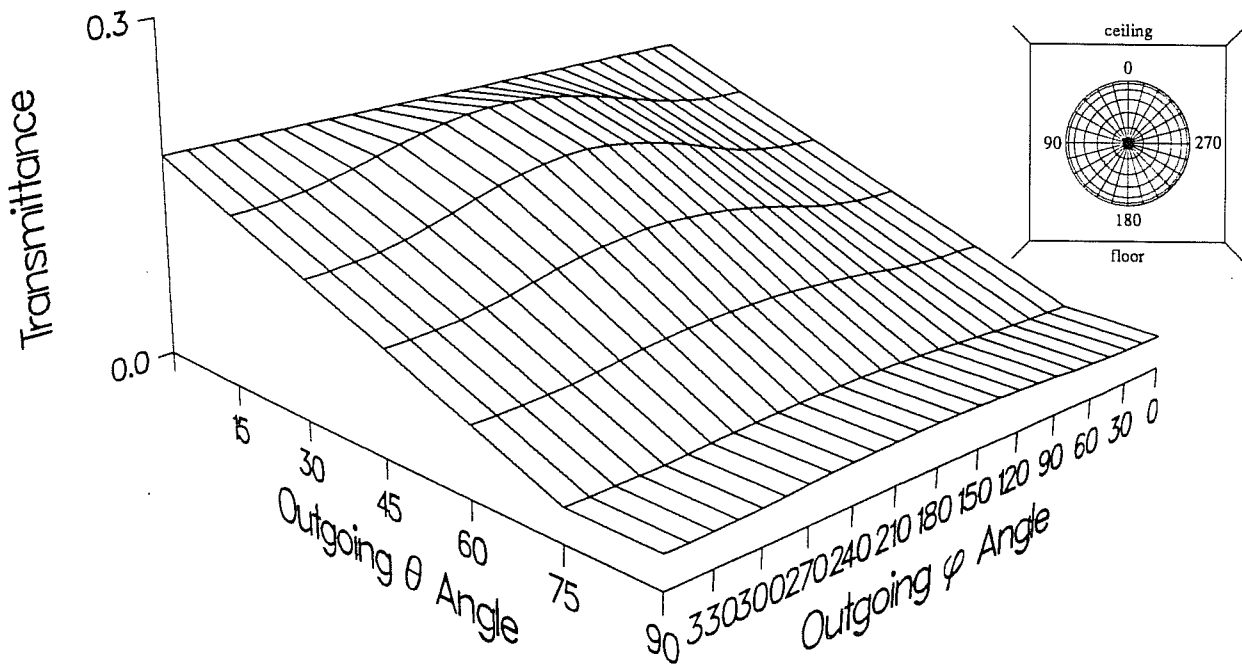

Figure 11. Transmitted distribution through a diffusive sample due to radiation from the sky, assuming the CIE clear sky luminance distribution for 0° solar azimuth from the normal to the fenestration system and 30° solar altitude.

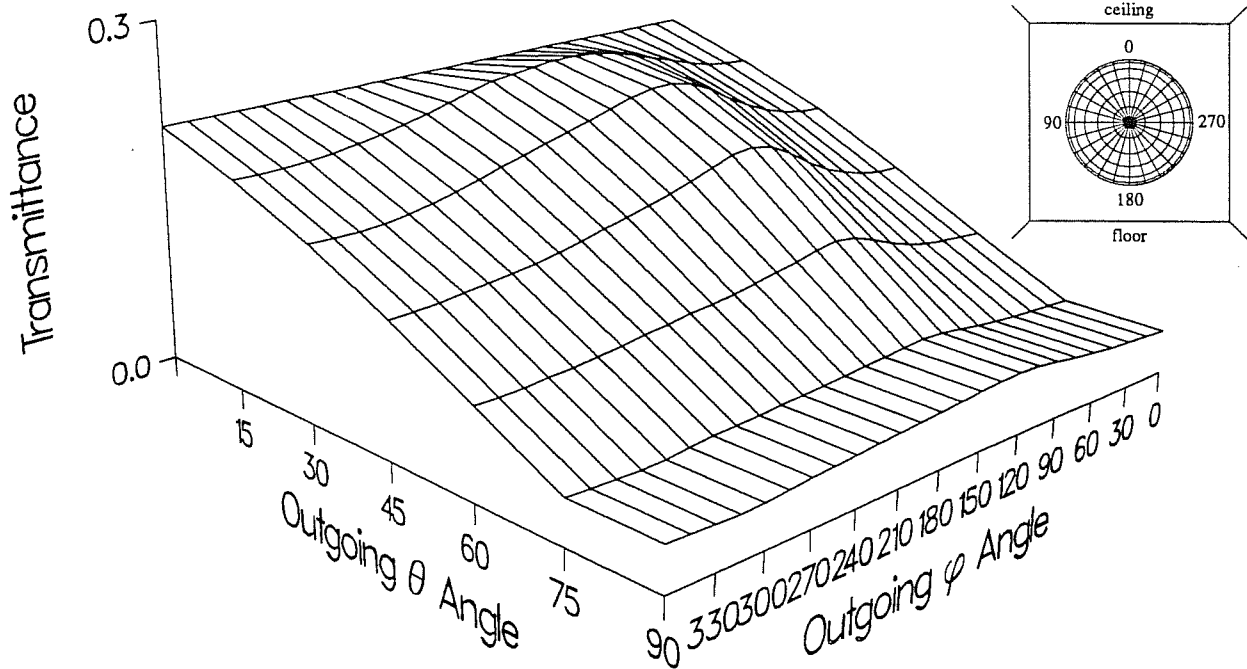

Figure 12. Transmitted distribution through a diffusive sample due to radiation from the sky, assuming the CIE clear sky luminance distribution for 60° solar azimuth from the normal to the fenestration system and 30° solar altitude.

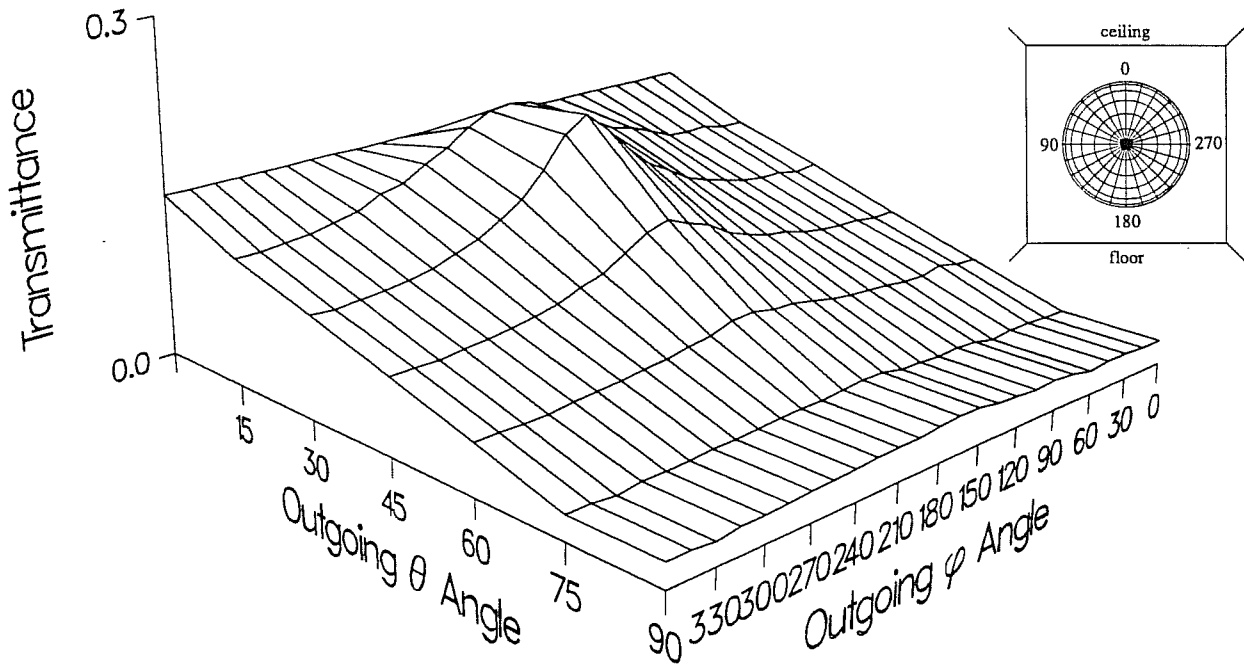

Figure 13. Transmitted distribution through a diffusive sample due to radiation from the sun, for 0° solar azimuth from the normal to the fenestration system and 30° solar altitude.

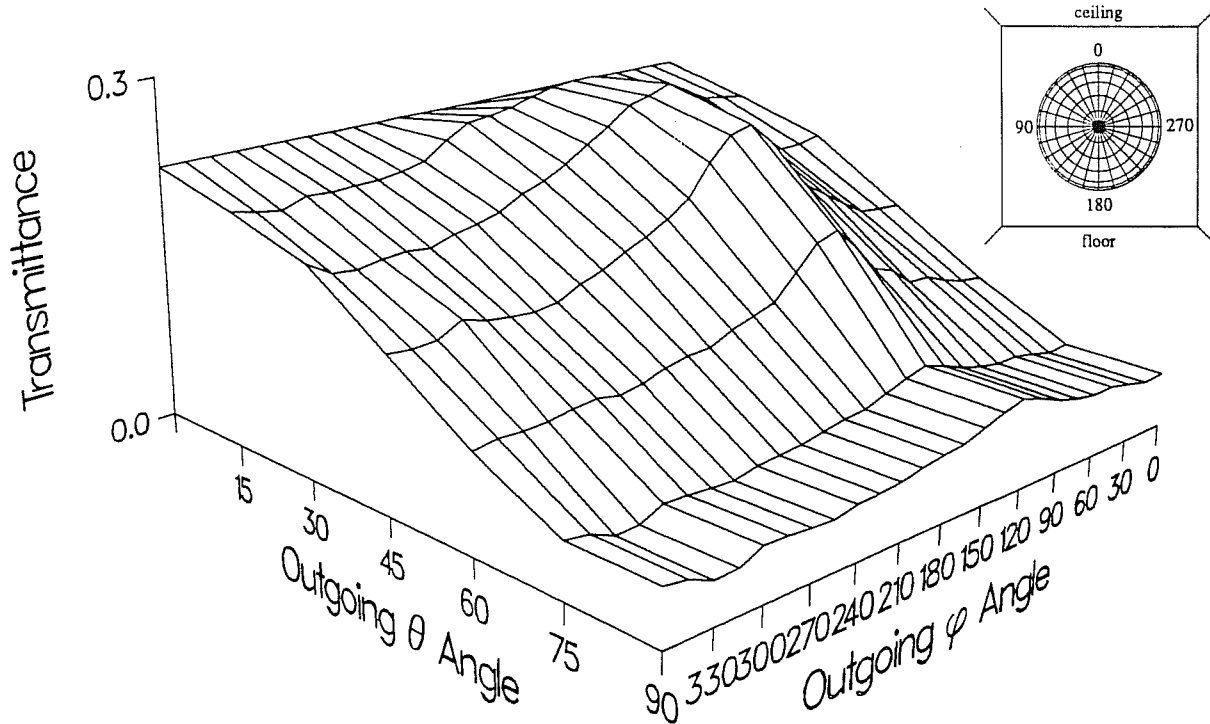

Figure 14. Transmitted distribution through a diffusive sample due to radiation from the sun, for 60° solar azimuth from the normal to the fenestration system and 30° solar altitude.

Several options of combining the transmittance distributions from the sun, sky and ground are being considered for the output of SSGTD, including the option of calculating the actual candlepower distribution. In the later case, however, additional input data will be necessary such as the turbidity and the water vapor content of the atmosphere, the local altitude from sea level, etc. With respect to the output format, the IES recommended standard format for electronic transfer of photometric data [IES 1986] is being considered.

A major limitation of the proposed approach is the lack of bidirectional transmittance data for fenestration systems. It is expected, however, that such data will be available in the future [Papamichael et al. 1988]. It would then be possible to perform a complete, concurrent analysis of indoors luminance environments, including consideration of both daylighting and electric lighting in a consistent way.

Acknowledgements

This work was supported by the Robert Thunen Memorial Scholarship of the Golden Gate Section of the Illuminating Engineering Society of North America and the Assistant Secretary for Conservation and Renewable Energy, Office of Building Technologies, Building Systems and Materials Division of the U.S. Department of Energy, under Contract No. DE-AC03-76SF00098.

References

- CIE 1970 CIE Technical Committee E-3.2. "Daylight: International Recommendation for the Calculation of Natural Light." CIE Publication No. 16, Commission Internationale de l'Eclairage, Paris, 1970.
- CIE 1973 CIE Technical Committee 4.2. "Standardization of Luminance Distribution of Clear Skies." CIE publication No. 22, Commission Internationale de l'Eclairage, Paris, 1973.
- IES 1981 Illuminating Engineering Society of North America. IES Lighting Handbook, Reference Volume.
- IES 1986 IES Computer Committee. "IES Recommended Standard File Format for Electronic Transfer of Photometric Data." IES Publication LM-63-1986, Illuminating Engineering Society of North America, 1986.
- Kim et als. 1986 Kim, J. J.; Papamichael, K.; Selkowitz, S.; Spitzglas, M.; and Modest, M. "Determining Daylight Illuminance in Rooms Having Complex Fenestration Systems." Presented at the 1986 International Daylighting Conference, Long Beach, California, and published in the proceedings.
- Papamichael et als. 1988 Papamichael, K.; Klems, J; and Selkowitz, S. "Determination and Application of Bidirectional Solar-Optical Properties of Fenestration Systems." Presented at the 13th National Passive Solar Conference, June 19-24, 1988, Massachusetts institute of Technology, Boston, Massachusetts, and published in the proceedings.